



## CEILING COOLING - TECHNICAL MANUAL



**FV KLIMA**



Ceiling cooling systems became an integral part of modern ceiling constructions for all types of office and residential buildings. It makes pleasant and healthy room climate and fully meets high requirements of modern architecture.



There is a cooled water flowing in the pipes/registers implemented in the ceiling structure. The water conducts energy away from a cooled room. Thanks to a big portion of radiant energy makes floor and walls cold, thus it creates a pleasant room climate with balanced distribution of temperatures.



## About the Company FV - Plast a.s.

The company FV Plast was established in 1990. From the beginning, it has been specializing in the production and related development of high quality pipes, fittings and fixtures for cold and hot water pipe installation, floor and central heating, large area radiant systems, renewable energy, as well as other applications in industry and agriculture.



We consider our emphasis on quality to be the foundation of our success. We use exclusively European, top quality materials, which are checked in our own specialist testing laboratory together with the resulting products.

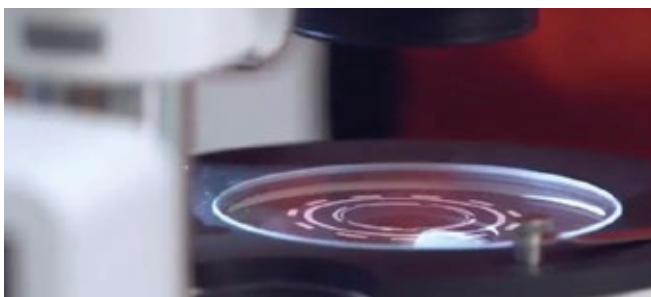

FV - Plast production technologies are the result of our own research and development. We make sure that our products meet the most demanding requirements for modern heating and cooling systems.



## TABLE OF CONTENTS

	Contens
1.	General information .....5
1.1.	Idea of ceiling cooling .....5
1.2.	Why to choose FV KLIMA? .....5
2.	Large-area radiating systems FV-KLIMA .....5
2.1.	Use of registers CoolFLEX .....6
2.2.	CoolFLEX, CoolGRID for ceiling metal soffits .....6
2.3.	CoolFLEX for plasterboard soffits .....7
2.4.	Active plasterboard panels CoolPLATE .....8
2.5.	Cooling system in plastering CoolGRID .....8
2.6.	Wall heating/cooling .....10
2.7.	Flooring heating/cooling with registers CoolFLEX .....12
3.	Hydraulic mounting .....13
3.1.	Concept norms .....13
4.	Concept of ceiling cooling .....13
4.1.	Concept recommendations .....13
4.2.	Basic recommendations for system concept .....13
4.3.	Pressure losses .....13
5.	Regulation .....14
5.1.	Regulation variants .....14
5.2.	Manual room thermostat .....14
5.3.	Condensation point convertor .....15
5.4.	Condensation point receptor .....15
5.5.	Technical data .....15
5.6.	Mounting scheme .....15
6.	Assembly process .....16
6.1.	Fittings .....16
6.2.	Manifold .....16
6.3.	Commencement .....16
7.	System units .....17
8.	References .....23

# TECHNICAL MANUAL

## 1. General information

Summer is coming. And in many European countries have already experienced days that encroach on that line between a lovely spring evening and one that's so uncomfortably hot it makes you want to stand under a cold shower. With increasing temperature we have to solve how to save our bodies before overheating. Best solution is to create ideal climate environment for all types of office and residential buildings. That is exactly our large-area radiant cooling and heating system FV KLIMA. Main goal is to create a pleasant climate and comfort during the all seasons. Pleasant climate without draught and noise positive affects our health and does contribute to increasing of employee work performance. FV KLIMA is suitable for all types of ceiling constructions and can be used to reconstruction. Like floor heating or wall heating, ceiling heating offers the greatest possible freedom of architecture and interior design.

### 1.1. Idea of ceiling cooling

System of ceiling cooling works on heat-sharing principle which is done by large-area active zone. There is a cooled water flowing in the pipes/registers, 16°C on the feeder and 18°C – 20°C on the return point. The water conducts energy away from area. Thanks to a big portion of radiant energy makes floor, walls as well as furniture cold, thus it creates a pleasant room climate with balanced distribution of temperatures. For providing sufficient performance and ideal thermal comfort there should be covered as much ceiling area as possible.

### 1.2. Why to choose FV KLIMA?

- The whole product range of FV KLIMA offers a solution for all types of ceiling constructions.
- A surface area cooling without causing draught and noise does contribute to increasing of employee work performance.
- It makes a pleasant room climate without overheated or overcold zones.
- It keeps and controls natural humidity level in the air, thus it is the ideal solution for all who suffer from allergy or asthma.
- FV KLIMA is not the only energetically economical system but also environment-friendly.
- Maximize operational efficiency by using of a renewable energy.
- Hidden installation makes no limit for any future refurbishments of the cooled areas.
- Offers a reliable operation without a maintenance.
- FV Plast not only provides a technical support, also offers a warranty for 10 years and indemnity insurance to compensate a potential loss.
- Thanks to cooperation with leading European measuring labs HKL Stuttgart and FTZ Zwickau system FV KLIMA offers relevant and provable technical data. We use the newest technical norms DIN EN 14037:2016 and DIN EN 14240 to determine cooling and heating performances.

## 2. Large-area radiating systems FV-KLIMA

Ceiling cooling/heating FV-KLIMA is made in several construction variations adapted to various ceiling constructions. New system **CoolFLEX** allows to be used for all types of radiating large-area systems for ceiling, wall, flooring:

### System CoolFLEX for metal soffits (full or acoustic)

System consists of thin cooling registers **CoolFLEX**, which are placed in metal soffit cassettes. Registers **CoolFLEX** are tailored according to project specifications. Cooling performance is 75 W/m<sup>2</sup>.

### System CoolFLEX for plasterboard ceilings (full or acoustic)

System consists of thin cooling registers **CoolFLEX**, which are placed on plasterboard panels and it offers simple and safe mounting. For providing the maximal performance there are used plasterboard panels with increased thermal conductivity (contains graphite). Docking system uses standard metal construction designed for plasterboard ceilings, using CD and UD metal profiles. Registers **CoolFLEX** are tailored according to project specification. Cooling performance is 70 W/m<sup>2</sup>.

### Active plasterboard panels CoolPLATE

Cooling pipes are placed in plasterboard grooves. Individual active cooling panels are tailored according to project specification. Active plasterboard panels **CoolPLATE** are installed to standard metal construction designed for lowered ceilings, using CD and UD profiles. Cooling performance is 60 W/m<sup>2</sup>.

### Under-plastering system CoolGRID

Cooling pipes **CoolGRID** are placed in ceiling plastering. Those are used in combination with core plastering or with hard plaster in the thickness of 10 to 20 mm. Cooling registers **CoolGRID** are created by placing pipes to bars directly during mounting. Cooling performance is 70 W/m<sup>2</sup> in dependence of pitch and used plastering substance.

### Wall cooling/heating CoolFLEX and CoolGRID

System FV KLIMA offers solutions of cooling/heating for all types of walls and wall constructions. It offers possibility of dry and wet process heating concept. For dry system the most appropriate ones are thin aluminium registers **CoolFLEX** fastened to metal construction and covered by plasterboard panels, eventually with active plasterboard panels **CoolPLATE**. The third option is use of under-plastering system **CoolGRID**.

### Flooring heating with CoolFLEX

Flooring heating/cooling with thin aluminium perforated register **CoolFLEX** belongs among wet processes with minimal cut-off humidity from the point of the system mounting view. Registers are embedded by cement self-levelling coating (class CT-C30-F7 according to ČSN EN 13 813). By means of that, total construction height of heating is up to 1 cm.

conventional air conditioning

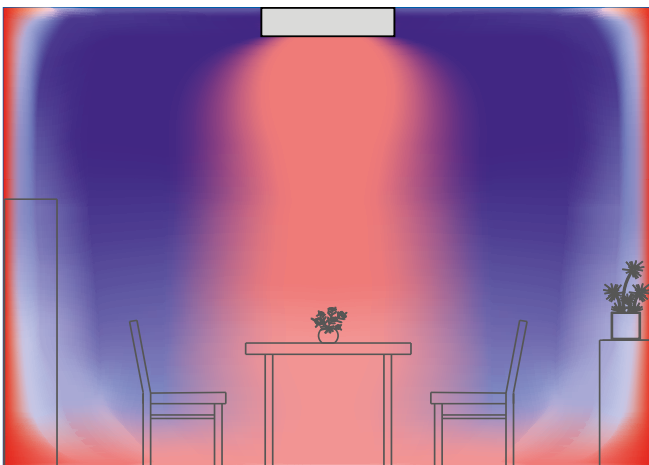

ceiling cooling system FV KLIMA

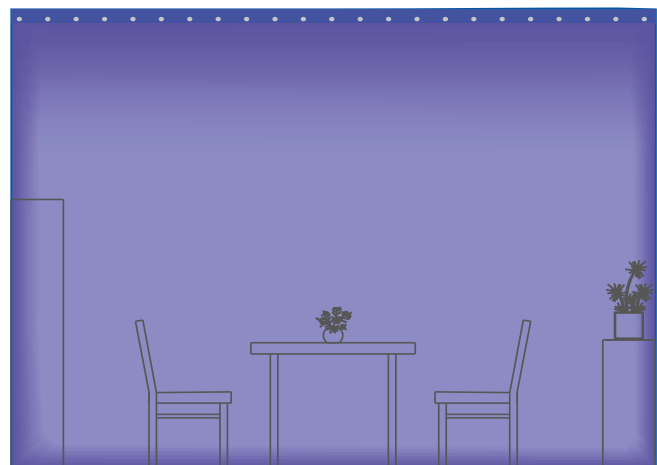

## 2.1. Use of registers CoolFLEX

**CoolFLEX** is patented system of aluminium registers. It consists of polybutylene pipe with air-barrier fused between two thermal conductible aluminium foils, which provides high performance. Aluminium foil provides balanced spread of heat or cold in whole active area of the ceiling, wall or flooring. It also helps to improve reaction of the whole register in case of fire, which allows to use registers even in the environment with higher fire prevention requirements.

System **CoolFLEX** can be installed to cassette ceilings, acoustic panels or directly place to plasterboard panel, fastened to standard metal construction designed for dry constructing. Possibilities for use are basically unlimited.

It allows cooling or heating in dependance from water and so if there is flowing cold or hot water in the registers. Individual registers in room can be connected to pipework distributor by quick couplings for simple and safe mounting as well as those can be connected one to another and so make a solution for simple or even shaped rooms.

## 2.2. CoolFLEX, CoolGRID for ceiling metal soffits

System **CoolFLEX** and **CoolGRID** for metal soffits is designed as well for light mounted constructions with perforated or full metal ceiling cassettes. It will find its use wherever it is necessary to keep whole-area access to the technologies installed above the ceiling soffit. This construction is usually used in offices, health care institutions and industrial plants.

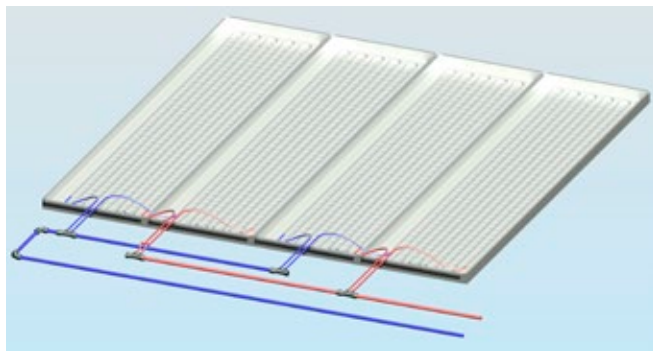

### CoolFLEX full matting for cassette

Metal soffits are made in various construction concepts depending from producer. System **CoolFLEX** is thanks to dimension range very variable and so it allows installation for all types of metal soffits.

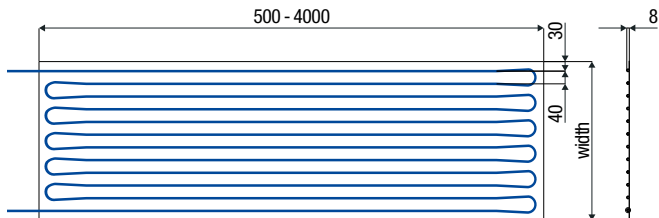

### CoolFLEX perforated matting for cassette

This variant serves for constructions with requirement to improve acoustic features of the room. For maintaining of acoustic suppression of perforated metal cassettes is the matting in the whole area perforated by holes with diameter of 20 mm.

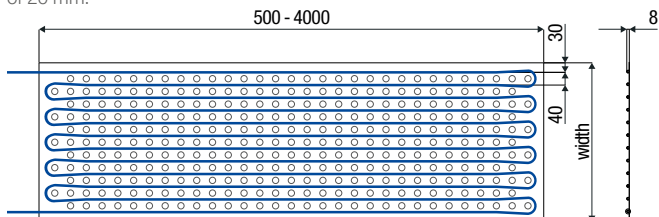

### CoolGRID matting for acoustic cassette

This variant serves for constructions with requirement to stay maximum acoustic features of the room. Thanks to dimension range is matting very variable and so it allows installation for all types of metal soffits.

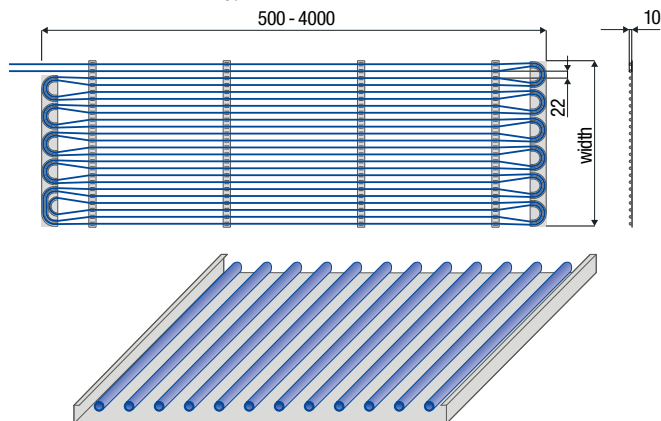

### Technical datas

	<b>CoolFLEX</b>	<b>CoolGRID</b>
length	500 - 4000 mm	500 - 4000 mm
width	180, 260, 340, 420, 500, 580, 660	128, 172, 216, 260, 304, 348, 392, 436, 480, 524, 568, 612
depth	8,5 mm	10 mm
cooling performance EN 14240	75 W/m <sup>2</sup> (16/19/26°C)	70 W/m <sup>2</sup> (16/19/26°C)
heating performance EN 14037	89 W/m <sup>2</sup> (37/33/20°C)	82 W/m <sup>2</sup> (37/33/20°C)
pipe	PB 8x1 mm, pitch 40 mm	PB 8x1 mm, pitch 22 mm
water content	0,7 l/m <sup>2</sup>	1,3 l/m <sup>2</sup>
weight excl. water	1,03 kg/m <sup>2</sup>	1,55 kg/m <sup>2</sup>
weight incl. water	1,73 kg/m <sup>2</sup>	2,85 kg/m <sup>2</sup>
max. working pressure	4 bar	4 bar
max. working temperature	50 °C	50 °C
length of feed	1,2 m	1,2 m

### Performance diagram

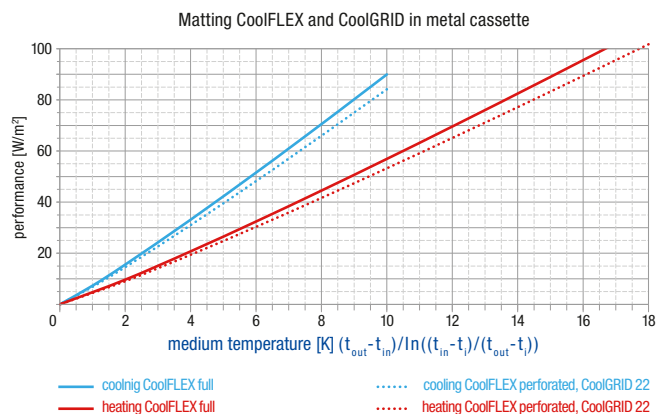

## 2.3. CoolFLEX for plasterboard soffits

System consists of thin cooling registers **CoolFLEX**, which are placed on plasterboard panels and it offers simple and safe mounting. For securing of maximal performance there are used plasterboard panels with increased thermal conductivity (including graphite). For docking the system uses standard metal construction designed for plasterboard ceilings, using CD and UD metal profiles.

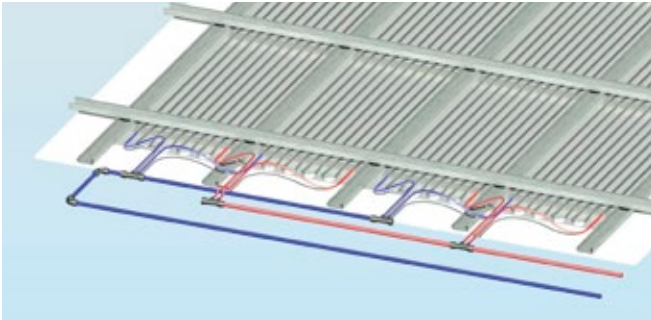

### Description and use

Main part of the system is register **CoolFLEX** made from polybutylene pipe 8x1 mm fused in a thin aluminium foil. Each register has along the longer sides adhesive layer which serves as a fastener of the register to carrying profiles. After installation of registers and its connecting to main distributing duct, the ceiling is closed by special plasterboard panels with increased thermal conductivity – FV Thermalpanel.

### Assembly

- prepare metal carrying construction for PBD ceilings. Spacing of mounting sections is 500 mm.
- install central distribution from pipe FV COOLING 16x2 mm into area of the soffit
- stick registers **CoolFLEX** to mounting sections and connect those to central distribution by use of quick couplings
- run test of the sealing and test of regulation functionality
- close ceiling with plasterboard panels with thermal conductivity according to project documentation.

#### DETAIL OF THE MATTING

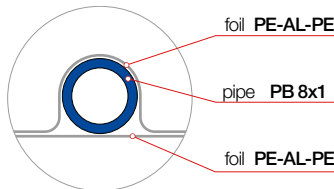

### 2 variants depending on type of usage:

- **CoolFLEX** full matting for plasterboard

It is designed for placing on plasterboard panels and provides maximal performance and fire resistance.

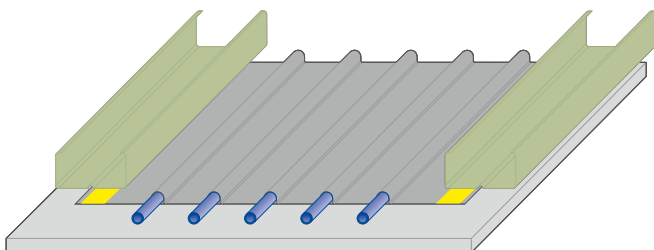
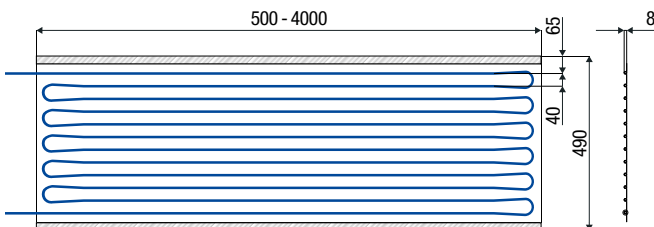

### ■ CoolFLEX perforated matting for plasterboard

It is designed for placing on perforated plasterboard panels. For maintaining of acoustic suppression of perforated metal cassettes, the matting is perforated in whole length by holes with diameter of 20mm.

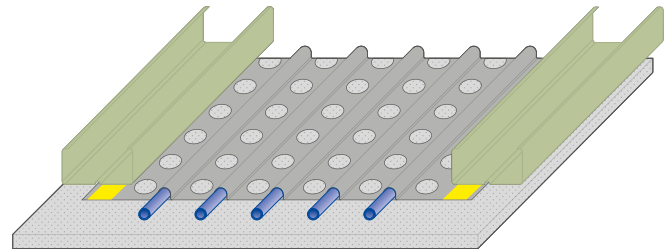
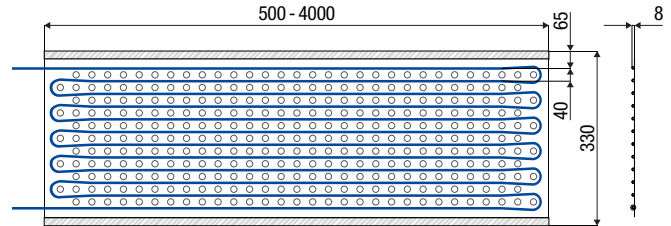

### Technical datas

length	500 - 4000 mm
width	490,
depth	8,5 mm
cooling performance EN 14240 (panel $\lambda = 0,45/0,30$ dpt.10 mm) EN 14240	68/63 W/m <sup>2</sup> (16/19/26°C)
heating performance EN 14037 (panel $\lambda = 0,45/0,30$ dpt.10 mm) EN 14037	79/73 W/m <sup>2</sup> (37/33/20°C)
pipe	PB 8x1 mm, pitch 40 mm
water content	0,7 l/m <sup>2</sup>
weight of matting excl. water	1,03 kg/m <sup>2</sup>
weight incl. water	1,73 kg/m <sup>2</sup>
max. working pressure	4 bar
max. working temperature	50 °C
length of feed	1,2 m
carrying profiles pitch	500 mm
fire resistance	B-s1, d0

### Performance diagram

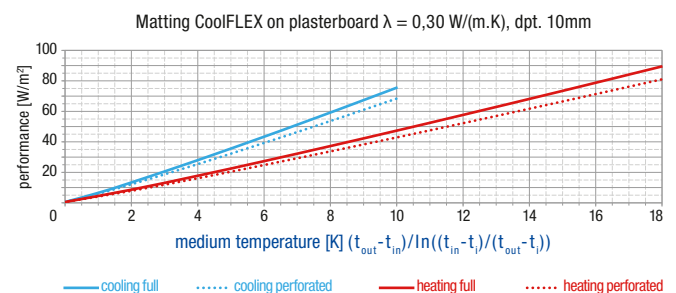
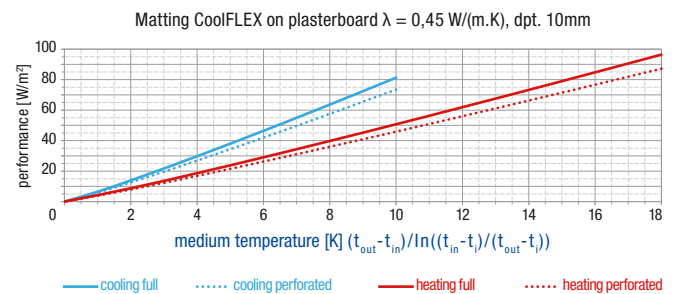

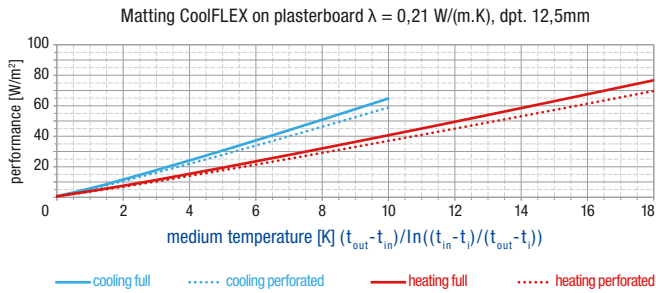

## 2.4. Active plasterboard panels CoolPLATE

Cooling pipes are placed in plasterboard grooves. Individual active cooling panels **CoolPLATE** are tailored according to project specification. Active plasterboard panels are installed to standard metal construction designed for lowered ceilings, using CD and UD profiles.

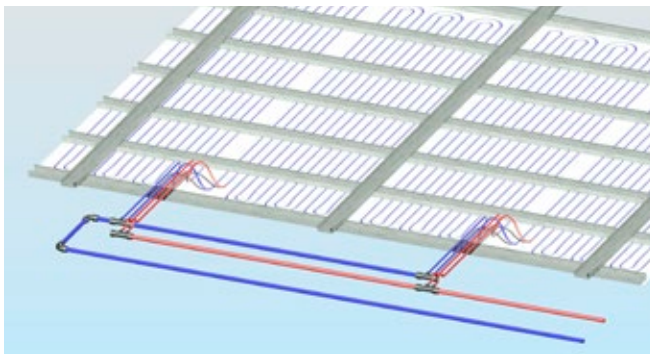

### Description and use

Active plasterboard panels **CoolPLATE** are made in full or acoustic variations. They are used in the rooms, where ceiling has got many embedded luminaires, air diffusers, reproducers and other technologic transmissions. For easier and safe mounting there is on the front side pre-drawn line of pipe and marked embedding elements installation points.

### Assembly

- prepare metal carrying construction for PBD ceilings. Spacing of mounting sections is 333 mm.
- install central distribution from pipe FV COOLING 16x2 mm into area of the soffit
- fasten active plasterboard panels **CoolPLATE** to mounting sections and connect those to central distribution by use of quick couplings
- run test of the sealing and test of regulation functionality.

### DETAIL OF PANEL

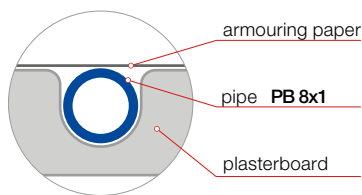

### Standard formats of the active panels CoolPLATE

Active panels are made in full or perforated variants in four basic dimensions. If there's placed a requirement to omit spaces with luminaires and transmissions, panels are tailored according to the particular order.

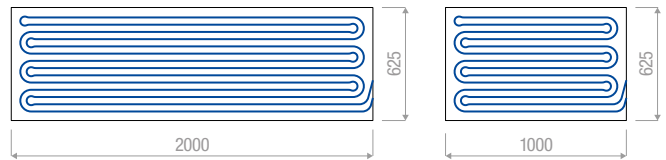
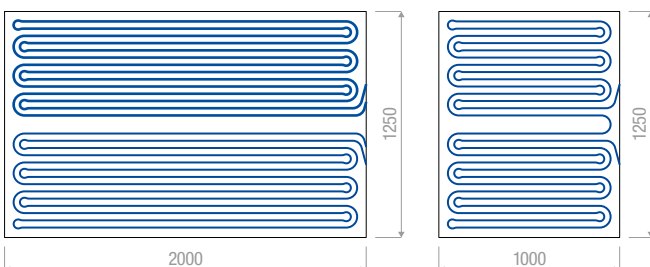

### Technical datas

length	1000, 2000 mm
width	625, 1250 mm
depth	12,5 mm
cooling performance EN 14240	60 W/m <sup>2</sup> (16/19/26°C)
heating performance EN 14037	70 W/m <sup>2</sup> (37/33/20°C)
pipe	PB 8x1 mm, pitch 40 mm
water content	0,7 l/m <sup>2</sup>
weight of matting excl. water	10,8 kg/m <sup>2</sup>
weight of matting incl. water	11,5 kg/m <sup>2</sup>
max. working pressure	4 bar
max. working temperature	50 °C
length of feed	1,2 m
carrying profiles pitch	333 mm

### Performance diagram

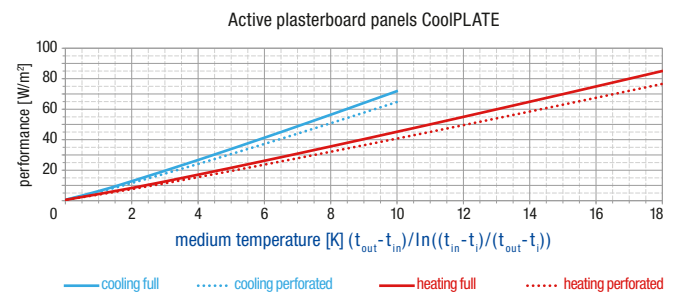

## 2.5. Cooling system in plastering CoolGRID

It consists from polybutylene pipes 8x1mm placed in plastic grooves fastened to the ceiling. Whole register **CoolGRID** is subsequently being plastered by reinforced plastering with thickness 2-3 cm.

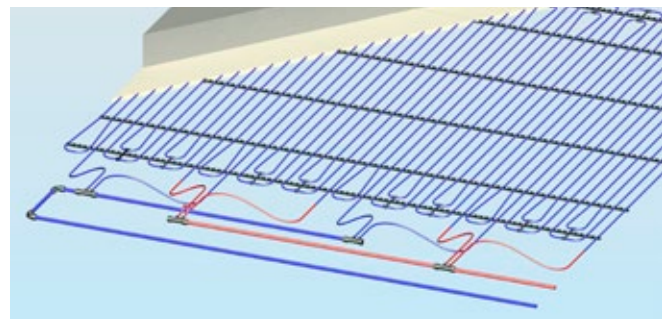

### Description and use

It is used in plastered ceiling constructions. System is mounted directly at work-place. This way of installation is more demanding, however it offers to adapt solution for the real arrangement and changes. A suitable alternative to this is delivery of final product – mattings **CoolGRID** made according to particular requirements.



### CONSTRUCTION DETAIL

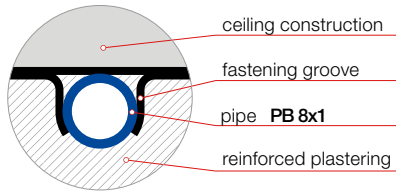

### Assembly modules

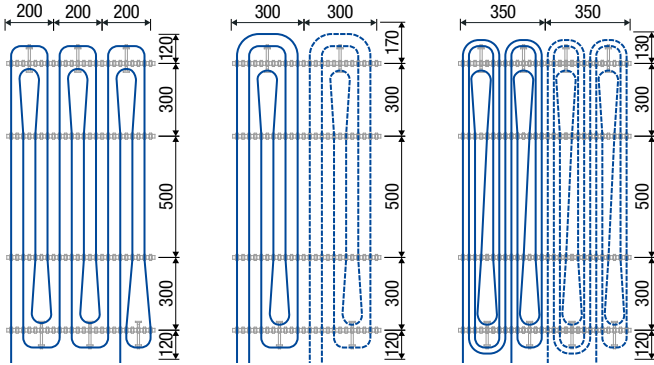

### Material consumption chart

pipes pitch	50 mm	40 mm	29 mm
groove	R25 - 3 pcs/m <sup>2</sup>	R20 - 1,3 pcs/m <sup>2</sup>	R25 - 3 pcs/m <sup>2</sup>
arc console	3 pcs/m <sup>2</sup>	- *	4 pcs/m <sup>2</sup>
pipe 8x1 mm	20 m/m <sup>2</sup>	25 m/m <sup>2</sup>	35 m/m <sup>2</sup>

\* groove type R20 isn't compatible with arc consoles

### System CoolGRID assembly procedure

- Ceiling must comply to base flatness conditions pursuant to ČSN EN 13914-2 (5mm/2m). Base ceiling concrete must be hard and dry, it is necessary to remove any dirt and flatten jogs.
- In the rooms where the ceiling cooling system is to be installed there should be processed base in line with technological regulations of plastering substance supplier.
- Install central distribution from pipe FV COOLING 16x2 mm.
- Place docking grooves for pipe Ø 8x1 mm in required spacing to the area of ceiling. The best way to place grooves is to fasten those with dowel Ø 5 mm or other appropriate way.
- Place pipe FV COOLING 8x1 mm to the grooves and connect that to central distribution with use of quick couplings.
- Run test of the sealing and test of regulation functionality.

### Plastering the system CoolGRID

- For plastering of the ceiling we recommend to use appropriate gipsum plaster or core plaster substance with thermal conductivity relevant to the project. Application is to be regulated by substance suppliers notes.
- Minimal thickness of the plastering is 20 mm.
- Sizes of dilatation units are to be regulated by used plastering substance notes.
- Within plastering there must be suitable pressure in the system and it is necessary to perform checkouts of the pressure in system.

### Technical datas

length	unlimited
width	according to pitch
depth	20 - 30 mm
cooling performance EN 1264	up to 70 W/m <sup>2</sup> (16/19/26°C)
heating performance EN 1264	up to 80 W/m <sup>2</sup> (37/33/20°C)
pipe	PB 8x1 mm
max. working pressure	4 bar
max. working temperature	50 °C
length of feed	1,2 m

### Performance diagram

In the individual diagrams there are stated performances for individual pitches and plastering substances. Label "cooling 0,8, dpt. 10" means, this is performance arc of the cooling system covered by plastering substance with thermal conductivity 0,80 W/(m.K) with pipes covering 10 mm.

System CoolGRID in plastering - pitch 50mm, for various plasterings

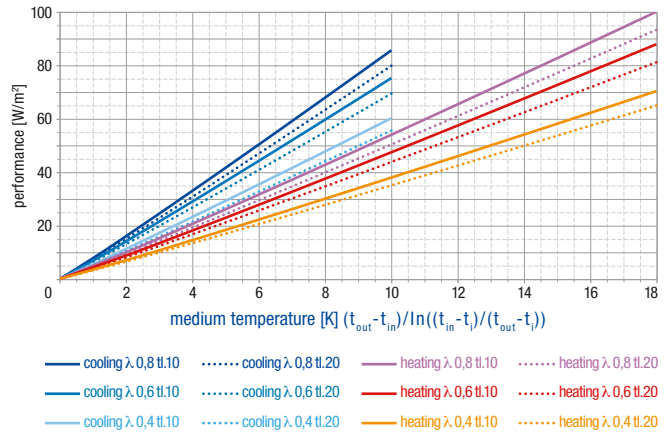

System CoolGRID in plastering - pitch 29mm, for various plasterings

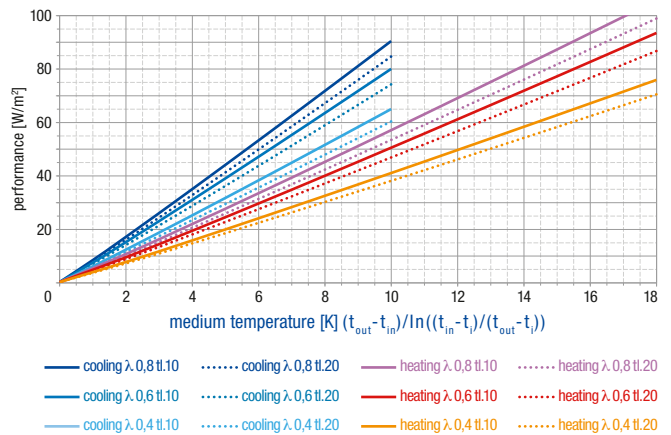

## 2.6. Wall heating/cooling

System FV KLIMA offers cooling/heating solution for all types of walls and wall constructions. It offers possibility for application by dry or wet process. For dry process the most suitable ones are thin aluminium registers **CoolFLEX** fastened to the metal construction and covered by plasterboard panels, eventually by active plasterboard panels **CoolPLATE**. The third option is to use under-plastering system **CoolGRID**.

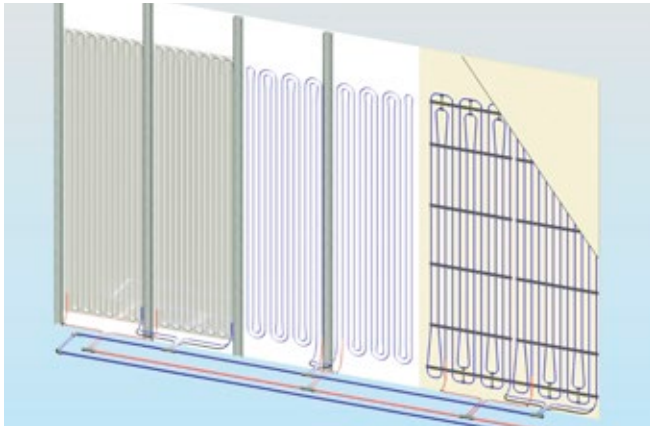

### Plasterboard mounted walls with system CoolFLEX

The main active element of the system are thin aluminium registers **CoolFLEX**, which are stuck from the fair-face side to CW profile of the standard metal construction for mounted walls and covered by plasterboard similarly as with the system of ceiling cooling/heating with use of registers **CoolFLEX**. Details about register **CoolFLEX** are stated in the chapter 2.1.

Each of **CoolFLEX** registers has an adhesive layer on the both sides, which serves to stick register to CW profiles. For getting the maximal performance there are used plasterboard panels with increased thermal conductivity FV KLIMA Thermalpanel. Standard pitch of the profiles is 625 mm.

#### DETAIL OF THE MATTING

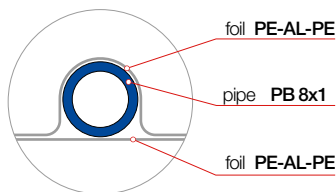

#### Assembly

- Prepare metal carrying construction for PBD ceilings. Spacing of mounting sections is 625 mm.
- Install central distributor from pipe FV COOLING 16x2 mm
- Fasten active plasterboard panels **CoolFLEX** to mounting sections and connect those to central distribution by use of quickcouplings
- Run test of the sealing and test of regulation functionality
- Close the wall with plasterboard panels with thermal conductivity according to the project documentation.

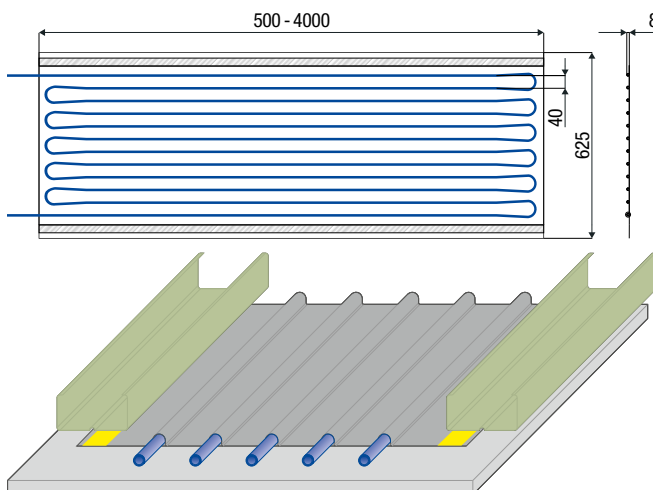

### Active plasterboard panels CoolPLATE

The system with active plasterboard panels is the same as the system of ceiling cooling is, and that is such, as with the idea, construction and fastening. Active plasterboard panels **CoolPLATE** are fastened to standard metal construction designed for mounted walls. It is made in full or perforated variant in four basic dimensions. If there is a requirement for omitting in the areas of holes and transmissions, panels are tailored according to specific order.

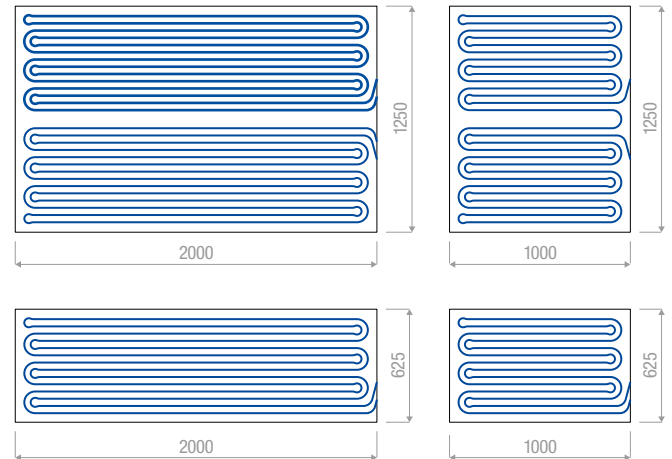

#### Assembly

- Prepare metal carrying construction for PBD ceilings. Spacing of mounting sections is 312,5 mm.
- Install central distributor from pipe FV COOLING 16x2 mm.
- Fasten active plasterboard panels **CoolPLATE** to mounting sections and connect those to central distribution by use of quickcouplings.

### System CoolGRID in plastering

It consists of polybutylene pipes Ø8x1 mm placed in plasterboard grooves fastened to the wall. Whole register **CoolGRID** is plastered by reinforced plastering of thickness 2-3 cm.

It is used in plastered wall constructions. System is mounted directly at workplace. This way of installation is more demanding, however it offers to adapt solution for the real arrangement and changes. A suitable alternative to this is delivery of final product – mattings made according to particular requirements.

#### Assembly

- Ceiling must comply to base flatness conditions pursuant to ČSN EN 13914-2 (5mm/2m). Base ceiling concrete must be hard and dry, it is necessary to remove any dirt and flatten jogs.
- In the rooms where the wall cooling/heating system is to be installed there should be processed base in line with technological regulations of the plastering substance supplier.
- Install central distribution from pipe FV COOLING 16x2 mm.
- Place docking grooves for pipe 8x1 mm in required spacing to the area of wall. The best way to place grooves is to fasten those with coaks Ø 5 mm or other appropriate way.
- Place pipe 8x1 mm to the grooves and connect that to central distribution with use of quick couplings.
- Run test of the sealing and test of regulation functionality.

#### Plastering the system CoolGRID

- For plastering of the ceiling we recommend to use appropriate hard plaster or core plaster substance with thermal conductivity relevant to the project. Application is to be regulated by the substance suppliers notes.
- Minimal thickness of the plastering is 20 mm.
- Sizes of dilatation units are to be regulated by the used plastering substance notes.
- Within plastering there must be suitable pressure in the system and it is necessary to perform checkouts of the system pressure.

## Placing pipes into grooves

For pitch of 50 and 29 mm there is used fastening groove with pitch 25 mm and arc holder clamps, for pitch 40 mm it is groove with pitch 20 mm without holder clamps (see chart of the material consumption).

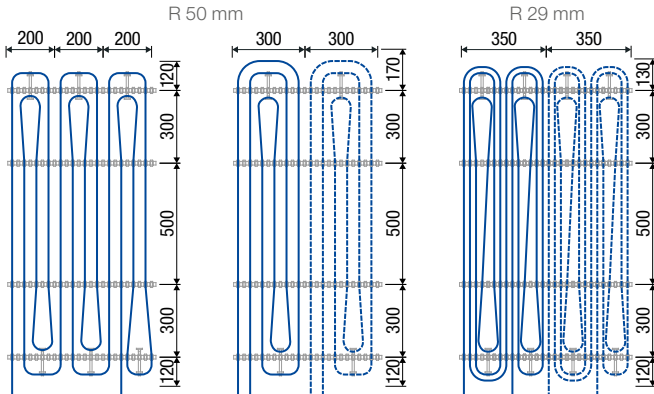

## Material consumption

pipes pitch	50 mm	29 mm
rail	R25 - 3 pcs/m <sup>2</sup>	R25 - 3 pcs/m <sup>2</sup>
arc console	3 pcs/m <sup>2</sup>	4 pcs/m <sup>2</sup>
pipe 8x1 mm	20 m/m <sup>2</sup>	35 m/m <sup>2</sup>

## Technical data

	<b>CoolFLEX</b>	Active panels	Pipe in plastering
length	500 - 4000 mm	1000, 2000 mm	unlimited
width	625 mm	625, 1250 mm	according to pitch
thickness	8,5 mm	12,5 mm	20-30 mm
cooling performance EN 1264	up to 50 W/m <sup>2</sup> (16/19/26°C)	44 W/m <sup>2</sup> (16/19/26°C)	up to 56 W/m <sup>2</sup> (16/19/26°C)
heating performance EN 1264	up to 94 W/m <sup>2</sup> (37/33/20°C)	70 W/m <sup>2</sup> (37/33/20°C)	up to 104 W/m <sup>2</sup> (37/33/20°C)
pipe	PB 8x1 mm, pitch 40 mm	PB 8x1 mm, pitch 40 mm	PB 8x1 mm
water content	0,7 l/m <sup>2</sup>	0,7 l/m <sup>2</sup>	0,028 l/lm of pipe
weight of matting excl. water	1,03 kg/m <sup>2</sup>	10,8 kg/m <sup>2</sup>	-
weight of matting incl. water	1,73 kg/m <sup>2</sup>	11,5 kg/m <sup>2</sup>	-
max. working pressure	4 bar		
max. working temperature	50 °C		
feed length	1,2 m	1,2 m	-
carrying profiles pitch	625 mm	625 mm	500 mm

## Performance diagram

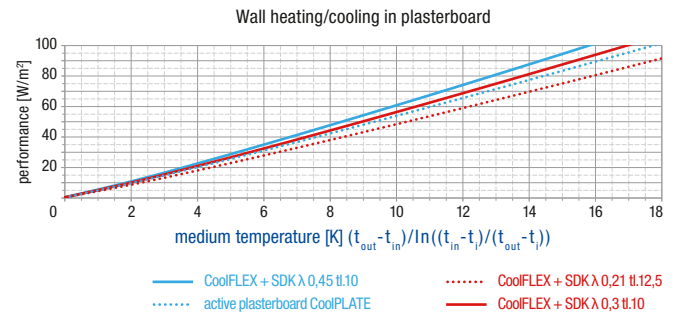

In the individual diagrams there are stated performances for each kind of the pitch and the plasterboard substance. Labelling "cooling λ 0,8 dpt.10" means, there is a performance curve of the cooling system covered by plastering substance with thermal conductivity 0,80 W/(m.K) with pipes covering 10 mm. In the case of wall heating/cooling, the heating and the cooling performance within same temperature difference is basically identical.

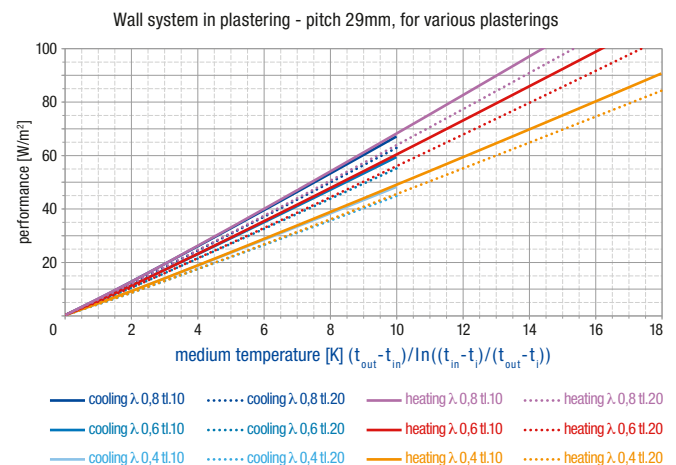
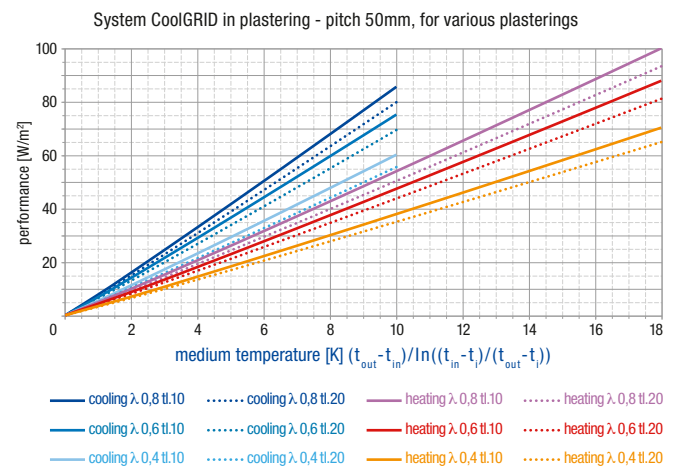

## 2.7. Flooring heating/cooling with registers CoolFLEX

Flooring heating/cooling with thin aluminium perforated register **CoolFLEX** belongs from the point of view of application system among the wet processes with minimal cut-off humidity. Registers are embedded with cement self-levelling coating (class CT-C30-F7 according to ČSN EN 13 813). By means of that, total construction height of heating is up to 1 cm.

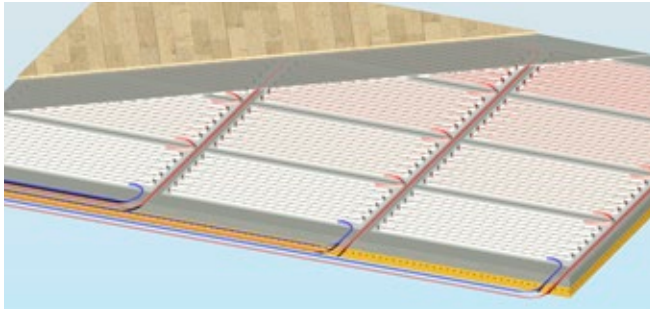

Main active element of the system are thin aluminium registers **CoolFLEX** embedded in the flooring. Used aluminium foil distributes heat in the whole area of the register and so it allows to be covered with minimal layer of the coating.

Flooring heating CoolFLEX finds its use mainly within heating systems reconstructions, changing to modern economy sources of the heating.

Details about register CoolFLEX to be found in the chapter 2.1.

### DETAIL OF THE MATTING

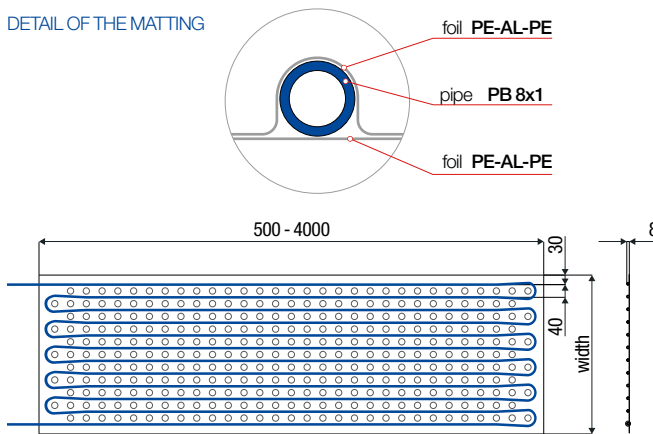

### Technical data

length	500 - 4000 mm *
width	180, 260, 340, 420, 500, 580, 660
thickness	8,5 mm
cooling performance	up to 40 W/m <sup>2</sup> (16/19/26°C)
heating performance	up to 90 W/m <sup>2</sup>
pipe	PB 8x1 mm, pitch 40 mm
water content	0,7 l/m <sup>2</sup>
weight of matting excl. water	1,03 kg/m <sup>2</sup>
weight of matting incl. water	1,73 kg/m <sup>2</sup>
max. working pressure	4 bar
max. working temperature	50 °C
feed length	1,2 m

\*Individual registers can be made in various lengths (multiplies by 50 mm).

## Application

- Registers **CoolFLEX** with pipe 8x1 mm are connected to each other within one circle having maximal area 4,5 m<sup>2</sup>. Manifold type PUSH 8 (vis. scheme) is connected to each of such a circle.
- Each circle should be started within the most cooled wall and should be advancing into the room (see picture).
- Manifold should be normally placed in the box on wall or inside the wall

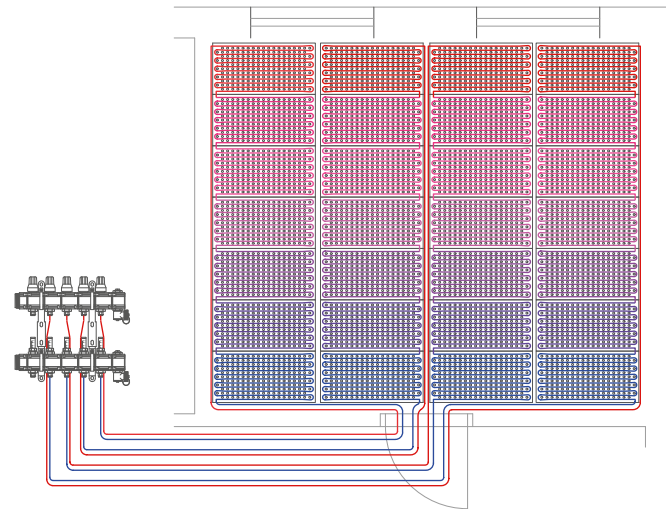

## Assembly

- Base must comply to flatness conditions pursuant to ČSN EN 13914-2 (5mm/2m). Base ceiling concrete must be hard and dry, it is necessary to remove any dirt and flatten jogs.
- Penetrate flooring with appropriate preparation according to base type.
- Fasten registers **CoolFLEX** with bothside adhesive tape and connect those to distributor.
- Run test of the sealing.
- Perform casting of the flooring by self-levelling coating in two layers with total minimal thickness 10 mm.
- Be advised not to step directly on registers **CoolFLEX**. For movement it is necessary to lay corridors from reinforced polystyrene with minimal thickness 50 mm.

## Performance diagram

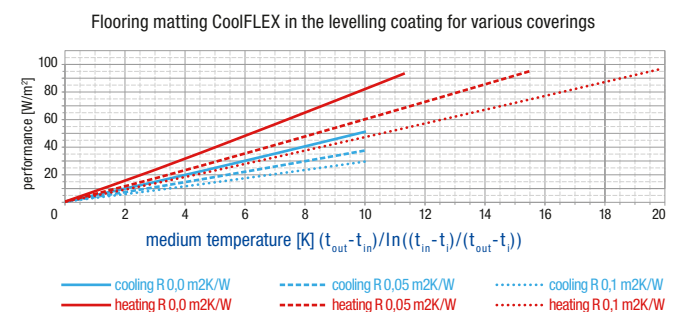

### 3. Hydraulic mounting

#### 3.1. Concept norms

System of ceiling cooling are thanks to area dividing into relatively small sections and great flow volume specific, but if there is compliance to several basic rules, we are able to create reliable and safe system.

##### 1. All circuits are of same length

All circuits connected to the central distribution must be of the same length. If there is a combination of different circuit's sizes it is necessary to determinate the longest one and the rest should be adequately prolonged by interconnection with another circuit, eventually by non-active pipe placed beneath the soffit.

##### 2. Application according to Tiechelmann

In respect of regulation elements absence in the central distribution it is necessary for all the circuits to have pressure loss at manifold in relation to the regulation valve. To achieve this it is necessary to connect circuits to the central distribution within the principle of Tiechelmann. It means that the first circuit on the feed point is at the same time the last on return point, the second one is the penultimante etc.

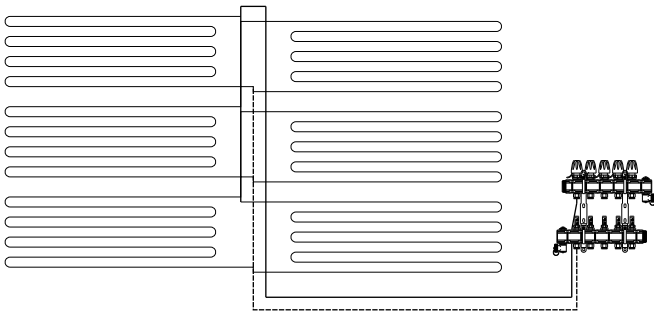

##### 3. Maintaining duct intersection in the whole sub-circuit

For safe loading, deaeration and subsequent transport it is necessary to avoid decreasing of the flow volume intersection in the whole area of the sub-circuit. Emerging turbulences in narrowings cause insufficient flush and deaeration of the system and cause unequal distribution of temperatures and system unreliability. For construction of the central distribution of the ceiling cooling it is recommended to use exclusively fittings FV KLIMA of line COOLING, eventually fittings of a similar construction.

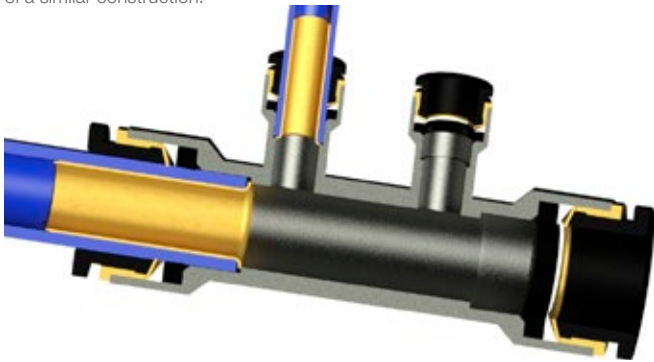

### 4. Concept of ceiling cooling

#### 4.1. Concept recommendations

Within the concept it is needed to bear in mind temperature of the condensation point, where a ceiling dew may appear. For achieving of the maximal cooling performance with respect to possible risk of condensation it is recommended to keep heat range of the cooling water 16/19°C.

Parameters increasing risk of the condensation point appearance:

- feed water temperature lesser than 16°C
- increased humidity in the area (cooking, more persons in the area and such)
- significant differences between feed air humidity and the area humidity
- insufficient dehumidification of the fresh air vented to the room

For preventing of cooling system condensation it is necessary to install condensation point receptors.

#### 4.2. Basic recommendations for system concept

- to prevent condensate appearance, ceiling must be laid out in such a way, so feed water temperature would be always above condensate point temperature
- required height of the soffit construction within plasterboard and compartment ceilings is 6 – 20 cm
- in case of the system cooling plastering, it is recommended total thickness of plastering 2 cm
- optimal length of circuit with pipe  $\varnothing 8 \times 1 \text{ mm}$  is 20 – 40 m
- optimal active cooling area size for one sub-circuit of distributing pipe  $\varnothing 16 \times 2 \text{ mm}$  is 10 – 15 m<sup>2</sup>
- up to 15 cooling sub-circuits can be connected per one manifold
- each sub-circuit must be equipped with regulating valve with actuator
- condensation point receptor must be placed in each room on the feed duct
- it is recommended to provide air ventilation with modified air
- if using heating system it is recommended to use insulant material of thickness 3 – 5 cm above cooling registers.
- if using ceiling system for heating is temperature of heating water limited to 45 °C.
- system can be fed by drinkable water without mechanical dirt
- dilatation of cooling/heating ceilings must be designed and applied according to technical layouts and recommendations of plastering substances and plasterboard panels producers.

#### 4.3. Pressure losses

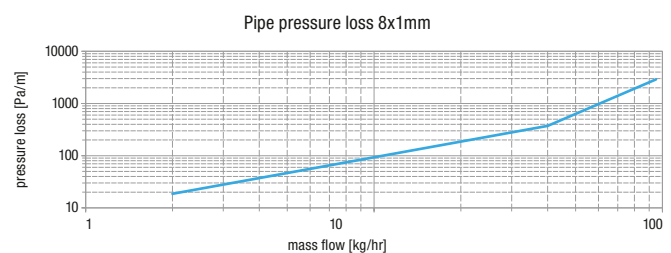
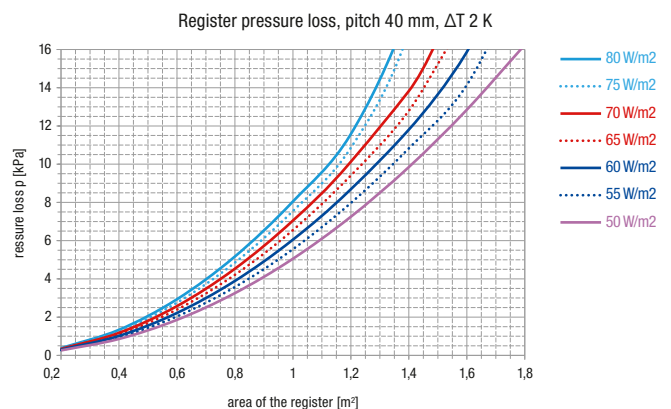
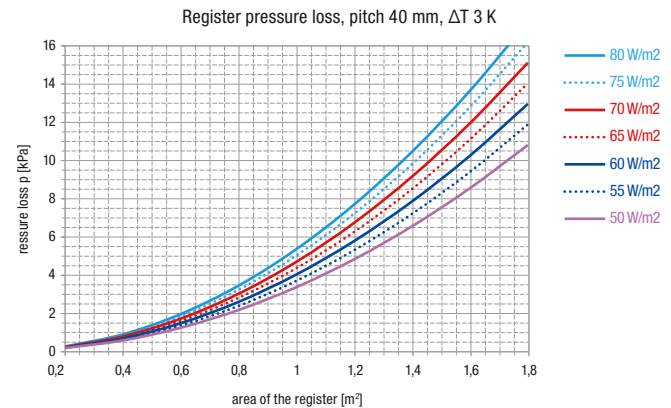

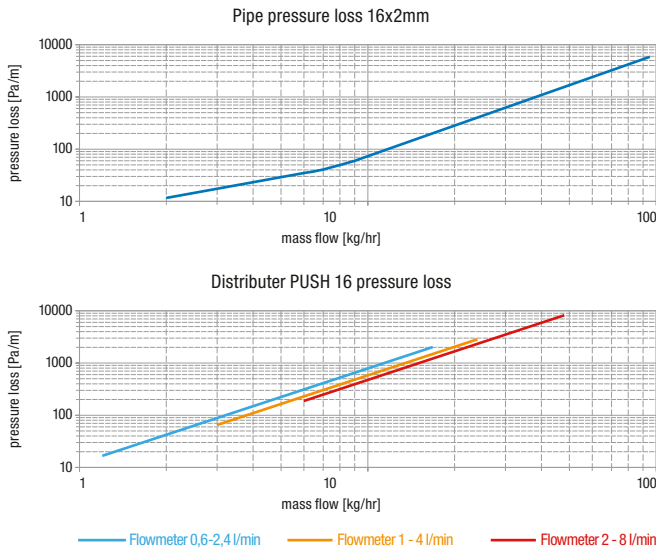

## 5. Regulation

Measuring and regulation devices of brand FV-PLAST contain all the components needed for running of cooling and heating ceilings FV KLIMA. The regulation of ceiling cooling is provided by areal thermostats in combination with condensation point receptors, actuator, converters and central regulation and those either via constant or variable temperature of the cooling medium.

**Constant temperature** of the cooling medium by the ceiling cooling is designed usually to 16 ° C. Room temperature in the room is managed by areal thermostat regulating actuator mounted on the feed valve of the particular cooling sub-circuit.

For **minimizing** of the surface condensation there is installed condensation point receptor in the coolest place in the room (usually at feed duct). Recording the risk of condensation, condensation point receptor will send information to areal thermostat or to converter and those will close particular cooling circuit by use of actuator.

**Variable temperature** of the coolant is provided by regulation on basis of temperature and humidity of the exterior and the interior air. Areal temperature regulation itself run the same way as with systems having constant temperature of the coolant.

### 5.1. Regulation variants

Basically there are two variants of the ceiling cooling system regulation – the simple zone regulation and the central regulation.

#### Simple zone regulation

It is suitable for smaller objects. It is constituted from condensation point receptor, areal thermostat and actuator. Areal thermostat assess room temperature and condensation point receptor signal and it opens or closes manifold valve of the particular circuit with use of actuator.

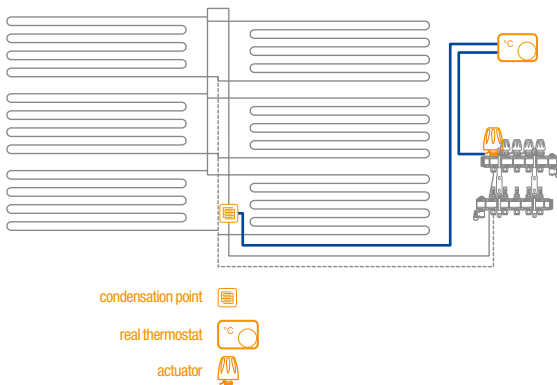

#### Central regulation

It is suitable for bigger objects with higher demands on mutual communication of all domestic systems. Regulation is driven by central regulation unit on basis of the areal temperature and information from the configuration of condensator point receptor and condensation point converter.

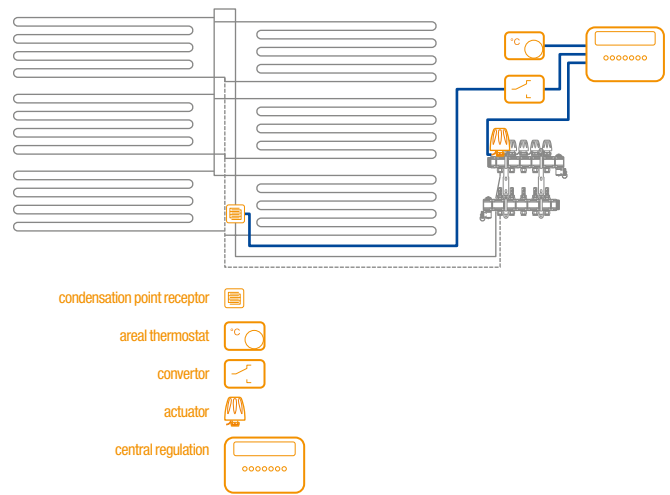

### 5.2. Manual room thermostat

Electronic room thermostat for managing of the areal heating and cooling systems is designated for two-pipes or four-pipes systems. It allows connection up to five condensation point receptors and to protect the cooling system from superficial condensation. Setting of the target temperature is made by adjustment wheel with highlighted range and the actual status is stated by colored indicator.



#### Two-pipes system

Heating and cooling system is used when ceiling cooling is used even in winter time for heating purposes. For initiating the two-pipes mode in the thermostat it is necessary to place jumper unit according to the scheme while installing the system. Thermostat can be then controlled remotely to the target mode of heating/cooling by switch of the contact between clips 3 and 5. In case of the cooling system thermostat opens cooling actuator as the temperature is above the set value. In this mode all the systems and used for heating and cooling are connected to cooling actuator and systems designated only for heating are connected to heating actuator.

#### Four-pipes system

Heating and cooling system is used when ceiling cooling is used only for cooling. For initiating the four-pipes mode in the thermostat it is necessary to keep jumper unit in the default position „cut-off“. Cooling actuator is started if room temperature exceeds set value and heating actuator is started if room temperature drops below set temperature. Between cooling and heating mode there is neutral zone of 2°C, when the system doesn't heat nor cool down.

Example: if thermostat temperature is set to 23°C, heating will be initiated with drop below 21,5°C and it will be shut when reaching 22,5°C. Cooling will be initiated with exceeding of 25 °C and it will be shut with drop below 24°C. In such a case thermostat will keep average room temperature in winter 21,5°C and in summer 24,5°C.

In this mode all the systems used for cooling are connected to cooling actuator and the systems designated for heating and connected to heating actuator.

#### Indication of the thermostat running conditions

- green indicator = zero risk of condensation, system cools down
- yellow indicator = risk of condensation, cooling is interrupted
- red indicator = system heats
- no indicator = system doesn't heat/cool down, room keeps target temperature

## Assembly

- Thermostat is placed to assembly box with diameter 68-75 mm and it is connected according to undermentioned assembly scheme. Placing is selected in such a way so the thermostat won't be affected by sunshine, air flow or stream of hot air from heating – it is placed from 120 to 160 cm high.
- Prior to running commencement there is calibration of thermostat as follows:
  - room temperature is measured with use of room thermometer
  - thermostat range wheel is set to minimal temperature and continuously increased up until the red indicator is out
  - wheel is removed and replaced in such a way so temperature indicator is about 1,5 °C lesser as measured room temperature.

## 5.3. Condensation point convertor

Condensation point convertor FV KLIMA serves as a conversion unit of both the condensation point receptors and the thermal regulation of building within areal cooling systems application. It detects status of condensation point receptors and if there is a risk of condensation it switches output potential-free relay contact by which enables to turn on or off the cooling aggregate, or to close up valve (convertor) of the particular subcircuit. By that it enables to manage temperature of the coolant so there is no condensation emerging. Convertor reacts as relative humidity exceeds 80 % - 85 % and it indicates the status by mounted two-colour indicator. It enables parallel connection of five condensation point receptors.

### Convertor running status indication

- green indicator = no risk of condensation, system is prepared to cool down
- yellow indicator = danger of condensation, cooling is interrupted



## Assembly

Convertor is placed in proximity of the condensation point receptors to installation box. For docking to DIN rail is convertor equipped with docking clipper which is screwed to rear part of the box with use of attached screw. Connection is made according to undermentioned connecting scheme.

## 5.4. Condensation point receptor

Condensation point receptor consists of elastic foil to which is deposited gilt-edged conductive line and cable long 10 m. Receptor is placed to bottom side of the cooling water feed duct having conductive pattern outside and there will be provided contact between receptor surface and cooled room air with use of ventilation grid or plasterboard attachment.

## Assembly

Receptor (1) is placed to bottom side of feed duct having conductive pattern outside and it is fastened with use of attached binding tapes (3 and 4). To prevent receptor tension it is necessary to fasten cable with the tape as first and then add two more tapes on the receptor (4). Within assembly it is necessary to take care while docking the receptor with attached clamps so there won't be damaged receptor's conductive contacts and the clamps are placed outside of active area. Plasterboard attachment (5) is placed across the installed receptor (1) and tapes (6) are fastened in such a way so the attachment panel won't touch the receptor and attachment pipe (5) aimed for middle of the receptor's active area.

If needed the feed can be elongated with the same cable up to 20m. For covering of greater distances it is needed IYSTY 2XO, 6 cable (max. 50 m).

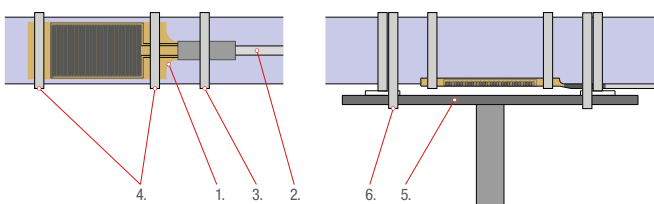

## 5.5. Technical data

device	areal thermostat	convertor
controller	manual wheel	-
supply voltage	24 VAC	24 VAC/DC
working temperature	0 - 50°C	0 - 50°C
regulation range	5 - 30°C	-
safety class	IP 30	IP 20
controller outputs	TRIAC max. 24V/75W	RELÉ max. 230V/6A
actuator amount	max. 5 pcs	max. 10 pcs
receptors amount	max. 5 pcs	max. 5 pcs
installation box size	68 - 75 mm	68-75 mm, or 3 units on the DIN rail

## 5.6. Mounting scheme

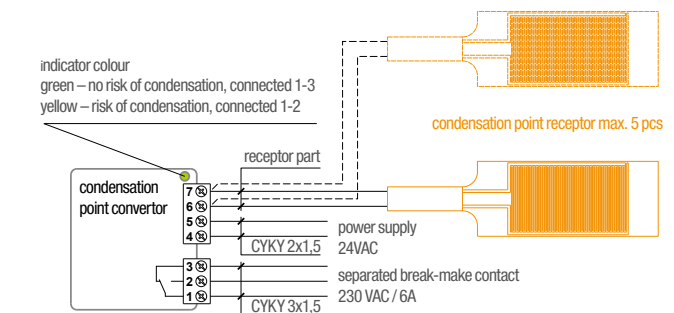

### 2-PIPE SYSTEM – MOUNTING SCHEME

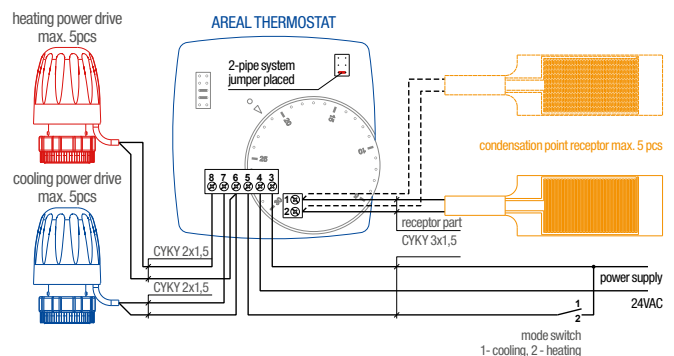

### 4-PIPE SYSTEM – MOUNTING SCHEME

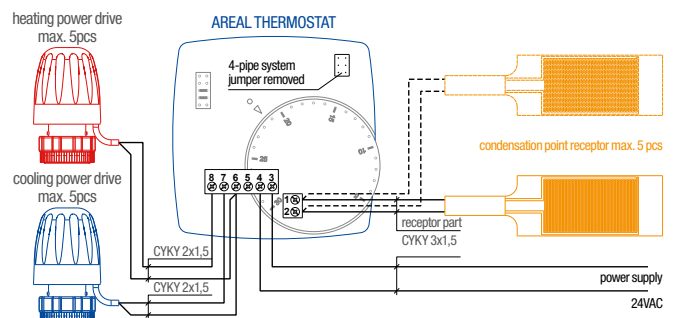

controller colour	heating power drive	cooling power drive	description
red	opened	opened	system is heating
green	closed	opened	system is cooling
yellow	closed	closed	risk of condensation
no colour	closed	closed	target temperature reached

## 6. Assembly process

### 6.1. Fittings

Fittings assembly is made according to following working procedure. Along whole time of handling with fittings it is necessary to take precise care about cleanliness of the fitting and pipe as well, predominantly of their sealing parts.



Pipe is cut by pliers vertically to the duct axis. To prevent pipe flattening it is recommended to rotate pipe in the pliers.



Internal edge of pipe is slightly splayed by manual reamer (art. no. 991137) to depth approx. 1 mm..



Reinforcing sleeve is fully inserted into pipe.



Ending of pipe is covered by silicone paste (art. no. 991120) in range of 15 mm.



Fitting is fully slip over pipe. Pipe 16 is slip over for 27mm, pipe 8 for 20mm. Marks printed on the pipe are designed for orientation.



After the assembly it is possible to rotate contact and after pressing locking circle pipe can be put out. If mounting again pipe needs to be oiled and checked if there is no damage.

### 6.2. Manifold

Manifold is usually placed vertically below the ceiling. Within this way of assembly it is recommended to rotate ending part of manifold by 90° in such a way so deaerating valve would be at the highest possible point and feeding/emptying valve would aim horizontally at bottom. For increasing system reliability with higher flows it is recommended to maintain application principles by Tiechellmann even with manifold and to connect the manifold from one side and the collector from another one.

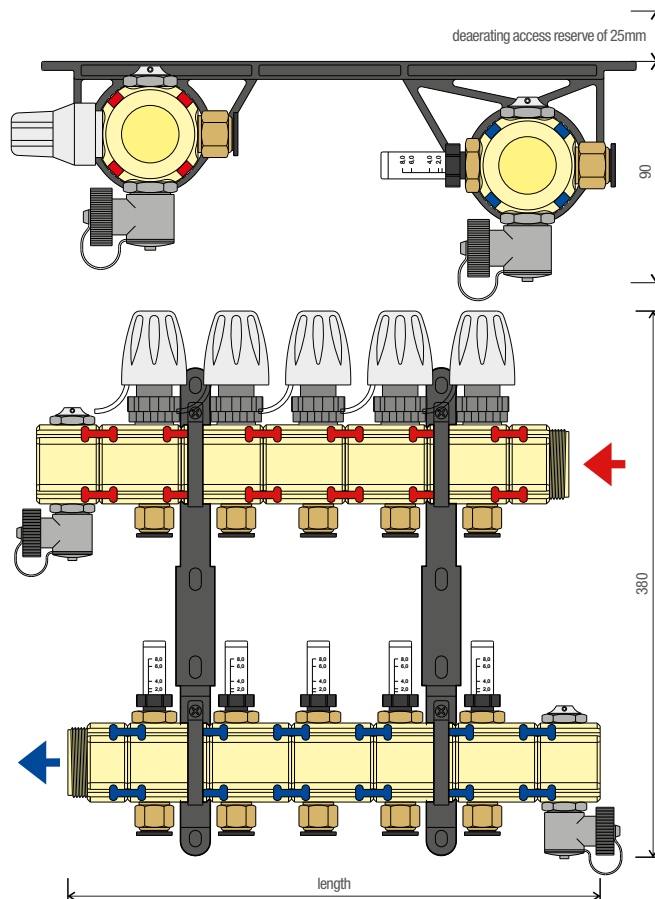

circuits amount	2	3	4	5	6	7	8	9	10	11	12
length in mm	192	247	302	358	414	469	524	580	635	691	746
incl. dist. valve	236	291	346	402	458	513	568	624	679	735	790

### 6.3. Commencement

After assembly and checkout of whole system there is feeding of circuits with clear water according to following procedure:

- all circuits on manifold are closed with use of manual caps and flow meters rotation
- pressure water is supplied to feeding manifold valve and hosepipe is placed to emptying collector valve and conducted away to sewer
- first circuit is opened, water is allowed to flow and once clear air-free stream of water flows the circuit is closed by both valve and flow meter
- another circuit is opened then and so step-by-step is feeded the rest of circuits
- afterwards both distributor units are deaerated having closed valves and flow meters
- all circuits are opened and sealing test is run according to following procedure
- system is pressured to 6 bar, pressure is maintained during 10 minutes and then quickly released
- system is pressured to 2 bar, pressure is maintained during 10 minutes and then quickly released
- system is pressured to 4 bar. Pressure mustn't be decreased under 3,4 bar during 30 minutes and during another 2 hours under 3,2 bar
- during test there mustn't be leakages, test records shall be done
- circuit pumping device is launched and projected flow in all sub-circuits is set by rotating of flow meters
- functional test of regulation is done and the system is prepared for use



## 7. System units

### Pipe FV COOLING PB 8 x 1 mm

#AA960138120

for registers line-up and forming of the active cooling and heating areas. Pipe core from very durable polybutylene is protected from air diffusion by special chemical conditioning EVOH. Pipe surface is covered by polybutylene protective layer.

Pipes length: 600 bm

Maximal safe temperature: 60 °C

Maximal working pressure: 6 bar

Connection capability: plug-in quick couplings and fittings

Colour: blue.



### Collecting main FV COOLING PE-RT 16 x 2 mm

#AA960130110

for distribution of cooling and low-temperature heating. Pipe core from thermally resistant polyethylene is protected from air diffusion by special chemical conditioning EVOH.

Pipe surface is covered by polybutylene protective layer.

Pipes length: 3 lm

Maximal safe temperature: 60 °C

Maximal working pressure: 6 bar

Connection capability: plug-in quick couplings and fittings

Colour: blue.



### Cooling matting CoolFLEX

High quality pipe from polybutylene COOLING PB 8x1 fused-in alluminium foil, which equally delivers first class heat in whole cooling area. It is made in the several variants:

#AA960710000 **perforated matting** - for acoustic metal cassettes and for placing into plastering

#AA960720000 **full matting** - for full metal ceiling cassettes and floor heating

#AA960730000 **full matting for plasterboard** - adapted for fastening on the soffit's steel grid

#AA960740000 **perforated matting for plasterboard** - for cooling of acoustic PBD soffits

Maximal safe temperature: 50 °C

Maximal working pressure: 4 bar



### Cooling matting CoolGRID

High quality polybutylene FV PLAST COOLING pipes 8x1mm are placed in plastic grooves. It is suitable for installation to perforated metal soffits with requirement to improve acoustic features of the room.

Maximal safe temperature: 50 °C

Maximal working pressure: 4 bar



### Plasterboard Thermalpanel FV KLIMA dpt. 10 mm

#AA960130418

with addition of graphite and increased thermal conductivity for covering of the cooling ceilings CoolFLEX

Thickness: 10 mm

Thermal conductivity: 0,45 W/(m.K)

Fire reaction according to ČSN EN 13501 - 1: A2-s1,d0 (B)



### Active plasterboard panel CoolPLATE

#AA960130300

with pipe FV COOLING PB 8 x 1 mm

Cooling pipes PB 8 x 1 are placed in milled grooves of antifire plasterboard having thickness 12,5 mm. Panels contains feeds long 1,2 m and those are connected to central distribution with use of plug-in fittings system.

Circuit length: 28 m (1,25 m<sup>2</sup>)

Maximal safe temperature: 45 °C

Maximal working pressure: 4 bar



### Clamping bar PENTA Ø14/15/16/17/18

#AA960112125

for docking of ceiling cooling distribution from pipe 16x2 mm. Bar is consisted of more separable parts with unlimited length extension option.

Rated length: 1 m, divided by 20 cm

Pitch: 50 mm

For pipes diameter: Ø14 - Ø18 mm



### Arc console R 25 for pipe 8x1

#AA960112127

for fixation of cooling and heating register's arcs with the bar R 25.

For pipes diameter: 0,8 m

Pitch: 25 mm

For pipes diameter: Ø8 mm



**Arc console**

for fixation of cooling and heating register's arcs with the bar R 25  
For pipes diameter: Ø8 mm

#AA960112128

**T-transitional quick coupling Ø16-8-8-16 mm**

it is used for quick plug-in connection of pipes FV COOLING PE-RT 16 x 2 and FV COOLING PB 8 x 1.  
Relieving cases are part of fittings packages.

#AA960134110

**T--transitional quick coupling Ø16-8-8 mm**

it is used for quick plug-in connection of pipes FV COOLING PE-RT 16 x 2 and FV COOLING PB 8 x 1.  
Relieving cases are part of fittings packages.

#AA960134120

**T-transitional quick coupling Ø16-8-16 mm**

it is used for quick plug-in connection of pipes FV COOLING PE-RT 16 x 2 and FV COOLING PB 8 x 1.  
Relieving cases are part of fittings packages.

#AA960134130

**Direct quick coupling Ø8-8 mm**

it is used for quick plug-in connection of pipes FV COOLING PB 8 x 1.  
Relieving cases are part of fittings packages

#AA960134210

**Direct quick coupling Ø16-16 mm**

it is used for quick plug-in connection of pipes FV COOLING PB 8 x 1.  
Relieving cases are part of fittings packages.

#AA960134220

**Angular tube – quick coupling Ø8-8 mm**

it is used for quick plug-in connection of pipes FV COOLING PE-RT 16 x 2.  
Relieving cases are part of fittings packages.

#AA960134310

**Angular tube – quick coupling Ø16-16 mm**

it is used for quick plug-in connection of pipes FV COOLING PE-RT 16 x 2.  
Relieving cases are part of fittings packages.

#AA960134320



### Transition Ø16-½" mm

serves for connecting of pipe FV COOLING PE-RT 16 x 2 to external screw ½".  
Relieving cases are part of fittings packages.

#AA960134510



### Blinder (sealing) unit Ø8 a Ø16 mm

Plug is used for blinding (sealing) of plug-in fittings.

#AA960134610 and #AA960134620



### Reinforcing sleeve Ø8 mm

for reinforcing of pipe in fitting to provide safe connection. Normally it is part of fittings package, must be serapately ordered with separators FV PUSH and as a spare part.

#AA960134710



### Reinforcing sleeve Ø16 mm

for reinforcing of pipe in fitting to provide safe connection. Normally it is part of fittings package, must be separately ordered with separators FV PUSH and as a spare part..

#AA960134720



### PLASTIC SEGMENT MANIFOLD FV PUSH 16

Plastic segment manifold is equipped on the return point with visual adjustable flow meters with range 2 – 8 l/min. (alt. 0.6-2,4 or 1-4l/min.) and on feed point with thermostatic valves with manual covers. Both manifold bodies are equipped with loading and emptying valve, deaerating valve and oxide of iron collecting system.

Required amount of consoles is a part of the package.

Manifold connection: 6/4 " external screw

Circuit connection: pipe 16x2 mm is reinforced with relieving case

#AA960116430

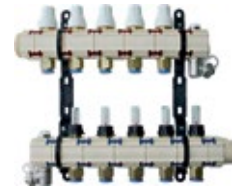

### PLASTIC SEGMENT MANIFOLD FV PUSH 8

Plastic segment manifold is equipped on the return point with visual adjustable flow meters with range 0,6-2,4 l/min and on feed point with thermostatic valves with manual covers. Both manifold bodies are equipped with loading and emptying valve, deaerating valve and oxide of iron collecting system.

Required amount of consoles is a part of the package.

Manifold connection: 6/4 " external screw

Circuit connection: pipe 8x1 mm is reinforced with relieving case

#AA960116250

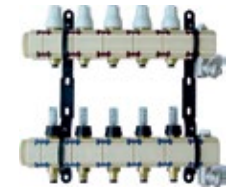

### Spherical valve for dividers FV 6/4"-1"

brassy spherical valve, for dividers FV with outlet nut and sealing,  
Construction lenght: 46 mm.

Connection: internal screw 1", outlet nut 6/4"

#AA960117110



### Manual areal thermostat FV KLIMA

Areal thermostat for regulation of the heating and cooling systems in two-pipe or four-pipe application. It enables direct connection up to 5 condensation point receptors.

Working status indication: coloured indicator

Regulation range: 5-30 ° C

Connection: 24VAC, Ip40, input power 35mA

Cooling output: triac 24V/1A – max. 5 actuators

Heating output: triac 24V/1A – max. 5 actuators

Dimensions (mm): 80x80x31, colour: white

#AA960139315



**Condensation point convertor FV KLIMA**

#AA960139510

It serves as an convertor of the condensation point receptors and thermic regulation of the building within the areal cooling system applications. It detects status of the condensation point receptors and in case of the condensation risk it switches output potential-free relay contact. It enables parallel connection up to 5 condensation point receptors.

Working voltage: 24 VAC, IP20, current consumption 40mA.

Potential-free switch contact: 6 (2) A/230VAC

**Condensation point receptor**

#AA960139410

It records eventual risk of condensation and informs areal thermostat or condensation point convertor.

Cable length: 10 m

Placing: on feed pipe from distributor, in contact with internal area of room

**Condensation point receptor for plasterboard ceiling**

#AA960139420

It records eventual risk of condensation and informs areal thermostat or condensation point convertor. It is equipped with buffering pipe for assembly to light soffit constructions.

Cable length: 10 m

Pipe length: 400 mm

Placing: on feed pipe from distributor, in contact with internal area of room

**Actuator 24 V NC**

#AA960139120

It provides regulation of the FV PUSH individual manifold valves.

Variant: NC (closed when current-free)

Cover: IP65

Distribution: height 70mm, diameter approximately 45 mm, cable length 1 m.

Input power: 2 W / 24 VAC

Connection: outlet nut M30x1,5

**Actuator 24 V NO**

#AA960139130

It provides regulation of the FV PUSH individual manifold valves.

Variant: NO (opened when current-free)

Cover: IP40

Distribution: height 70mm, diameter approximately 45 mm, cable length 1 m.

Input power: 3 W / 24 VAC

Connection: outlet nut M30x1,5

**Safety transformer 230/24 V**

#AA960139210

Safety transformer for regulation systems transforms voltage from 230 V to 24 V.

Charging: 60 W

**Bus UZR 24 - 4**

#AA960276441

4 channel module of the zone regulation. It is basic construction element of the zone regulation. It processes directions from areal thermostats and controls individual heating circuits with use of actuators.

It contains power supply, connection of actuator units and thermostats, statuses indicator and pumping device module.

Working voltage 24 VAC, gray colour

**Extending bus module URM 24 - 2**

#AA960276443

2 channel extending module of the zone regulation UZR 24-4 for actuators having 24V.

Working voltage 24VAC, gray colour

**FV KLIMA silicone paste for sealing O-circlets**

#AA960991120

It is deposited prior to plugging in of the connecting screwing to pipe or anywhere else, where are used sealing o-circlets. Greasing substance prevents eventual mechanic damage of sealing while mounting.



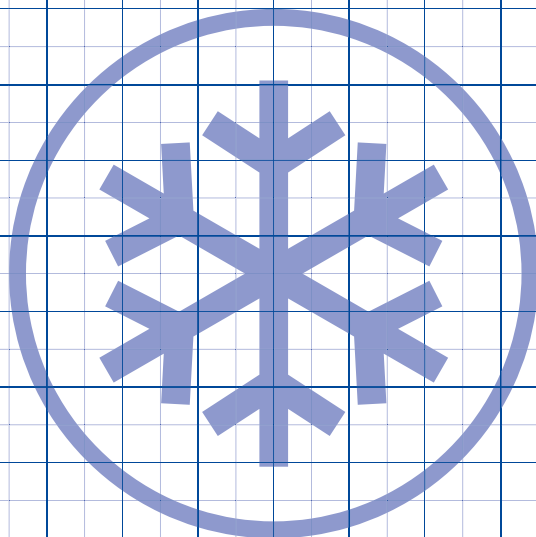

## 8. References



Head office ČEZ Hradec Králové CZ, 2006 - CoolPLATE



University Frankfurt am Main Germany, 2017 - CoolFLEX



Luxury apartment building Belgrade Serbia, 2015 - CoolGRID



Office building QUBIX Prague CZ, 2010 - CoolGRID



Training center Lovosice CZ, 2016 - CoolPLATE, CoolGRID



Head office Komwag Prague CZ, 2015 - CoolGRID



Historical building, offices Prague CZ, 2015 - CoolGRID



Head office ES Chotikov CZ, 2017 - CoolFLEX, CoolGRID

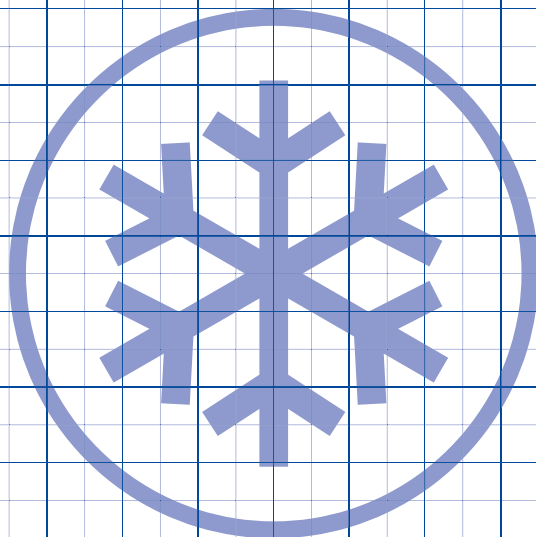



**FV - Plast, a.s.**

Kozovazská 1049/3	T: +420 326 706 711
250 88 Čelákovice	F: +420 326 706 721
Czech Republic	@: fvplast@fvplast.com

**WWW.FVPLAST.COM**