



... more than pipes



FV THERM



FV ENERGEO



FV AQUA



FV INFRA

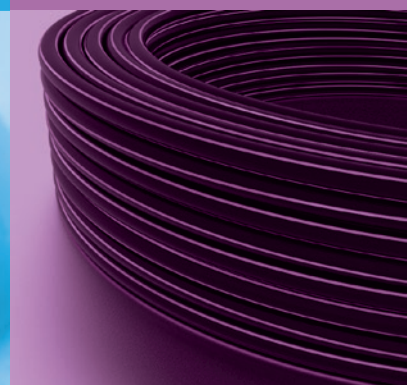

WWW.FV-PLAST.CZ



Dear business friends,

we are pleased to introduce a new portfolio of products of the company FV - Plast, a.s.

Our company celebrated 25 years since its founding – and this anniversary caught us in a good form. In the course of past years, our company achieved a significant growth in sales. We managed to consolidate our strong position on the Czech market and strengthen it significantly abroad, where 70 % of our production is directed. It affirms the rightness of our philosophy, focused on systemic and innovative solutions, quality, helpful customer service and building long-term partnerships with our foreign distributors.

FV - Plast, a.s. has always built on reliability which is crucial both for implementation companies and end customers. As a matter of principle, our company therefore includes in its portfolio only the technologies that have proven to be effective in practice. Reliability is closely connected to the emphasis which we place on quality. We buy Input raw materials strictly from renowned European suppliers and we constantly supervise our products in our own laboratory, in which we have invested more than 1.5 mil EUR.

The portfolio of FV - Plast, a.s. can be divided into four systemic groups:

- FV AQUA a system for complete water and heating distribution solutions in residential industrial development
- FV THERM a system for underfloor heating
- FV ENERGEO a systemic solution for a primary section of geothermal heat sources
- FV INFRA piping for infrastructure distributions

Products of the company FV - Plast, a.s. are certified in EU and in a whole range of other countries, such as Russia, SAE.

We are looking forward to our cooperation!

EXPLANATORY NOTES FOR GRAPHICAL SYMBOLS

Dimension	Unit	Amount in a large package	Amount in a small package	kg/unit	dm³/unit

Potable water	Heating, Cooling	Pools	Chemical industry	Marine architecture	Infrastructure	Industrial cooling	Service water	Geothermics

# ●		Gray
# ●		Green
# ●		White

Print errors are reserved.

CONTENTS

FV AQUA

Pipes for polyfusion welding	14
Plastic Fittings.....	22
Combination Fittings.....	30
Closing Fittings	38
FV PP-RCT fittings for but welding.....	42
Tools suitable for FV AQUA PPR	48
Assembly instructions	57
FV MULTIPIPES	64
FV M-PRESS brass press fittings.....	66
FV P-PRESS plastic press fittings.....	74
Tools and accessories for FV MULTI.....	78
Assembly instructions for connecting of pipes with FV M-PRESS and FV P-PRESS.....	80
Accessories	82

FV THERM

System pipes for heating	90
System plates	91
Manifold	94
Mixing sets	95
Valves and thermometers	95
Boxes.....	96
Accessories	96
Control	98
Joins	99
Accessories	100
Assembly instructions.....	102

FV ENERGEO

Manifold Shafts.....	108
Manifold boxes.....	110
Manifold plain.....	110
Accessories to Distributor Wells	111
Fittings	111
Probes	113
Pipes for horizontal collector.....	115
Tools	116
Instructions for laying ground probes and collectors	117

FV INFRA

FV INFRA pipes.....	120
Layout and connection assembly instructions.....	122
Index.....	124

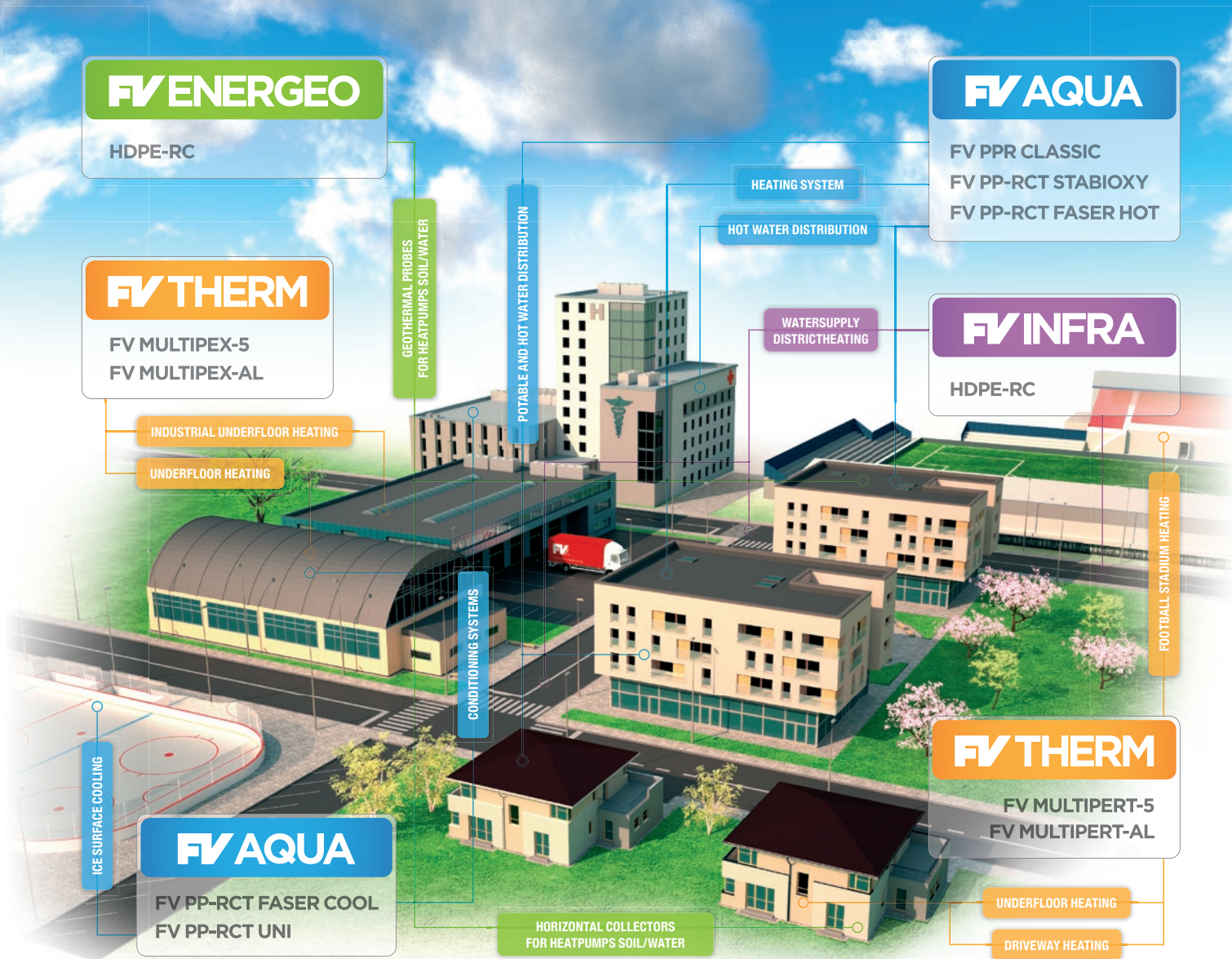

FV PLAST: MORE THAN PIPES

USE OF FV ELEMENTS

		Potable water	Air conditioning, cooling water	Hot water	Underfloor heating	Low temperature heating	High temperature heating	Preasurized air	Probes and horizontal collectors	Watersupply and connections
FV AQUA	FV PPR CLASSIC S2,5 SDR6 (PN 20)		●	●	●	●		●		
	FV PPR CLASSIC S3,2 SDR7 (PN 16)	●		●		●		●		
	FV PPR FASER S2,5 SDR6 (PN 20)	●		●		●	●	●		
	FV PP-RCT UNI	●●	●	●	●	●		●		
	FV PP-RCT HOT	●		●●	●	●		●		
	FV PP-RCT FASER COOL	●	●●	●				●		
	FV PP-RCT FASER HOT			●●	●●	●●	●	●		
	FV PP-RCT STABIOXY			●	●	●	●●			
	FV MULTIPERT-AL	●	●	●	●	●	●			
	FV MULTIPEX-AL	●	●	●	●	●	●●			
	Fittings FV PPR	●●	●●	●●		●●	●●	●		
	Fittings FV P-PRESS	●●	●●	●●	●●	●●	●			
	Fittings FV M-PRESS	●	●	●●	●●	●●	●●			
FV THERM	FV MULTIPERT-5	●	●	●	●	●	●●			
	FV MULTIPEX-5	●	●	●	●	●	●			
	FV MULTIPERT-AL	●	●	●	●	●	●			
	FV MULTIPEX-AL	●	●	●	●	●	●●			
FV ENERGEO	FV ENERGEO GH								●●	
	FV ENERGEO CP								●●	
FV INFRA	FV HDPE									●
	FV HDPE RC									●

Explanations: ● Suitable application area
●● Priority application area

NEW

FV PP-RCT

A NEW GENERATION OF DISTRIBUTIONS

A new generation of FV PP-RCT pipes utilizes superb properties of the PP-RCT material in smooth wall and multi-layer pipes. Compared to the PPR pipes, the PP-RCT material enables to achieve the same or better pressure and thermal endurance with lesser thickness.

ADVANTAGES:

- a flow cross-section is higher by 20 % compared to PPR pipes
- a proven way of connecting by polyfusion welding as in the case of PPR
- a higher range of working temperatures for a given application "HOT" or "COOL"
- a third as high thermal expansivity as in the case of PPR pipes (in the case of PP-RCT FASER and STABIOXY)
- a lifespan of more than 50 years

FV PP-RCT pipes come in 5 modifications according to the purpose:

- **FV PP-RCT HOT**
Suitable for hot water distributions.
For applications between 20°C/2,0MPa - 70°C/1,0MPa
- **FV PP-RCT FASER HOT** with glass fibers
Suitable for hot water and heating distributions.
For applications between 20°C/2,0MPa-70°C/1,0MPa with maximum diameter of D=125 and 20°C/1,6MPa-70°C/0,8MPa for diameters D=160 and higher
- **FV PP-RCT STABIOXY** with a compact Al-oxygen barrier.
Suitable for high-temperature heating distributions
For applications up to 70°C/1,0MPa - 90°C/0,8MPa
- **FV PP-RCT UNI**
A universal piping for water and air distributions.
For applications up to 20°C/1,6MPa-60°C/0,8MPa
- **FV PP-RCT FASER COOL** with glass fibers.
Suitable for cold water and air distributions.
20°C/1,6 MPa-70°C/0,8MPa with maximum diameter of D=125 and 20°C/1,0MPa-70°C/0,5MPa for diameters D=160 and higher.



... more than pipes

WWW.FV-PLAST.CZ

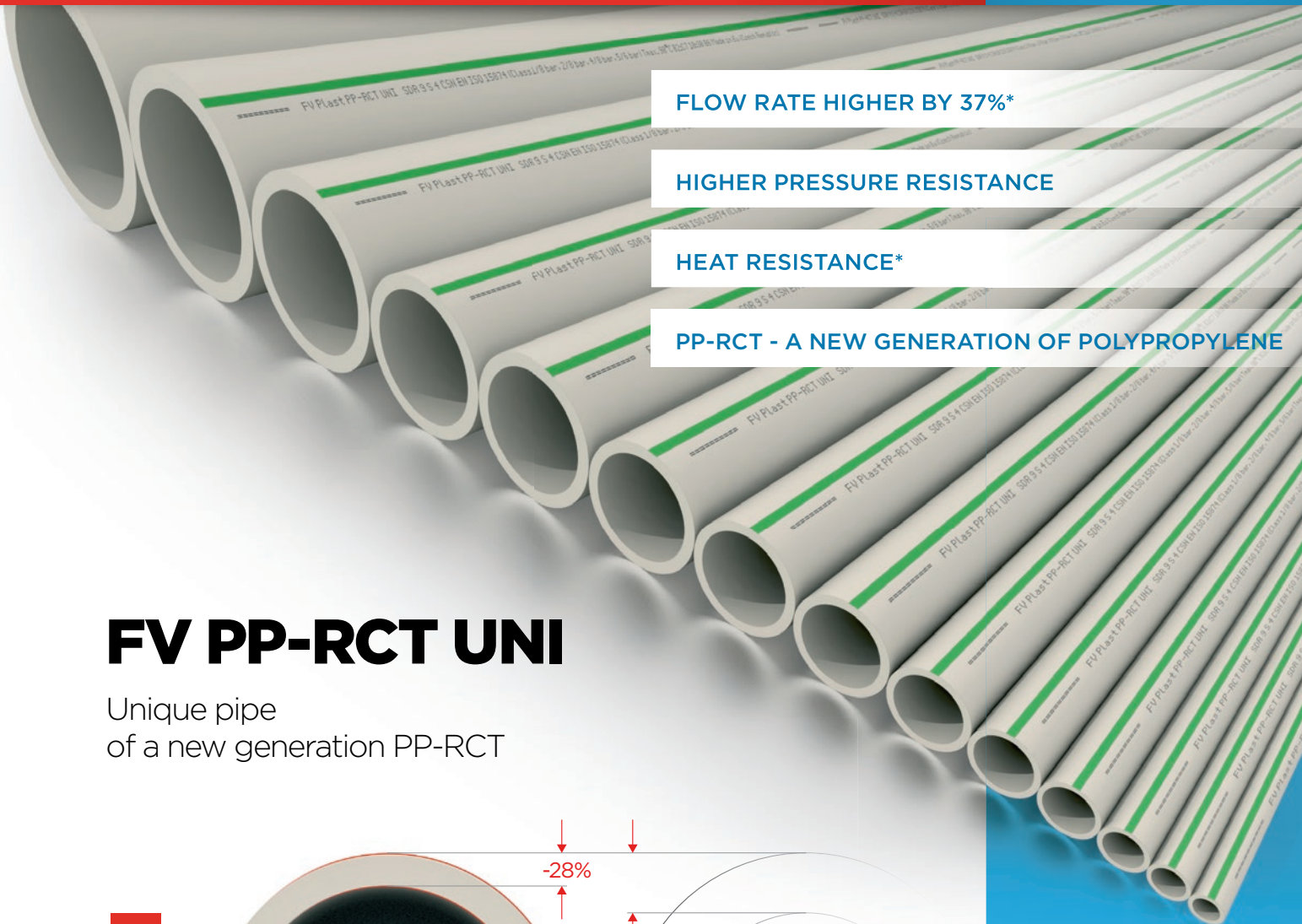

FLOW RATE HIGHER BY 37%*

HIGHER PRESSURE RESISTANCE

HEAT RESISTANCE*

PP-RCT - A NEW GENERATION OF POLYPROPYLENE

FV PP-RCT UNI

Unique pipe
of a new generation PP-RCT

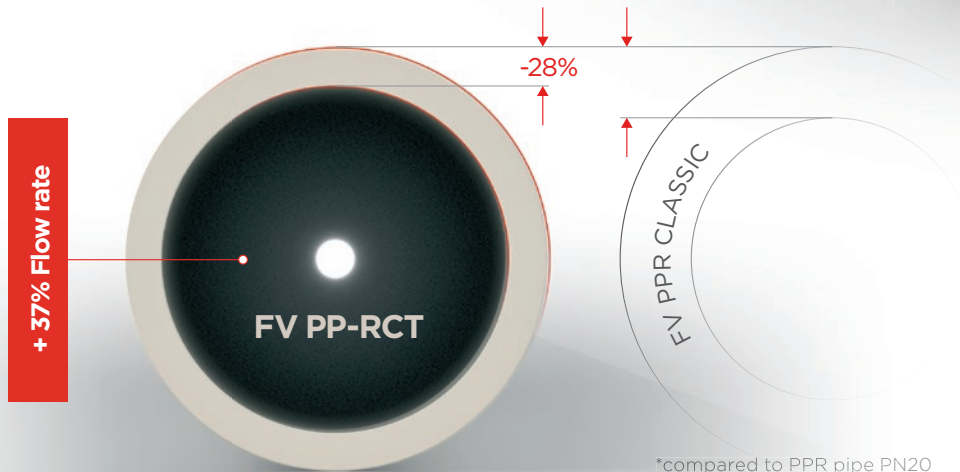

*compared to PPR pipe PN20

FV AQUA

NEW

FV ENERGEO

A SYSTEM FOR UTILIZATION OF GEOTHERMAL ENERGY

FV ENERGEO is a compact system of components for solutions of primary circuits of heat pumps utilizing geothermal energy.

FV ENERGEO = ALL KEY COMPONENTS UNDER A SINGLE BRAND:

- Geothermal probes and horizontal collectors
- All components of highly resilient HDPE 100 RC
- Manifolds shafts and cases from 2 to 30 circuits
- Connecting components

The whole FV ENERGEO system is designed in such a way that it is reliable under extreme conditions. The elements are resistant to high pressure, freeze and corrosion. All the components are manufactured solely from high-quality materials under constant supervision and are tested beyond the nor.

Advantages of obtaining geothermal energy with FV ENERGEO:

- High quality and long lifespan of the components
- Reliability of the probes and collectors guaranteed thanks to the long-time experience in the field of pressure distributions
- Technical consulting for special solutions
- All the components are quickly available





FV ENERGEO CP HDPE 100 RC

HDPE-RC pipe for construction
of horizontal collectors of heat pumps

LIFE OF MORE THAN 100 YEARS

BACKFILL WITH EXCAVATED MATERIAL WITH GRAIN UP TO 250 mm

COILS UP TO 300 m



FV
PLAST®





PIPES FOR POLYFUSION WELDING

FV PP-RCT UNI

System: **FV AQUA**
 Material: PP-RCT
 Standard: ČSN EN ISO 15874, DIN 8077, DIN 8078
 Details: Suitable for water distribution to 60°C
 and compressed air For application in systems
 to 20°C/1,6MPa - 60°C/0,8MPa.

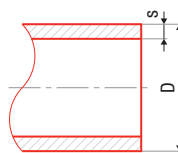

Ø _{ext}	⊕	⊞	⊞	⊞	dm ²	# ●	# ●	# ●	D [mm]	s [mm]	SDR	l [m]	
16 × 2,2	m	160			0,095	0,28	AA110016004	BA110016004		16	2,2	7,4	4
20 × 2,3	m	100			0,127	0,44	AA110020004	BA110020004		20	2,3	9	4
25 × 2,8	m	60			0,191	0,73	AA110025004	BA110025004		25	2,8	9	4
32 × 2,9	m	40			0,261	1,10	AA110032004	BA110032004		32	2,9	11	4
40 × 3,7	m	24			0,412	1,83	AA110040004	BA110040004		40	3,7	11	4
50 × 4,6	m	16			0,638	2,75	AA110050004	BA110050004		50	4,6	11	4
63 × 5,8	m	12			1,010	4,07	AA110063004	BA110063004		63	5,8	11	4
75 × 6,8	m	8			1,410	5,50	AA110075004	BA110075004		75	6,8	11	4
90 × 8,2	m	4			2,030	9,17	AA110090004	BA110090004		90	8,2	11	4
110 × 10	m	4			3,010	10,31	AA110110004	BA110110004		110	10,0	11	4
125 × 11,4	m	4			3,910	12,27		BA110125004		125	11,4	11	4
160 × 14,6	m	4			6,380	20,10		BA110160004		160	14,6	11	4
200 × 18,2	m	4			9,950	31,40		BA110200004		200	18,2	11	4
250 × 22,7	m	4			15,500	49,06		BA110250004		250	22,7	11	4

FV PP-RCT FASER COOL

System: **FV AQUA**
 Material: PP-RCT/PP-RCT+GF/PP-RCT
 Standard: ČSN EN ISO 15874, DIN 8077, DIN 8078,
 DIN 16962, DIN EN ISO 15874
 Details: Suitable for cold water distribution and compressed
 air for application in systems 20°C/1,6MPa - 70°C/0,8 MPa
 to D=125 and 20°C/1,0MPa - 70°C/0,5MPa to D=160 even larger.

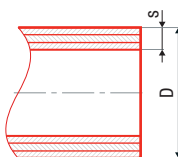

Ø _{ext}	⊕	⊞	⊞	⊞	dm ²	# ●	# ●	# ●	D [mm]	s [mm]	SDR	l [m]	
40 × 3,7	m	24			0,439	1,83	AA111040004	BA111040004		40	3,7	11	4
50 × 4,6	m	16			0,678	2,75	AA111050004	BA111050004		50	4,6	11	4
63 × 5,8	m	12			0,996	4,07	AA111063004	BA111063004		63	5,8	11	4
75 × 6,8	m	8			1,419	5,50	AA111075004	BA111075004		75	6,8	11	4
90 × 8,2	m	4			2,039	9,17	AA111090004	BA111090004		90	8,2	11	4
110 × 10,0	m	4			3,031	10,31	AA111110004	BA111110004		110	10,0	11	4
125 × 11,4	m	4			3,760	12,27		BA111125004		125	11,4	11	4
160 × 9,5	m	4			4,635	20,10		BA111160004		160	9,5	17	4
200 × 11,9	m	4			7,321	31,40		BA111200004		200	11,9	17	4
250 × 14,8	m	4			11,065	49,06		BA111250004		250	14,8	17	4
125 × 11,4	m	6			3,430	12,27		BA111125006		125	11,4	11	6
160 × 9,5	m	6			4,760	20,10		BA111160006		160	9,5	17	6
200 × 11,9	m	6			7,321	31,40		BA111200006		200	11,9	17	6
250 × 14,8	m	6			11,065	49,06		BA111250006		250	14,8	17	6

FV PP-RCT HOT

System: **FV AQUA**
 Material: PP-RCT
 Standard: ČSN EN ISO 15874, DIN 8077, DIN 8078
 Details: Suitable for hot water distribution. For application in systems 20°C/2,0MPa - 70°C/1,0MPa.

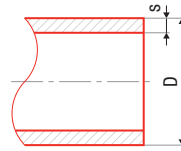

□ ₁₁₁	⊕	⊞	⊞	⊞	⊞	# ●	# ●	# ●	D [mm]	s [mm]	SDR	l [m]
20 x 2,8	m	100			0,148	0,44	AA112020004	BA112020004	20	2,8	7,4	4
25 x 3,5	m	60			0,230	0,73	AA112025004	BA112025004	25	3,5	7,4	4
32 x 4,4	m	40			0,370	1,10	AA112032004	BA112032004	32	4,4	7,4	4
40 x 5,5	m	24			0,575	1,83	AA112040004	BA112040004	40	5,5	7,4	4
50 x 6,9	m	16			0,896	2,75	AA112050004	BA112050004	50	6,9	7,4	4
63 x 8,6	m	12			1,410	4,07	AA112063004	BA112063004	63	8,6	7,4	4
75 x 10,3	m	8			2,010	5,50	AA112075004	BA112075004	75	10,3	7,4	4
90 x 12,3	m	4			2,870	9,17	AA112090004	BA112090004	90	12,3	7,4	4
110 x 15,1	m	4			4,300	10,31	AA112110004	BA112110004	110	15,1	7,4	4
125 x 17,1	m	4			5,530	12,27		BA112125004	125	17,1	7,4	4

FV PP-RCT FASER HOT

System: **FV AQUA**
 Material: PP-RCT/PP-RCT+GF/PP-RCT
 Standard: ČSN EN ISO 15874, DIN 8077, DIN 8078, DIN 16962, DIN EN ISO 15874

Details: Suitable for hot water distribution. For application in systems 20°C/2,0MPa - 70°C/1,0MPa to D=125 and 20°C/1,6MPa - 70°C/0,8MPa to D=160 even larger.

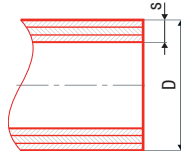

□ ₁₁₁	⊕	⊞	⊞	⊞	⊞	# ●	# ●	# ●	D [mm]	s [mm]	SDR	l [m]
20 x 2,8	m	100			0,151	0,44	AA113020004	BA113020004	20	2,8	7,4	4
25 x 3,5	m	60			0,232	0,73	AA113025004	BA113025004	25	3,5	7,4	4
32 x 3,6	m	40			0,340	1,10	AA113032004	BA113032004	32	3,6	9	4
40 x 4,5	m	24			0,513	1,83	AA113040004	BA113040004	40	4,5	9	4
50 x 5,6	m	16			0,746	2,75	AA113050004	BA113050004	50	5,6	9	4
63 x 7,1	m	12			1,190	4,07	AA113063004	BA113063004	63	7,1	9	4
75 x 8,4	m	8			1,700	5,50	AA113075004	BA113075004	75	8,4	9	4
90 x 10,1	m	4			2,400	9,17	AA113090004	BA113090004	90	10,1	9	4
110 x 12,3	m	4			3,400	10,31	AA113110004	BA113110004	110	12,3	9	4
125 x 14,0	m	4			4,480	12,27		BA113125004	125	14	9	4
160 x 14,6	m	4			6,775	20,10		BA113125004	160	14,6	11	4
200 x 18,2	m	4			10,640	31,40		BA113160004	200	18,2	11	4
250 x 22,7	m	4			16,610	49,06		BA113160004	250	22,7	11	4
125 x 14,0	m	6			4,480	12,27		BA113200006	125	14,0	9	6
160 x 14,6	m	6			6,775	20,10		BA113200006	160	14,6	11	6
200 x 18,2	m	6			10,640	31,40		BA113250006	200	18,2	11	6
250 x 22,7	m	6			16,610	49,06		BA113250006	250	22,7	11	6

FV PP-RCT STABIOXY

System: **FV AQUA**
 Material: PP-RCT/Al/PP-R
 Standard: ČSN EN ISO 21003, DIN 4726
 Details: Suitable for radiator heating. For application in systems 70°C/1,0MPa - 90°C/0,8MPa.

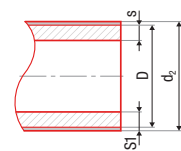

□ ₁₁₁	⊕	⊞	⊞	⊞	⊞	# ●	# ●	# ●	D [mm]	d ₂ [mm]	s [mm]	SDR	l [m]
20 x 2,8	m	100			0,21	0,44	AA114020004	BA114020004	20	22,2	2,8	7,4	4
25 x 2,8	m	60			0,31	0,73	AA114025004	BA114025004	25	27,2	2,8	9	4
32 x 3,6	m	40			0,47	1,10	AA114032004	BA114032004	32	34,2	3,6	9	4
40 x 4,5	m	24			0,69	1,83	AA114040004	BA114040004	40	42,2	4,5	9	4
50 x 5,6	m	16			1,04	2,75	AA114050004	BA114050004	50	52,3	5,6	9	4
63 x 7,1	m	12			1,57	4,07	AA114063004	BA114063004	63	65,4	7,1	9	4
75 x 8,4	m	8			2,25	5,50	AA114075004	BA114075004	75	77,5	8,4	9	4
90 x 10,1	m	4			3,37	9,17	AA114090004	BA114090004	90	93	10,1	9	4
110 x 12,3	m	4			5,00	10,31	AA114110004	BA114110004	110	113,6	12,3	9	4

FV PPR CLASSIC S2,5 SDR6 (PN 20) 4m

System: **FV AQUA**

Material: PPR

Standard: ČSN EN ISO 15874, DIN 8077, DIN 8078

Details: A 4-m pipe from among the highest pressure range, suitable for hot water distribution systems, applications in high-rise buildings, apartment and panel buildings.

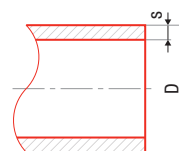

Icon	Icon	Icon	Icon	Icon	dm ²	# ●	# ●	# ●	D [mm]	s [mm]	l [m]
16 x 2,7	m	160		0,11	0,28	AA101016004	BA101016004	WA101016004	16	2,70	4
20 x 3,4	m	100		0,17	0,44	AA101020004	BA101020004	WA101020004	20	3,40	4
25 x 4,2	m	60		0,27	0,73	AA101025004	BA101025004	WA101025004	25	4,20	4
32 x 5,4	m	40		0,43	1,10	AA101032004	BA101032004	WA101032004	32	5,40	4
40 x 6,7	m	24		0,67	1,83	AA101040004	BA101040004	WA101040004	40	6,70	4
50 x 8,3	m	16		1,00	2,75	AA101050004	BA101050004	WA101050004	50	8,30	4
63 x 10,5	m	12		1,65	4,07	AA101063004	BA101063004	WA101063004	63	10,50	4
75 x 12,5	m	8		2,34	5,50	AA101075004	BA101075004	WA101075004	75	12,50	4
90 x 15	m	4		3,36	9,17	AA101090004	BA101090004	WA101090004	90	15,00	4
110 x 18,3	m	4		5,01	10,31	AA101110004	BA101110004	WA101110004	110	18,30	4

FV PPR CLASSIC S2,5 SDR6 (PN 20) 3m

System: **FV AQUA**

Material: PPR

Standard: ČSN EN ISO 15874, DIN 8077, DIN 8078

Details: A 3-m pipe from among the highest pressure range, suitable for hot water distribution systems, applications in high-rise buildings, apartment and panel buildings.

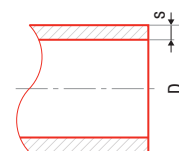

Icon	Icon	Icon	Icon	Icon	dm ²	# ●	# ●	# ●	D [mm]	s [mm]	l [m]
16 x 2,7	m	120		0,11	0,28	AA101016003	BA101016003	WA101016003	16	2,70	3
20 x 3,4	m	75		0,17	0,44	AA101020003	BA101020003	WA101020003	20	3,40	3
25 x 4,2	m	45		0,27	0,73	AA101025003	BA101025003	WA101025003	25	4,20	3
32 x 5,4	m	30		0,43	1,10	AA101032003	BA101032003	WA101032003	32	5,40	3
40 x 6,7	m	18		0,67	1,83	AA101040003	BA101040003	WA101040003	40	6,70	3
50 x 8,3	m	12		1,00	2,75	AA101050003	BA101050003	WA101050003	50	8,30	3
63 x 10,5	m	9		1,65	4,07	AA101063003	BA101063003	WA101063003	63	10,50	3

FV PPR CLASSIC S3,2 SDR7,4 (PN 16) 4m

System: **FV AQUA**

Material: PPR

Standard: ČSN EN ISO 15874, DIN 8077, DIN 8078

Details: A universal, most often used 4-m pipe for distribution systems for drinking, cold and hot industrial water of up to 60°C in family houses and apartment buildings.

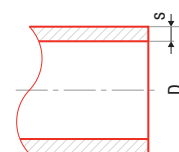

Icon	Icon	Icon	Icon	Icon	dm ²	# ●	# ●	# ●	D [mm]	s [mm]	l [m]
16 x 2,2	m	160		0,10	0,28	AA102016004	BA102016004	WA102016004	16	2,20	4
20 x 2,8	m	100		0,15	0,44	AA102020004	BA102020004	WA102020004	20	2,80	4
25 x 3,5	m	60		0,23	0,73	AA102025004	BA102025004	WA102025004	25	3,50	4
32 x 4,4	m	40		0,37	1,10	AA102032004	BA102032004	WA102032004	32	4,40	4
40 x 5,5	m	24		0,58	1,83	AA102040004	BA102040004	WA102040004	40	5,50	4
50 x 6,9	m	16		0,90	2,75	AA102050004	BA102050004	WA102050004	50	6,90	4
63 x 8,6	m	12		1,41	4,07	AA102063004	BA102063004	WA102063004	63	8,60	4
75 x 10,3	m	8		2,00	5,50	AA102075004	BA102075004	WA102075004	75	10,30	4
90 x 12,3	m	4		2,90	9,17	AA102090004	BA102090004	WA102090004	90	12,30	4
110 x 15,1	m	4		4,30	10,31	AA102110004	BA102110004	WA102110004	110	15,10	4

FV PPR CLASSIC S3,2 SDR7,4 (PN 16) 3m

System: **FV AQUA**

Material: PPR

Standard: ČSN EN ISO 15874, DIN 8077, DIN 8078

Details: A universal, most often used 3-m pipe for distribution systems for drinking, cold and hot industrial water of up to 60°C in family houses and apartment buildings.

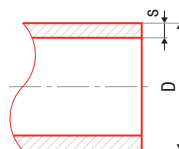

Icon	⊕	⊞	⊞	⊞	⊞	# ●	# ●	# ●	D [mm]	s [mm]	l [m]	
	m	75			0,15	0,44	AA102020003	BA102020003	WA102020003	20	2,80	3
	m	45			0,23	0,73	AA102025003	BA102025003	WA102025003	25	3,50	3
	m	30			0,37	1,10	AA102032003	BA102032003	WA102032003	32	4,40	3
	m	18			0,58	1,83	AA102040003	BA102040003	WA102040003	40	5,50	3
	m	12			0,90	2,75	AA102050003	BA102050003	WA102050003	50	6,90	3
	m	9			1,41	4,07	AA102063003	BA102063003	WA102063003	63	8,60	3

FV PPR CLASSIC - PIPE IN COIL

System: **FV AQUA**

Material: PPR

Standard: ČSN EN ISO 15874, DIN 8077, DIN 8078

Details: A pipe packed in 200-m rolls suitable for floor heating systems.

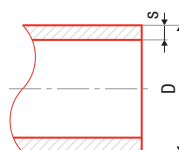

Icon	⊕	⊞	⊞	⊞	⊞	# ●	# ●	# ●	D [mm]	s [mm]	l [m]	
	m	200			0,09	2,01	AA103016200	BA103016200	WA103016200	16	2,00	200
	m	200			0,11	3,14	AA103020200	BA103020200	WA103020200	20	2,00	200
	m	200			0,15	3,14	AA102020200	BA102020200	WA102020200	20	2,80	200
	m	200			0,17	3,14	AA101020200	BA101020200	WA101020200	20	3,40	200

FV PPR FASER S2,5 SDR6 (PN 20) 4m

System: **FV AQUA**
 Material: PP-R/PP-R+GF/PP-R
 Standard: DIN 16962, DIN EN ISO 15874
 Details: A universal 4-m pipe for the most challenging drinking, hot and heating water distribution systems.

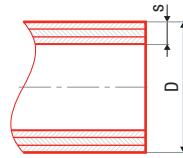

DN	mm	mm	mm	mm	mm ²	# ●	# ●	# ●	D [mm]	s [mm]	l [m]
20 × 3,4	m	100		0,19	0,44	AA107020004	BA107020004	WA107020004	20	3,40	4
25 × 4,2	m	60		0,28	0,73	AA107025004	BA107025004	WA107025004	25	4,20	4
32 × 5,4	m	40		0,45	1,10	AA107032004	BA107032004	WA107032004	32	5,40	4
40 × 6,7	m	24		0,69	1,83	AA107040004	BA107040004	WA107040004	40	6,70	4
50 × 8,3	m	16		1,07	2,75	AA107050004	BA107050004	WA107050004	50	8,30	4
63 × 10,5	m	12		1,74	4,07	AA107063004	BA107063004	WA107063004	63	10,50	4
75 × 12,5	m	8		2,41	5,50	AA107075004	BA107075004	WA107075004	75	12,50	4
90 × 15,0	m	4		3,47	9,17	AA107090004	BA107090004	WA107090004	90	15,00	4
110 × 18,3	m	4		5,17	10,31	AA107110004	BA107110004	WA107110004	110	18,30	4

FV PPR FASER S2,5 SDR6 (PN 20) 3m

System: **FV AQUA**
 Material: PP-R/PP-R+GF/PP-R
 Standard: DIN 16962, DIN EN ISO 15874
 Details: A universal 3-m pipe for the most challenging drinking, hot and heating water distribution systems.

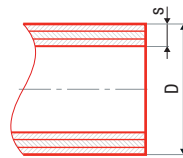

DN	mm	mm	mm	mm	mm ²	# ●	# ●	# ●	D [mm]	s [mm]	l [m]
20 × 3,4	m	75		0,19	0,44	AA107020003	BA107020003	WA107020003	20	3,40	3
25 × 4,2	m	45		0,28	0,73	AA107025003	BA107025003	WA107025003	25	4,20	3
32 × 5,4	m	30		0,45	1,10	AA107032003	BA107032003	WA107032003	32	5,40	3
40 × 6,7	m	18		0,69	1,83	AA107040003	BA107040003	WA107040003	40	6,70	3
50 × 8,3	m	12		1,07	2,75	AA107050003	BA107050003	WA107050003	50	8,30	3
63 × 10,5	m	9		1,74	4,07	AA107063003	BA107063003	WA107063003	63	10,50	3

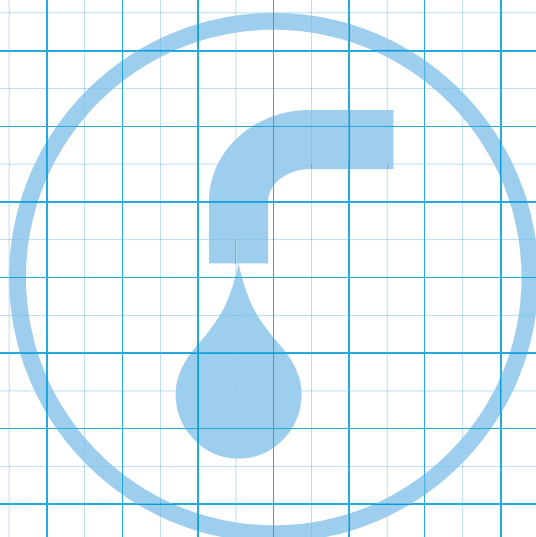





FV
PLAST®

PLASTIC FITTINGS

FV PPR compensation pipe

System: **FV AQUA**
 Material: PPR
 Standard: ČSN EN ISO 15874, DIN 8077, DIN 8078
 Details: Preventing deformations in a piping system caused by thermal expansion.

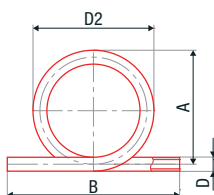

DN	⊕	⊞	⊞	⊞	dm ³	# ●	# ●	# ●	D [mm]	D2 [mm]	A [mm]	B [mm]
16	pcs	10	1	0,07	1,60	AA232016000	BA232016000	WA232016000	16	188,0	180	290
20	pcs	6	1	0,11	1,60	AA232020000	BA232020000	WA232020000	20	210,0	200	300
25	pcs	5	1	0,21	3,20	AA232025000	BA232025000	WA232025000	25	217,5	205	370
32	pcs	4	1	0,43	8,00	AA232032000	BA232032000	WA232032000	32	231,0	215	400
40	pcs	2	1	0,67	8,00	AA232040000	BA232040000	WA232040000	40	295,0	275	420

FV PPR crossover

System: **FV AQUA**
 Material: PPR
 Standard: ČSN EN ISO 15874, DIN 8077, DIN 8078
 Details: For pipe crossing in case of branching, connection to a fitting.

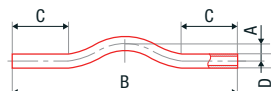

DN	⊕	⊞	⊞	⊞	dm ³	# ●	# ●	# ●	D [mm]	A [mm]	B [mm]	C [mm]
16	pcs	180	1	0,03	0,24	AA233016000	BA233016000	WA233016000	16	35	380	100
20	pcs	100	1	0,07	0,32	AA233020000	BA233020000	WA233020000	20	42	400	110
25	pcs	50	1	0,09	0,64	AA233025000	BA233025000	WA233025000	25	30	400	100
32	pcs	35	1	0,16	0,80	AA233032000	BA233032000	WA233032000	32	35	400	90
40	pcs	20	1	0,33	1,60	AA233040000	BA233040000	WA233040000	40	35	400	90

FV PPR crossover with socket

System: **FV AQUA**
 Material: PPR
 Standard: ČSN EN ISO 15874, DIN 8077, DIN 8078
 Details: For pipe crossing in case of branching, connection to a pipe.

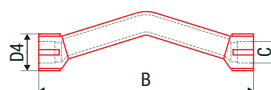

DN	⊕	⊞	⊞	⊞	dm ³	# ●	# ●	# ●	D4 [mm]	B [mm]	C [mm]
20	pcs	100	1	0,07	0,24	AA246020000	BA246020000	WA246020000	31	188	20
25	pcs	50	1	0,09	0,32	AA246025000	BA246025000	WA246025000	37	198	25

FV PPR elbow 90°

System: **FV AQUA**
 Material: PPR
 Standard: ČSN EN ISO 15874, DIN 8077, DIN 8078
 Details: A simple, reliable fitting for changing the pipeline direction.

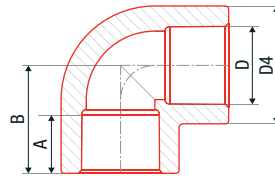

mm	pcs	200	50	0,01	0,05	# ●	# ●	# ●	D [mm]	D4 [mm]	A [mm]	B [mm]
16	pcs	200	50	0,01	0,05	AA202016000	BA202016000	WA202016000	16	24	13,3	22,0
20	pcs	300	50	0,02	0,07	AA202020000	BA202020000	WA202020000	20	29	14,5	25,5
25	pcs	150	25	0,03	0,12	AA202025000	BA202025000	WA202025000	25	37	16,0	29,0
32	pcs	80	10	0,06	0,24	AA202032000	BA202032000	WA202032000	32	46	18,1	34,2
40	pcs	40	4	0,11	0,53	AA202040000	BA202040000	WA202040000	40	60	20,5	41,5
50	pcs	30	2	0,19	0,96	AA202050000	BA202050000	WA202050000	50	73	23,5	48,5
63	pcs	10	2	0,37	1,92	AA202063000	BA202063000	WA202063000	63	94	27,4	59,2
75	pcs	6	1	0,52	3,20	AA202075000	BA202075000	WA202075000	75	108	31,0	67,7
90	pcs	6	1	0,79	4,80	AA202090000	BA202090000	WA202090000	90	126	35,5	78,4
110	pcs	3	1	1,38	5,50	AA202110000	BA202110000	WA202110000	110	151	41,5	98,0
125	pcs	1	1				BA202125000		125	165	40	124

FV PPR elbow 90° reduced

System: **FV AQUA**
 Material: PPR
 Standard: ČSN EN ISO 15874, DIN 8077, DIN 8078
 Details: A simple, reliable fitting for changing the pipeline direction and dimension.

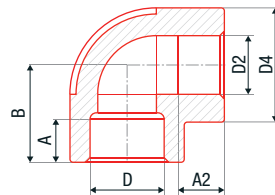

mm	pcs	50	1	0,09	0,32	# ●	# ●	# ●	D [mm]	D2 [mm]	D4 [mm]	A [mm]	B [mm]
25	pcs	50	1	0,09	0,32	AA211025020	BA211025020	WA211025020	25	20	36,3	16	32,2

FV PPR elbow 45°

System: **FV AQUA**
 Material: PPR
 Standard: ČSN EN ISO 15874, DIN 8077, DIN 8078
 Details: A simple, reliable fitting for changing the pipeline direction.

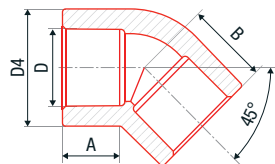

mm	pcs	200	50	0,01	0,03	# ●	# ●	# ●	D [mm]	D4 [mm]	A [mm]	B [mm]
16	pcs	200	50	0,01	0,03	AA203016000	BA203016000	WA203016000	16	24,3	13,3	17,5
20	pcs	300	50	0,02	0,07	AA203020000	BA203020000	WA203020000	20	29,1	14,5	19,5
25	pcs	150	25	0,03	0,12	AA203025000	BA203025000	WA203025000	25	36,8	16,0	22,0
32	pcs	80	10	0,06	0,24	AA203032000	BA203032000	WA203032000	32	46,0	18,1	25,5
40	pcs	40	4	0,11	0,53	AA203040000	BA203040000	WA203040000	40	59,0	20,5	30,0
50	pcs	30	2	0,19	0,96	AA203050000	BA203050000	WA203050000	50	74,85	23,5	34,5
63	pcs	10	2	0,37	1,92	AA203063000	BA203063000	WA203063000	63	94,0	27,4	44,5
75	pcs	6	1	0,52	3,20	AA203075000	BA203075000	WA203075000	75	99,0	30,0	48,0
90	pcs	6	1	0,79	4,80	AA203090000	BA203090000	WA203090000	90	120	33,0	54,1
110	pcs	3	1	1,38	5,50	AA203110000	BA203110000	WA203110000	110	148	37,0	69,0
125	pcs	1	1				BA203125000		125	165	40,0	77,0

FV PPR elbow 90° internal / external

System: **FV AQUA**
 Material: PPR
 Standard: ČSN EN ISO 15874, DIN 8077, DIN 8078
 Details: A simple, reliable fitting for changing the pipeline direction.

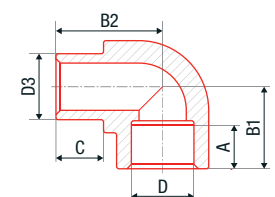

mm	pcs	400	50	0,01	0,05	# ●	# ●	# ●	D, D3 [mm]	A [mm]	B1 [mm]	B2 [mm]	C [mm]
20	pcs	400	50	0,01	0,05	AA204020000	BA204020000	WA204020000	20	14,5	25,6	29,0	14,5
25	pcs	200	25	0,03	0,14	AA204025000	BA204025000	WA204025000	25	16,0	31,5	35,4	14,8
32	pcs	100	20	0,07	0,22	AA204032000	BA204032000	WA204032000	32	18,0	36,5	42,2	16,0

FV PPR elbow 45° internal / external

System: **FV AQUA**
 Material: PPR
 Standard: ČSN EN ISO 15874, DIN 8077, DIN 8078
 Details: A simple, reliable fitting for changing the pipeline direction.

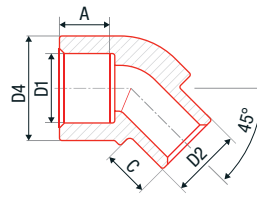

Icon	⊕	⊞	⊞	🔒	dm ²	# ●	# ●	# ●	D1 [mm]	D2 [mm]	D4 [mm]	A [mm]	C [mm]
16	pcs	280	20	0,010	0,04	AA205016000	BA205016000	WA205016000	16	16	24,2	13,3	12,5
20	pcs	200	20	0,020	0,07	AA205020000	BA205020000	WA205020000	20	20	29,5	14,5	14,8
25	pcs	100	10	0,026	0,07	AA205025000			25	25	36,3	18,3	17,3

FV PPR elbow 90° for wall mounting welding

System: **FV AQUA**
 Material: PPR
 Standard: ČSN EN ISO 15874, DIN 8077, DIN 8078
 Details: Fixing fitting with tap connector for mixers.

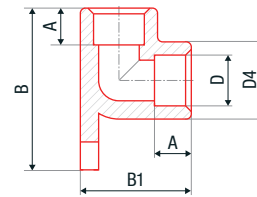

Icon	⊕	⊞	⊞	🔒	dm ²	# ●	# ●	# ●	D [mm]	D4 [mm]	A [mm]	B [mm]	B1 [mm]
20	pcs	60	10	0,02	0,16	AA206020000	BA206020000	WA206020000	20	30,2	14,5	48,5	43,5
25	pcs	40	10	0,04	0,32	AA206025000	BA206025000	WA206025000	25	35,3	16,0	76,2	51,0

FV PPR reduction internal / external

System: **FV AQUA**
 Material: PPR
 Standard: ČSN EN ISO 15874, DIN 8077, DIN 8078
 Details: A simple, reliable fitting for dimension change of pipeline.

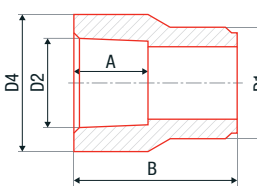

Icon	⊕	⊞	⊞	🔒	dm ²	# ●	# ●	# ●	D1 [mm]	D2 [mm]	D4 [mm]	A [mm]	B [mm]
20 × 16	pcs	400	50	0,01	0,02	AA210020016	BA210020016	WA210020016	20	16	24,0	13,3	28,4
25 × 16	pcs	300	50	0,01	0,03	AA210025016	BA210025016	WA210025016	25	16	30,1	13,3	31,8
25 × 20	pcs	400	50	0,01	0,05	AA210025020	BA210025020	WA210025020	25	20	30,1	14,5	34,2
32 × 20	pcs	300	10	0,03	0,13	AA210032020	BA210032020	WA210032020	32	20	33,8	14,5	35,4
32 × 25	pcs	200	10	0,03	0,12	AA210032025	BA210032025	WA210032025	32	25	36,0	16,0	38,9
40 × 20	pcs	180	10	0,02	0,13	AA210040020	BA210040020	WA210040020	40	20	40,0	14,5	41,5
40 × 25	pcs	180	10	0,03	0,16	AA210040025	BA210040025	WA210040025	40	25	37,9	16,0	43,5
40 × 32	pcs	120	10	0,04	0,24	AA210040032	BA210040032	WA210040032	40	32	47,3	18,1	50,7
50 × 32	pcs	80	10	0,05	0,27	AA210050032	BA210050032	WA210050032	50	32	50,3	18,1	50,6
50 × 40	pcs	60	10	0,05	0,30	AA210050040	BA210050040	WA210050040	50	40	60,5	20,5	49,8
63 × 32	pcs	60	10	0,07	0,32	AA210063032	BA210063032	WA210063032	63	32	48,2	18,1	43,5
63 × 40	pcs	50	10	0,08	0,40	AA210063040	BA210063040	WA210063040	63	40	59,7	20,5	52,0
63 × 50	pcs	40	10	0,12	0,60	AA210063050	BA210063050	WA210063050	63	50	74,3	23,5	62,0
75 × 40	pcs	20	5	0,12	0,60	AA210075040	BA210075040	WA210075040	75	40	93,2	20,5	64,5
75 × 50	pcs	20	5	0,12	0,80	AA210075050	BA210075050	WA210075050	75	50	93,2	23,5	57,5
75 × 63	pcs	24	2	0,21	1,37	AA210075063	BA210075063	WA210075063	75	63	93,2	27,4	72,2
90 × 63	pcs	25	1	0,24	0,98	AA210090063	BA210090063	WA210090063	90	63	94,8	27,4	70,8
90 × 75	pcs	20	1	0,27	2,40	AA210090075	BA210090075	WA210090075	90	75	106,0	31,0	73,2
110 × 75	pcs	1	1	0,30	1,32	AA210110075	BA210110075	WA210110075	110	75	125,8	30,0	64,0
110 × 90	pcs	9	1	0,50	2,80	AA210110090	BA210110090	WA210110090	110	90	125,8	35,5	91,7
125 × 110	pcs	1	1				BA210125110		125	110	134,6	85,0	225

FV PPR three-way elbow

System: **FV AQUA**
 Material: PPR
 Standard: ČSN EN ISO 15874, DIN 8077, DIN 8078
 Details: A simple, reliable fitting for branching the pipeline.

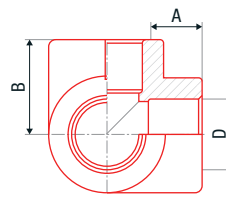

Icon	⊕	⊞	⊠	🔒	dm³	# ●	# ●	# ●	D [mm]	A [mm]	B [mm]	
	20	pcs	50	10	0,03	0,13	AA242020000	BA242020000	WA242020000	20	14,5	26,8
	25	pcs	50	10	0,04	0,17	AA242025000	BA242025000	WA242025000	25	16,0	29,5
	32	pcs	20	5	0,05	0,20	AA242032000	BA242032000	WA242032000	32	18,0	35,0

FV PPR socket

System: **FV AQUA**
 Material: PPR
 Standard: ČSN EN ISO 15874, DIN 8077, DIN 8078
 Details: A simple, reliable fitting for pipe connection.

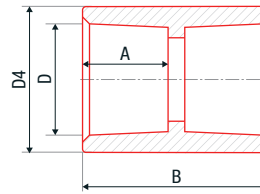

Icon	⊕	⊞	⊠	🔒	dm³	# ●	# ●	# ●	D [mm]	D4 [mm]	A [mm]	B [mm]	
	16	pcs	300	50	0,01	0,03	AA201016000	BA201016000	WA201016000	16	24,10	13,3	29,6
	20	pcs	400	50	0,01	0,05	AA201020000	BA201020000	WA201020000	20	29,10	14,5	32,0
	25	pcs	200	25	0,03	0,10	AA201025000	BA201025000	WA201025000	25	36,70	16,0	35,5
	32	pcs	100	10	0,04	0,19	AA201032000	BA201032000	WA201032000	32	46,20	18,1	38,3
	40	pcs	100	10	0,06	0,24	AA201040000	BA201040000	WA201040000	40	59,50	20,5	45,4
	50	pcs	40	4	0,11	0,60	AA201050000	BA201050000	WA201050000	50	73,00	23,5	50,8
	63	pcs	30	2	0,19	0,87	AA201063000	BA201063000	WA201063000	63	90,30	27,4	58,5
	75	pcs	15	1	0,27	1,92	AA201075000	BA201075000	WA201075000	75	108,5	31,0	66,5
	90	pcs	10	1	0,42	2,40	AA201090000	BA201090000	WA201090000	90	127,3	35,5	73,6
	110	pcs	4	1	0,67	2,80	AA201110000	BA201110000	WA201110000	110	152,7	41,5	87,2
	125	pcs	1	1			AA201125000	BA201125000		125	165,0	40,0	90,0

FV PPR reduction

System: **FV AQUA**
 Material: PPR
 Standard: ČSN EN ISO 15874, DIN 8077, DIN 8078
 Details: A simple, reliable fitting for dimension change of pipeline.

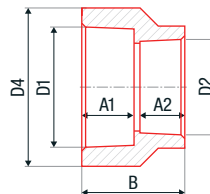

Icon	⊕	⊞	⊠	🔒	dm³	# ●	# ●	# ●	D1 [mm]	D2 [mm]	D4 [mm]	A1/A2 [mm]	B [mm]	
	20 x 16	pcs	200	50	0,01	0,05	AA209020016	BA209020016	WA209020016	20	16	29,0	14,5/13,3	33,0
	25 x 20	pcs	300	50	0,02	0,11	AA209025020	BA209025020	WA209025020	25	20	36,7	16/14,5	34,3
	32 x 20	pcs	180	10	0,02	0,13	AA209032020	BA209032020	WA209032020	32	20	46,3	18,1/14,5	35,0
	32 x 25	pcs	150	10	0,03	0,13	AA209032025	BA209032025	WA209032025	32	25	47,1	18,1/16	38,0
	40 x 32	pcs	Order kindly equivalent adaptor inner / outer 63 x 32											
	50 x 40	pcs	40	4	0,09	0,60	AA209050040	BA209050040	WA209050040	50	40		23,5/20,5	47,0
	63 x 50	pcs	24	2	0,17	0,80	AA209063050	BA209063050	WA209063050	63	50	93,2	27,4/23,5	54,0

FV PPR bend

System: **FV AQUA**
 Material: PPR
 Standard: ČSN EN ISO 15874, DIN 8077, DIN 8078
 Details: For change of direction with lower pressure losses.

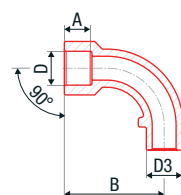

Icon	⊕	⊞	⊠	🔒	dm³	# ●	# ●	# ●	D [mm]	D3 [mm]	A [mm]	B [mm]
	20	pcs	100	10	0,03	0,12	AA241020000		20	20	13	56

FV PPR tee

System: **FV AQUA**
 Material: PPR
 Standard: ČSN EN ISO 15874, DIN 8077, DIN 8078
 Details: A simple, reliable fitting for branching the pipeline.

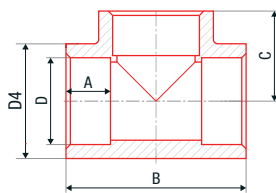

Code	Unit	Quantity	Weight [kg]	Volume [dm ³]	Material #	Material #	Material #	D [mm]	D4 [mm]	A [mm]	B [mm]	C [mm]
16	pcs	150	0,02	0,08	AA208016000	BA208016000	WA208016000	16	24,6	13,3	44	23,0
20	pcs	160	0,03	0,12	AA208020000	BA208020000	WA208020000	20	29,0	14,5	51	25,5
25	pcs	120	0,04	0,24	AA208025000	BA208025000	WA208025000	25	36,5	16,0	59	31,4
32	pcs	60	0,08	0,40	AA208032000	BA208032000	WA208032000	32	45,3	18,1	71	35,0
40	pcs	48	0,13	0,96	AA208040000	BA208040000	WA208040000	40	58,0	20,5	83	41,5
50	pcs	22	0,25	1,60	AA208050000	BA208050000	WA208050000	50	74,0	23,5	99	49,0
63	pcs	9	0,46	2,74	AA208063000	BA208063000	WA208063000	63	93,0	27,4	120	60,0
75	pcs	6	0,62	3,20	AA208075000	BA208075000	WA208075000	75	108,0	31,0	137	68,5
90	pcs	5	0,99	4,80	AA208090000	BA208090000	WA208090000	90	128,5	35,5	163	80,5
110	pcs	2	1,78	5,50	AA208110000	BA208110000	WA208110000	110	152,6	41,5	186	97,0
125	pcs	1				BA208125000		125	165,0	40,0	248	124

FV PPR tee reduced

System: **FV AQUA**
 Material: PPR
 Standard: ČSN EN ISO 15874, DIN 8077, DIN 8078
 Details: A simple, reliable fitting for branching the pipeline.

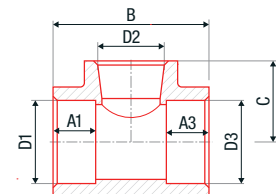

Code	Unit	Quantity	Weight [kg]	Volume [dm ³]	Material #	Material #	Material #	D1 [mm]	D2 [mm]	D3 [mm]	B [mm]	C [mm]
20 x 16 x 20	pcs	100	0,03	0,10	AA212020016	BA212020016	WA212020016	20	16	20	52,2	27,4
20 x 25 x 20	pcs	100	0,03	0,24	AA212020025	BA212020025	WA212020025	20	25	20	64,0	27,0
25 x 20 x 20	pcs	50	0,05	0,24	AA212025021	BA212025021	WA212025021	25	20	20	58,8	31,6
25 x 20 x 25	pcs	120	0,04	0,24	AA212025020	BA212025020	WA212025020	25	20	25	58,5	31,6
32 x 20 x 32	pcs	90	0,07	0,38	AA212032020	BA212032020	WA212032020	32	20	32	61,4	31,5
32 x 25 x 32	pcs	80	0,07	0,38	AA212032025	BA212032025	WA212032025	32	25	32	69,1	36,0
40 x 20 x 40	pcs	60	0,09	0,46	AA212040020	BA212040020	WA212040020	40	20	40	64,0	38,1
40 x 25 x 40	pcs	50	0,13	0,64	AA212040025	BA212040025	WA212040025	40	25	40	73,5	39,6
40 x 32 x 40	pcs	50	0,13	0,64	AA212040032	BA212040032	WA212040032	40	32	40	79,3	42,4
50 x 25 x 50	pcs	40	0,18	0,96	AA212050025	BA212050025	WA212050025	50	25	50	76,3	49,7
50 x 32 x 50	pcs	30	0,19	0,96	AA212050032	BA212050032	WA212050032	50	32	50	82,6	45,9
50 x 40 x 50	pcs	14	0,21	0,96	AA212050040	BA212050040	WA212050040	50	40	50	90,3	47,7
63 x 32 x 63	pcs	10	0,35	1,92	AA212063032	BA212063032	WA212063032	63	32	63	94,7	52,3
63 x 40 x 63	pcs	10	0,34	1,92	AA212063040	BA212063040	WA212063040	63	40	63	98,7	53,9
63 x 50 x 63	pcs	10	0,39	1,92	AA212063050	BA212063050	WA212063050	63	50	63	107,3	56,8
90 x 63 x 90	pcs	5	0,77	4,80	AA212090063	BA212090063	WA212090063	90	63	90	132,9	73,4
90 x 75 x 90	pcs	5	0,85	4,80	AA212090075	BA212090075	WA212090075	90	75	90	142,6	76,4
125 x 75 x 125	pcs	1				BA212125075		125	75	125	248,0	104,0
125 x 90 x 125	pcs	1				BA212125090		125	90	125	248,0	106,0
125 x 110 x 125	pcs	1				BA212125110		125	110	125	248,0	110,0

FV PPR cross piece

System: **FV AQUA**
 Material: PPR
 Standard: ČSN EN ISO 15874, DIN 8077, DIN 8078
 Details: A simple, reliable fitting for branching the pipeline.

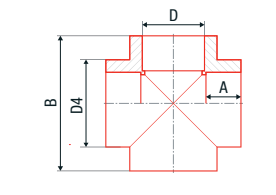

Code	Unit	Quantity	Weight [kg]	Volume [dm ³]	Material #	Material #	Material #	D [mm]	D4 [mm]	A [mm]	B [mm]
20	pcs	100	0,03	0,16	AA235020000	BA235020000	WA235020000	20	31	14,5	51,0
25	pcs	100	0,04	0,24	AA235025000	BA235025000	WA235025000	25	38	16,0	59,2
32	pcs	50	0,06	0,32	AA235032000	BA235032000	WA235032000	32	42	18,0	64,0

FV PPR reducing sleeve with plastic male thread

System: **FV AQUA**
 Material: PPR
 Standard: ČSN EN ISO 15874, DIN 8077, DIN 8078
 Details: A fitting for temporary threaded connection.

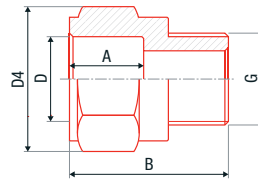

Icon	⊕	⊞	⊞	⊞	⊞	# ●	# ●	# ●	D [mm]	D4 [mm]	A [mm]	B [mm]	G [mm]
20 × 1/2"	pcs	300	20	0,01	0,03	AA213020000	BA213020000	WA213020000	20	30,8	14,5	34,5	1/2"
20 × 3/4"	pcs	100	20	0,02	0,04	AA213021000	BA213021000	WA213021000	20	36,4	14,5	44,5	3/4"
25 × 3/4"	pcs	100	20	0,02	0,05	AA213025000	BA213025000	WA213025000	25	40,5	16,0	45,0	3/4"
32 × 1"	pcs	100	10	0,03	0,10	AA213032000	BA213032000	WA213032000	32	50,0	18,1	55,0	1"
40 × 5/4"	pcs	60	10	0,07	0,20	AA213040000	BA213040000	WA213040000	40	68,2	20,5	56,8	5/4"
50 × 6/4"	pcs	40	10	0,12	0,35	AA213050000	BA213050000	WA213050000	50	84,8	23,5	65,0	6/4"
63 × 2"	pcs	20	2	0,22	0,50	AA213063000	BA213063000	WA213063000	63	107,0	27,4	75,0	2"

FV PPR tap elbow for welding internal

System: **FV AQUA**
 Material: PPR
 Standard: ČSN EN ISO 15874, DIN 8077, DIN 8078
 Details: A fitting for temporary threaded connection.

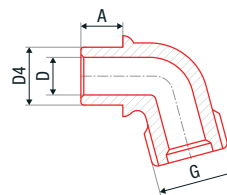

Icon	⊕	⊞	⊞	⊞	⊞	# ●	# ●	# ●	D [mm]	D4 [mm]	A [mm]	G [mm]
20 × 3/4"	pcs	150	10	0,02	0,08	AA207020000	BA207020000	WA207020000	20	23,0	14,5	3/4"
25 × 1"	pcs	100	10	0,03	0,10	AA207025000	BA207025000	WA207025000	25	28,5	16,0	1"

FV PPR threaded tap connector (fast)

System: **FV AQUA**
 Material: PPR
 Standard: ČSN EN ISO 15874, DIN 8077, DIN 8078
 Details: A connecting fitting for garden irrigation systems.

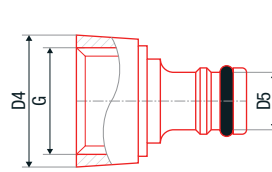

Icon	⊕	⊞	⊞	⊞	⊞	# ●	# ●	# ●	D4 [mm]	D5 [mm]	G [mm]
20 × 3/4"	pcs	250	50	0,01	0,05	AA256020034	BA256020034	WA256020034	32,7	15,6	3/4"
25 × 1"	pcs	250	50	0,01	0,08	AA256025001	BA256025001	WA256025001	38,6	15,6	1"

FV PPR blinding

System: **FV AQUA**
 Material: PPR
 Standard: ČSN EN ISO 15874, DIN 8077, DIN 8078
 Details: For permanent or temporary blinding of a branch.

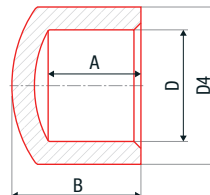

Icon	⊕	⊞	⊞	⊞	⊞	# ●	# ●	# ●	D [mm]	D4 [mm]	A [mm]	B [mm]
16	pcs	500	50	0,01	0,02	AA229016000	BA229016000	WA229016000	16	23,5	13,3	18,5
20	pcs	300	20	0,01	0,04	AA229020000	BA229020000	WA229020000	20	30,3	14,5	21,0
25	pcs	200	20	0,01	0,05	AA229025000	BA229025000	WA229025000	25	37,0	16,0	25,0
32	pcs	120	10	0,03	0,12	AA229032000	BA229032000	WA229032000	32	46,0	18,1	31,0
40	pcs	60	10	0,05	0,24	AA229040000	BA229040000	WA229040000	40	57,3	20,5	32,5
50	pcs	60	4	0,09	0,30	AA229050000	BA229050000	WA229050000	50	73,5	23,5	41,0
63	pcs	30	2	0,15	0,40	AA229063000	BA229063000	WA229063000	63	89,3	27,4	46,0
75	pcs	5	1	0,26	0,50	AA229075000	BA229075000	WA229075000	75	107,0	30,0	60,0
90	pcs	5	1	0,42	0,60	AA229090000	BA229090000	WA229090000	90	127,0	33,0	69,0
110	pcs	1	1	0,53	0,70	AA229110000	BA229110000	WA229110000	110	151,3	37,0	79,0
125	pcs	1	1				BA229125000		125	165,0	40,0	87,0

FV PPR threaded tap connector

System: **FV AQUA**
 Material: PPR
 Standard: ČSN EN ISO 15874, DIN 8077, DIN 8078
 Details: A connecting fitting for garden irrigation systems.

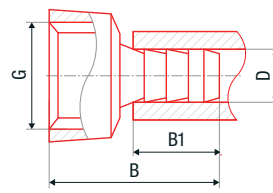

Icon	⊕	⊞	⊞	⊞	dm ³	# ●	# ●	# ●	D [mm]	B [mm]	B1 [mm]	G [mm]
20 × 3/4"	pcs	450	50	0,01	0,05	AA280020034	BA280020034	WA280020034	20	41,1	24,0	3/4"
25 × 1"	pcs	300	25	0,01	0,08	AA280025001	BA280025001	WA280025001	25	46,0	27,4	1"

FV PPR blinding internal

System: **FV AQUA**
 Material: PPR
 Standard: ČSN EN ISO 15874, DIN 8077, DIN 8078
 Details: For permanent or temporary blinding of a branch.

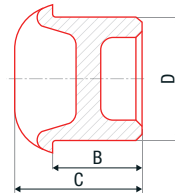

Icon	⊕	⊞	⊞	⊞	dm ³	# ●	# ●	# ●	D [mm]	B [mm]	C [mm]
20	pcs	160	40	0,01	0,04	AA245020000	BA245020000	WA245020000	20	23,5	14,5
25	pcs	200	50	0,01	0,06	AA245025000	BA245025000	WA245025000	25	29,0	16,0

FV PPR pressure plug short

System: **FV AQUA**
 Material: PPR
 Standard: ČSN EN ISO 15874, DIN 8077, DIN 8078
 Details: For protection against mechanic impurities, non-pressure fitting.

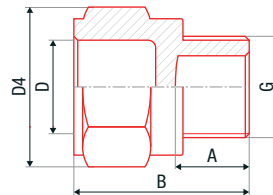

Icon	⊕	⊞	⊞	⊞	dm ³	# ●	# ●	# ●	D [mm]	D4 [mm]	A [mm]	B [mm]	G [mm]
1/2"	pcs	400	50	0,01	0,04	AA253000000	BA253000000	WA253000000	20	30,8	14,5	34,5	1/2"

FV PPR all plastic weld in saddle

System: **FV AQUA**
 Material: PPR
 Standard: ČSN EN ISO 15874, DIN 8077, DIN 8078
 Details: For additional branches from existing pipeline.

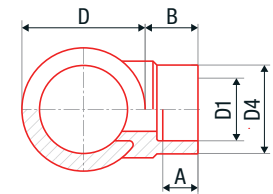

Icon	⊕	⊞	⊞	⊞	dm ³	# ●	# ●	# ●	D [mm]	D1 [mm]	D4 [mm]	A [mm]	B [mm]
63 × 32	pcs	120	10	0,036	0,150	AA238063032	BA238063032	WA238063032	63	32	46,0	18	27
75 × 32	pcs	120	10	0,036	0,150	AA238075032	BA238075032	WA238075032	75	32	46,0	18	27
90 × 32	pcs	120	10	0,036	0,150	AA238090032	BA238090032	WA238090032	90	32	46,0	18	27
110 × 32	pcs	120	10	0,036	0,150	AA238110032	BA238110032	WA238110032	110	32	46,0	18	25,7
110 × 40	pcs	1	1	0,048	0,107	AA238110040	BA238110040	WA238110040	110	40	57,2	20,5	27
125 × 20	pcs	1	1	0,025	0,040		BA238125020		125	20	28,3	14,5	29
125 × 25	pcs	1	1	0,022	0,040		BA238125025		125	25	37,5	16	29
125 × 32	pcs	1	1	0,035	0,092		BA238125032		125	32	46,0	18	35
125 × 40	pcs	1	1	0,083	0,150		BA238125040		125	40	57,2	20,5	38
125 × 50	pcs	1	1	0,098	1,189		BA238125050		125	50	67,0	23,5	39
125 × 63	pcs	1	1	0,163	0,312		BA238125063		125	63	93,0	27	45

FV PPR washer

System: **FV AQUA**
 Material: PPR
 Standard: ČSN EN ISO 15874, DIN 8077, DIN 8078
 Details: Delimitation of strengthening distribution within the installation in core housing.

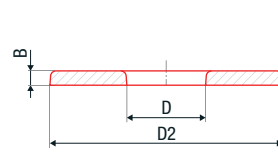

QTY	UNIT	QTY	QTY	QTY	QTY	#	#	#	D [mm]	D2 [mm]	B [mm]
66 x 22	pcs	300	1	0,01	0,01	AA251000000	BA251000000	WA251000000	21,3	64,8	4,3

FV PPR pressure plug long

System: **FV AQUA**
 Material: PPR
 Standard: -
 Details: Temporary closure of threaded fittings for pressure test.

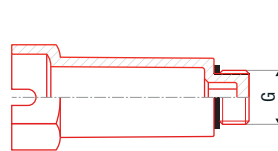

QTY	UNIT	QTY	QTY	QTY	QTY	#	#	#	Color
1/2"	pcs	120	10	0,02	0,14	AA252001012			blue
1/2"	pcs	120	10	0,02	0,14		AA252002012		red
1/2"	pcs	120	10	0,02	0,14			AA252003012	black ECO

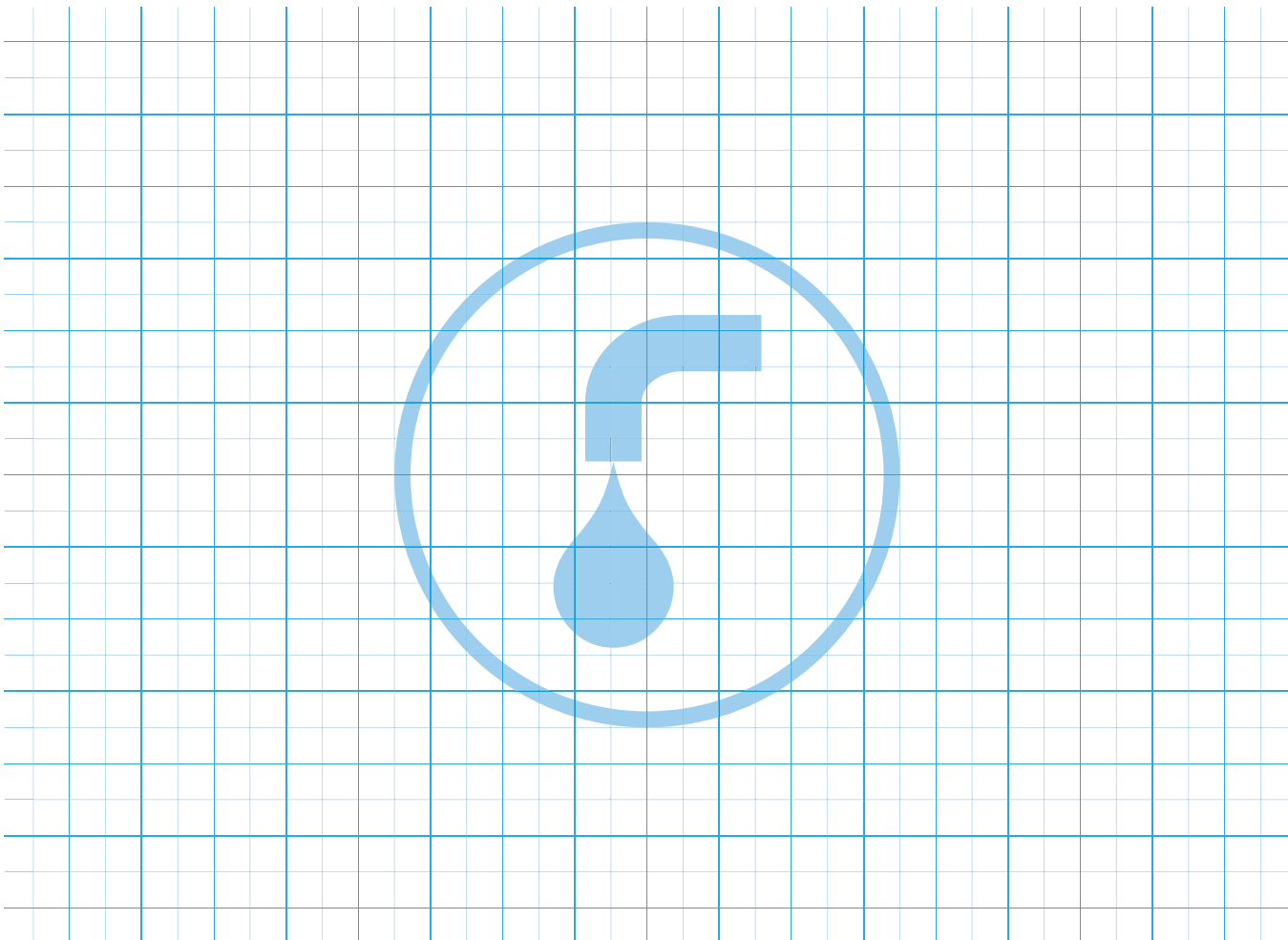

COMBINATION FITTINGS

FV PPR elbow 90° with metal female thread

System: **FV AQUA**
 Material: PPR - brass
 Standard: ČSN EN ISO 15874, DIN 8077, DIN 8078
 Details: Transition fitting from plastic part to metal part of pipeline.

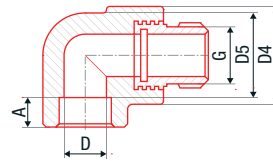

Size	Unit	Quantity	Weight	Volume	Material	AA	BA	WA	D [mm]	D4 [mm]	D5 [mm]	A [mm]	G [mm]
16 x 1/2"	pcs	120	10	0,07	0,16	AA216016012	BA216016012	WA216016012	16	39,0	30,4	13,5	1/2"
20 x 1/2"	pcs	70	10	0,09	0,16	AA216020012	BA216020012	WA216020012	20	35,0	30,8	14,5	1/2"
20 x 3/4"	pcs	50	10	0,14	0,32	AA216020034	BA216020034	WA216020034	20	45,5	30,2	14,5	3/4"
25 x 1/2"	pcs	60	10	0,13	0,32	AA216025012	BA216025012	WA216025012	25	37,5	36,0	16,0	1/2"
25 x 3/4"	pcs	40	10	0,15	0,32	AA216025034	BA216025034	WA216025034	25	45,7	36,5	16,0	3/4"
32 x 1"	pcs	40	5	0,22	0,60	AA216032001	BA216032001	WA216032001	32	56,6	49,0	18,1	1"

FV PPR reducing sleeve with metal male thread

System: **FV AQUA**
 Material: PPR - brass
 Standard: ČSN EN ISO 15874, DIN 8077, DIN 8078
 Details: Transition fitting from plastic part to metal part of pipeline.

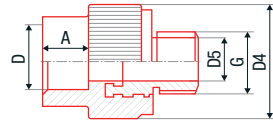

Size	Unit	Quantity	Weight	Volume	Material	AA	BA	WA	D [mm]	D4 [mm]	D5 [mm]	A [mm]	G [mm]
16 x 1/2"	pcs	100	10	0,09	0,10	AA215016012	BA215016012	WA215016012	16	36,0	32,3	13,3	1/2"
20 x 1/2"	pcs	100	10	0,08	0,10	AA215020012	BA215020012	WA215020012	20	34,3	29,9	14,5	1/2"
20 x 3/4"	pcs	70	10	0,14	0,16	AA215020034	BA215020034	WA215020034	20	41,3	29,4	14,5	3/4"
25 x 1/2"	pcs	50	10	0,10	0,15	AA215025012	BA215025012	WA215025012	25	35,2	35,5	16,0	1/2"
25 x 3/4"	pcs	60	10	0,14	0,16	AA215025034	BA215025034	WA215025034	25	42,4	36,2	16,0	3/4"
32 x 1"	pcs	80	10	0,19	0,27	AA215032001	BA215032001	WA215032001	32	50,6	46,3	18,1	1"
40 x 5/4"	pcs	40	4	0,31	0,46	AA215040054	BA215040054	WA215040054	40	66,8	59,2	20,5	5/4"
50 x 6/4"	pcs	20	4	0,34	0,69	AA215050064	BA215050064	WA215050064	50	67,4	74,5	23,5	6/4"
63 x 2"	pcs	12	1	0,73	1,37	AA215063002	BA215063002	WA215063002	63	85,8	92,0	27,4	2"
75 x 2,5"	pcs	9	1	1,11	2,74	AA215075025	BA215075025	WA215075025	75	106,0	106,8	31,0	2,5"
90 x 3"	pcs	6	1	1,64	3,20	AA215090003	BA215090003	WA215090003	90	123,0	126,0	35,5	3"
125 x 5"	pcs	1	1				BA215125005		125	168,0	206	40	5"

FV PPR reducing sleeve with metal female thread

System: **FV AQUA**
 Material: PPR - brass
 Standard: ČSN EN ISO 15874, DIN 8077, DIN 8078
 Details: Transition fitting from plastic part to metal part of pipeline.

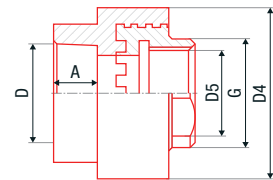

Size	Unit	Quantity	Weight	Volume	Material	AA	BA	WA	D [mm]	D4 [mm]	D5 [mm]	A [mm]	G [mm]
16 x 1/2"	pcs	100	10	0,06	0,10	AA217016012	BA217016012	WA217016012	16	39,2	32,2	13,3	1/2"
20 x 1/2"	pcs	100	10	0,06	0,10	AA217020012	BA217020012	WA217020012	20	40,0	30,0	14,5	1/2"
20 x 3/4"	pcs	70	10	0,11	0,16	AA217020034	BA217020034	WA217020034	20	45,5	29,3	14,5	3/4"
25 x 1/2"	pcs	100	10	0,06	0,16	AA217025012	BA217025012	WA217025012	20	39,5	36,0	16,0	1/2"
25 x 3/4"	pcs	60	10	0,10	0,16	AA217025034	BA217025034	WA217025034	25	45,4	36,0	16,0	3/4"
32 x 1"	pcs	60	10	0,18	0,27	AA217032001	BA217032001	WA217032001	32	57,5	46,5	18,1	1"
40 x 5/4"	pcs	25	5	0,31	0,46	AA217040054	BA217040054	WA217040054	40	76,8	60,3	20,5	5/4"
50 x 6/4"	pcs	20	2	0,37	0,69	AA217050064	BA217050064	WA217050064	50	82,7	74,3	23,5	6/4"
63 x 2"	pcs	10	1	0,66	1,37	AA217063002	BA217063002	WA217063002	63	107,0	94,0	27,4	2"
125 x 5"	pcs	1	1				BA217125005		125	206,0	168,0	40,0	5"

FV PPR elbow 90° with metal female thread

System: **FV AQUA**
 Material: PPR - brass
 Standard: ČSN EN ISO 15874, DIN 8077, DIN 8078
 Details: Transition fitting from plastic part to metal part of pipeline.

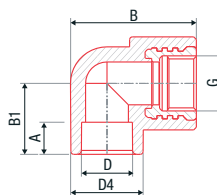

Objekt	Symbol	Objekt	Objekt	Objekt	Objekt	# ●	# ●	# ●	D [mm]	D4 [mm]	D5 [mm]	A [mm]	G [mm]
16 x 1/2"	pcs	150	10	0,07	0,16	AA218016012	BA218016012	WA218016012	16	39,0	30,2	13,5	1/2"
20 x 1/2"	pcs	80	10	0,06	0,16	AA218020012	BA218020012	WA218020012	20	35,0	29,8	14,5	1/2"
20 x 3/4"	pcs	50	10	0,13	0,32	AA218020034	BA218020034	WA218020034	20	45,5	30,0	14,5	3/4"
25 x 1/2"	pcs	60	10	0,10	0,32	AA218025012	BA218025012	WA218025012	25	37,5	36,4	16,0	1/2"
25 x 3/4"	pcs	50	10	0,12	0,32	AA218025034	BA218025034	WA218025034	25	45,7	36,0	16,0	3/4"
32 x 1"	pcs	40	5	0,20	0,60	AA218032001	BA218032001	WA218032001	32	56,6	49,0	18,1	1"

FV PPR weld in saddle with metal male thread

System: **FV AQUA**
 Material: PPR - brass
 Standard: ČSN EN ISO 15874, DIN 8077, DIN 8078
 Details: Transition fitting from plastic part to metal part of pipeline, for additional branches.

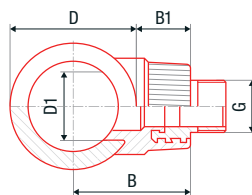

Objekt	Symbol	Objekt	Objekt	Objekt	Objekt	# ●	# ●	# ●	D [mm]	D4 [mm]	B [mm]	B1 [mm]	G [mm]
63 x 3/4"	pcs	120	10	0,11	0,17	AA248063032	BA248063032	WA248063032	63	32	58,5	27	3/4"
75 x 3/4"	pcs	120	10	0,11	0,17	AA248075032	BA248075032	WA248075032	75	32	64,5	27	3/4"
90 x 3/4"	pcs	120	10	0,11	0,17	AA248090032	BA248090032	WA248090032	90	32	72,0	27	3/4"
125 x 25 x 1/2"	pcs	1	1				BA248125025		125	25	105,5	43	1/2"
125 x 32 x 3/4"	pcs	1	1				BA248125032		125	32	112,5	50	3/4"
125 x 40 x 1"	pcs	1	1				BA248125040		125	40	118,5	56	1"
125 x 40 x 5/4"	pcs	1	1				BA248125041		125	40	120,5	58	5/4"
125 x 50 x 5/4"	pcs	1	1				BA248125050		125	50	121,5	59	5/4"
125 x 50 x 6/4"	pcs	1	1				BA248125051		125	50	121,5	59	6/4"
125 x 63 x 2"	pcs	1	1				BA248125063		125	63	132,5	70	2"

FV PPR weld in saddle with metal female thread

System: **FV AQUA**
 Material: PPR - brass
 Standard: ČSN EN ISO 15874, DIN 8077, DIN 8078
 Details: Transition fitting from plastic part to metal part of pipeline, for additional branches.

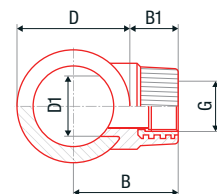

Objekt	Symbol	Objekt	Objekt	Objekt	Objekt	# ●	# ●	# ●	D [mm]	D4 [mm]	B [mm]	B1 [mm]	G [mm]
63 x 3/4"	pcs	120	10	0,08	0,17	AA247063032	BA247063032	WA247063032	63	32	58,5	27	3/4"
75 x 3/4"	pcs	120	10	0,08	0,17	AA247075032	BA247075032	WA247075032	75	32	64,5	27	3/4"
90 x 3/4"	pcs	120	10	0,08	0,17	AA247090032	BA247090032	WA247090032	90	32	72,0	27	3/4"
125 x 25 x 1/2"	pcs	1	1				BA247125025		125	25	105,5	43	1/2"
125 x 32 x 3/4"	pcs	1	1				BA247125032		125	32	112,5	50	3/4"
125 x 40 x 1"	pcs	1	1				BA247125040		125	40	100,5	38	1"
125 x 40 x 5/4"	pcs	1	1				BA247125041		125	40	100,5	38	5/4"
125 x 50 x 5/4"	pcs	1	1				BA247125050		125	50	101,5	39	5/4"
125 x 50 x 6/4"	pcs	1	1				BA247125051		125	50	101,5	39	6/4"
125 x 63 x 2"	pcs	1	1				BA247125063		125	63	107,5	45	2"

FV PPR reducing sleeve with metal female thread with cross

System: **FV AQUA**
 Material: PPR - brass
 Standard: ČSN EN ISO 15874, DIN 8077, DIN 8078
 Details: Transition fitting from plastic part to metal part of pipeline.

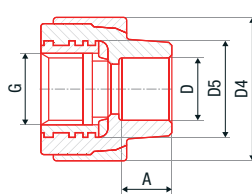

Objekt	Symbol	Objekt	Objekt	Objekt	Objekt	# ●	# ●	# ●	D [mm]	D4 [mm]	D5 [mm]	A [mm]	G [mm]
20 x 1/2" cross	pcs	100	10	0,06	0,11	AA217022012	BA217022012	WA217022012	20	38	28,1	14,5	1/2"

FV PPR tee with metal female thread

System: **FV AQUA**
 Material: PPR - brass
 Standard: ČSN EN ISO 15874, DIN 8077, DIN 8078
 Details: Transition fitting from plastic part to metal part of pipeline.

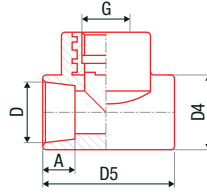

Objekt	Symbol	Skupina	Podskupina	Objem	Objem	# ●	# ●	# ●	D [mm]	D4 [mm]	D5 [mm]	A [mm]	G [mm]
20 x 1/2"	pcs	60	10	0,07	0,19	AA222020012	BA222020012	WA222020012	20	29,0	37,0	14,5	1/2"
25 x 1/2"	pcs	40	10	0,08	0,24	AA222025012	BA222025012	WA222025012	25	36,0	37,0	16,0	1/2"
25 x 3/4"	pcs	30	10	0,13	0,32	AA222025034	BA222025034	WA222025034	25	38,4	46,5	16,0	3/4"
32 x 1"	pcs	40	5	0,22	0,60	AA222032001	BA222032001	WA222032001	32	48,4	58,0	18,1	1"

FV PPR tee with metal male thread

System: **FV AQUA**
 Material: PPR - brass
 Standard: ČSN EN ISO 15874, DIN 8077, DIN 8078
 Details: Transition fitting from plastic part to metal part of pipeline.

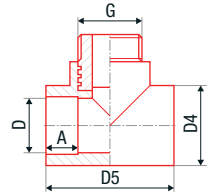

Objekt	Symbol	Skupina	Podskupina	Objem	Objem	# ●	# ●	# ●	D [mm]	D4 [mm]	D5 [mm]	A [mm]	G [mm]
20 x 1/2"	pcs	100	10	0,09	0,19	AA254020012	BA254020012	WA254020012	20	29,2	36,8	14,5	1/2"
25 x 1/2"	pcs	40	10	0,10	0,24	AA254025012	BA254025012	WA254025012	25	37,0	41,0	16,0	1/2"
25 x 3/4"	pcs	30	10	0,17	0,32	AA254025034	BA254025034	WA254025034	32	37,0	41,0	16,0	3/4"

FV PPR metal reducer with cap nut

System: **FV AQUA**
 Material: PPR - brass
 Standard: ČSN EN ISO 15874, DIN 8077, DIN 8078
 Details: Transition fitting from plastic part to metal part of pipeline.

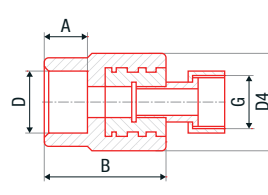

Objekt	Symbol	Skupina	Podskupina	Objem	Objem	# ●	# ●	# ●	D [mm]	D4 [mm]	A [mm]	B [mm]	G [mm]
16 x 1/2"	pcs	120	10	0,05	0,05	AA223016012	BA223016012	WA223016012	16	37	13,3	33,6	1/2"
16 x 3/4"	pcs	100	10	0,08	0,06	AA223016034	BA223016034	WA223016034	16	37	13,3	37,0	3/4"
20 x 1/2"	pcs	120	10	0,05	0,05	AA223020012	BA223020012	WA223020012	20	37	14,5	33,6	1/2"
20 x 3/4"	pcs	100	10	0,08	0,06	AA223020034	BA223020034	WA223020034	20	37	14,5	37,0	3/4"
20 x 1"	pcs	50	10	0,23	0,06	AA223020044	BA223020044	WA223020044	20	43	14,5	43,0	1"
25 x 3/4"	pcs	100	10	0,26	0,06	AA223025034	BA223025034	WA223025034	25	37	16,0	39,0	3/4"
25 x 1"	pcs	40	10	0,26	0,07	AA223025044	BA223025044	WA223025044	25	43	16,0	44,0	1"
32 x 5/4"	pcs	25	5	0,38	0,12	AA223032054	BA223032054	WA223032054	32	52	18,1	47,5	5/4"

FV PPR union plastic / brass unwelded

System: **FV AQUA**
 Material: PPR - brass
 Standard: ČSN EN ISO 15874, DIN 8077, DIN 8078
 Details: Transition fitting from plastic part to metal part of pipeline. | * with a hole for seal

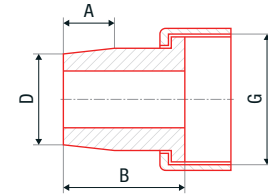

Objekt	Symbol	Skupina	Podskupina	Objem	Objem	# ●	# ●	# ●	D [mm]	A [mm]	B [mm]	G [mm]
20 x 3/4"	pcs	150	50	0,04	0,05	AA225020034	BA225020034	WA225020034	20	14,5	35,5	3/4"
25 x 1"	pcs	80	20	0,07	0,10	AA225025001	BA225025001	WA225025001	25	16,0	45,2	1"
32 x 5/4"	pcs	45	15	0,10	0,18	AA225032054	BA225032054	WA225032054	32	18,0	45,3	5/4"
40 x 6/4"	pcs	40	1	0,16	0,22	AA225040064	BA225040064	WA225040064	40	20,5	51,5	6/4"
50 x 2"	pcs	20	1	0,30	0,41	AA225050002	BA225050002	WA225050002	50	23,5	60,5	2"
* 20 x 3/4"	pcs	150	50	0,04	0,05	AA225020134	BA225020134	WA225020134	20	14,8	35,5	3/4"

FV PPR plastic reducing sleeve with cap nut

System: **FV AQUA**
 Material: PPR - brass
 Standard: ČSN EN ISO 15874, DIN 8077, DIN 8078
 Details: Transition fitting from plastic part to metal part of pipeline | * with a hole for seal

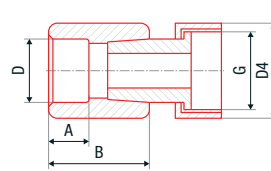

Q _{lin}	⊕	⊞	⊞	🔒	dm ³	# ●	# ●	# ●	D [mm]	D4 [mm]	A [mm]	B [mm]	G [mm]
16 × 3/4"	pcs	220	20	0,05	0,16	AA226016034	BA226016034	WA226016034	16	29,2	13,0	33,1	3/4"
20 × 1/2"	pcs	300	25	0,04	0,16	AA226020012	BA226020012	WA226020012	20	29,2	14,5	34,0	1/2"
20 × 3/4"	pcs	200	20	0,05	0,16	AA226020034	BA226020034	WA226020034	20	28,6	14,5	32,4	3/4"
25 × 3/4"	pcs	150	10	0,05	0,19	AA226025034	BA226025034	WA226025034	25	36,8	16,0	34,4	3/4"
25 × 1"	pcs	120	10	0,09	0,19	AA226025044	BA226025044	WA226025044	25	36,7	16,0	35,0	1"
32 × 1"	pcs	100	10	0,10	0,48	AA226032044	BA226032044	WA226032044	32	47,0	18,0	38,0	1"
* 20 × 3/4"	pcs	200	20	0,05	0,16	AA226020134	BA226020134	WA226020134	20	28,6	14,5	32,0	3/4"
* 25 × 3/4"	pcs	150	10	0,05	0,19	AA226025134	BA226025134	WA226025134	32	36,8	16,0	34,0	3/4"

FV PPR coupling with nut

System: **FV AQUA**
 Material: PPR - brass
 Standard: ČSN EN ISO 15874, DIN 8077, DIN 8078
 Details: Mountable and demountable joint.

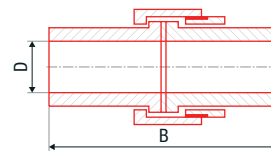

Q _{lin}	⊕	⊞	⊞	🔒	dm ³	# ●	# ●	# ●	D [mm]	B [mm]
20	pcs	200	10	0,08	0,15	AA224020000	BA224020000	WA224020000	20	73,0
25	pcs	120	5	0,12	0,20	AA224025000	BA224025000	WA224025000	25	93,5
32	pcs	70	5	0,19	0,25	AA224032000	BA224032000	WA224032000	32	93,5
40	pcs	50	5	0,27	0,35	AA224040000	BA224040000	WA224040000	40	105,0
50	pcs	25	5	0,49	0,65	AA224050000	BA224050000	WA224050000	50	123,0

FV PPR elbow 90° plastic reducing sleeve with cap nut

System: **FV AQUA**
 Material: PPR - brass
 Standard: ČSN EN ISO 15874, DIN 8077, DIN 8078
 Details: Transition fitting from plastic part to metal part of pipeline | * with a hole for seal

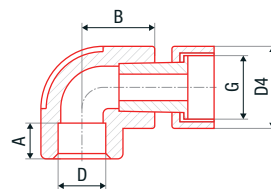

Q _{lin}	⊕	⊞	⊞	🔒	dm ³	# ●	# ●	# ●	D [mm]	D4 [mm]	A [mm]	B [mm]	G [mm]
20 × 1/2"	pcs	250	25	0,04	0,02	AA227020012	BA227020012	WA227020012	20	29,0	14,5	29,3	1/2"
20 × 3/4"	pcs	180	20	0,06	0,03	AA227020034	BA227020034	WA227020034	25	30,0	14,5	25,5	3/4"
25 × 3/4"	pcs	120	10	0,06	0,10	AA227025034	BA227025034	WA227025034	32	36,6	16,0	32,0	3/4"
* 20 × 3/4"	pcs	180	20	0,06	0,02	AA227020134	BA227020134	WA227020134	20	30,0	14,5	25,5	3/4"

FV PPR tee plastic reducing sleeve with cap nut

System: **FV AQUA**
 Material: PPR - brass
 Standard: ČSN EN ISO 15874, DIN 8077, DIN 8078
 Details: Transition fitting from plastic part to metal part of pipeline | * with a hole for seal

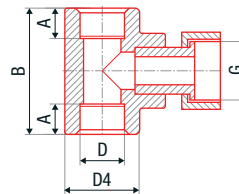

Q _{lin}	⊕	⊞	⊞	🔒	dm ³	# ●	# ●	# ●	D [mm]	D4 [mm]	A [mm]	B [mm]	G [mm]
20 × 3/4" × 20	pcs	130	10	0,07	0,24	AA228020034	BA228020034	WA228020034	20	29,0	14,5	51,0	3/4"
25 × 3/4" × 25	pcs	80	10	0,08	0,32	AA228025034	BA228025034	WA228025034	25	36,6	16,0	58,0	3/4"
32 × 3/4" × 32	pcs	60	10	0,11	0,38	AA228032034	BA228032034	WA228032034	32	46,0	18,1	61,4	3/4"
32 × 1" × 32	pcs	50	10	0,13	0,38	AA228032044	BA228032044	WA228032044	32	45,6	18,1	69,0	1"
* 20 × 3/4" × 20	pcs	120	20	0,07	0,24	AA228020134	BA228020134	WA228020134	20	29,0	14,5	51,0	3/4"
* 25 × 3/4" × 25	pcs	80	10	0,08	0,32	AA228025134	BA228025134	WA228025134	25	36,6	16,0	58,0	3/4"

FV PPR flange adaptor

System: **FV AQUA**
 Material: PPR
 Standard: ČSN EN ISO 15874, DIN 8077, DIN 8078
 Details: Plastic fitting for flange dismountable joints.

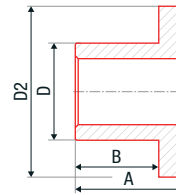

Code	Unit	Q1	Q2	Weight	dm³	# ●	# ●	# ●	D [mm]	D2 [mm]	A [mm]	B [mm]
40/32	pcs	40	4	0,07	0,35	AA230040032	BA230040032	WA230040032	40	78	50	38,0
50/40	pcs	40	2	0,10	0,55	AA230050040	BA230050040	WA230050040	50	98	55	43,0
63/50	pcs	20	2	0,15	0,67	AA230063050	BA230063050	WA230063050	60	112	60	46,5
75/65	pcs	15	1	0,26	1,20	AA230075065	BA230075065	WA230075065	75	122	66	50,0
90/80	pcs	10	1	0,37	1,35	AA230090080	BA230090080	WA230090080	90	135	82	63,0
110/100	pcs	5	1	0,62	2,45	AA230110100	BA230110100	WA230110100	110	163	100	82,0
125/100	pcs	1	1	0,36	2,34		BA230125100		125	162	53	40,0
125/125	pcs	1	1	1,34	5,38		BA230125125		125	188	185	145

FV PPR FE flange

System: **FV AQUA**
 Material: cast-iron
 Standard: ČSN EN ISO 15874, DIN 8077, DIN 8078
 Details: Metal fitting for flange dismountable joints.

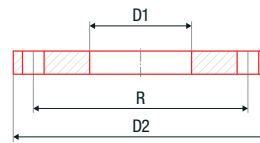

Code	Unit	Q1	Q2	Weight	dm³	# ●	# ●	# ●	D1 [mm]	D2 [mm]	R [mm]	d	no. of holes
40/32	pcs	1	1	1,42	0,35	AA231040032			43	140	100	M 16	4
50/40	pcs	1	1	1,82	0,38	AA231050040			53	150	110	M 16	4
63/50	pcs	1	1	2,23	0,45	AA231063050			66	165	125	M 16	4
75/65	pcs	1	1	2,48	0,55	AA231075065			78	185	145	M 16	4
90/80	pcs	1	1	3,25	0,80	AA231090080			95	200	160	M 16	8
110/100	pcs	1	1	3,60	0,97	AA231110100			114	220	180	M 16	8
125/100	pcs	1	1	1,078	0,68	AA231125100			149	220	180	M 16	8
125/125	pcs	1	1	1,844	1,18	AA231125125			158	250	210	M 16	8

FV PPR transition union male

System: **FV AQUA**
 Material: PPR - brass
 Standard: ČSN EN ISO 15874, DIN 8077, DIN 8078
 Details: Transition demountable fitting from plastic part to metal part of pipeline.

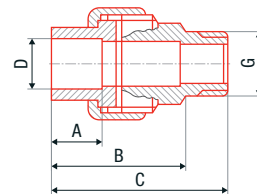

Code	Unit	Q1	Q2	Weight	dm³	# ●	# ●	# ●	D [mm]	A [mm]	B [mm]	C [mm]	G [mm]
20 × 1/2"	pcs	125	1	0,11	0,09	AA237020012	BA237020012	WA237020012	20	14,5	41	53	1/2"
25 × 3/4"	pcs	65	1	0,19	0,17	AA237025034	BA237025034	WA237025034	25	16,0	44	59	3/4"
32 × 1"	pcs	50	1	0,25	0,22	AA237032001	BA237032001	WA237032001	32	18,1	46	63	1"
40 × 5/4"	pcs	25	1	0,36	0,44	AA237040054	BA237040054	WA237040054	40	20,5	51	68	5/4"
50 × 6/4"	pcs	20	1	0,59	0,55	AA237050064	BA237050064	WA237050064	50	23,5	52	70	6/4"
63 × 2"	pcs	8	1	1,03	1,37	AA237063002	BA237063002	WA237063002	63	27,4	64	90	2"

FV PPR transition union female

System: **FV AQUA**
 Material: PPR - brass
 Standard: ČSN EN ISO 15874, DIN 8077, DIN 8078
 Details: Transition demountable fitting from plastic part to metal part of pipeline.

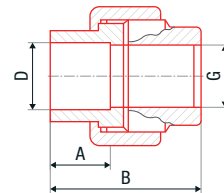

Code	Unit	Q1	Q2	Weight	dm³	# ●	# ●	# ●	D [mm]	A [mm]	B [mm]	G [mm]
20 × 1/2"	pcs	150	1	0,10	0,07	AA236020012	BA236020012	WA236020012	20	14,5	41	1/2"
25 × 3/4"	pcs	75	1	0,16	0,15	AA236025034	BA236025034	WA236025034	25	16,0	44	3/4"
32 × 1"	pcs	50	1	0,19	0,22	AA236032001	BA236032001	WA236032001	32	18,1	46	1"
40 × 5/4"	pcs	30	1	0,32	0,36	AA236040054	BA236040054	WA236040054	40	20,5	51	5/4"
50 × 6/4"	pcs	25	1	0,48	0,55	AA236050064	BA236050064	WA236050064	50	23,5	52	6/4"
63 × 2"	pcs	8	1	0,82	1,37	AA236063002	BA236063002	WA236063002	63	27,4	64	2"

FV PPR elbow 90° for wall mounting

System: **FV AQUA**

Material: PPR - brass

Standard: ČSN EN ISO 15874, DIN 8077, DIN 8078

Details: Fixing fitting with tap connector for mixers.

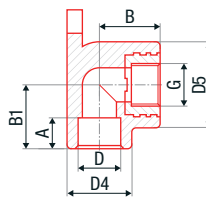

Icon	Symbol	Window	Grid	Weight	Volume	# ●	# ●	# ●	D [mm]	D4 [mm]	D5 [mm]	B [mm]	G [mm]
	pcs	50	10	0,07	0,22	AA219016012	BA219016012	WA219016012	16	38,6	28,2	35,0	1/2"
	pcs	100	10	0,07	0,36	AA219020012	BA219020012	WA219020012	20	39,6	30,2	34,3	1/2"
	pcs	30	10	0,12	0,55	AA219025034	BA219025034	WA219025034	25	46,4	37,2	40,0	1/2"
	pcs	30	10	0,13	1,37	AA219025012	BA219025012	WA219025012	25	46,4	37,2	40,0	3/4"

FV PPR elbow 90° for wall mounting intenal / external

System: **FV AQUA**

Material: PPR - brass

Standard: ČSN EN ISO 15874, DIN 8077, DIN 8078

Details: Fixing fitting with tap connector for mixers.

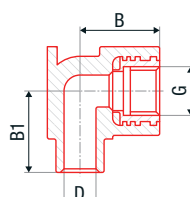

Icon	Symbol	Window	Grid	Weight	Volume	# ●	# ●	# ●	D [mm]	B [mm]	B1 [mm]	C [mm]	G [mm]
	pcs	100	10	0,06	0,21	AA239020012	BA239020012	WA239020012	20	35	35	11	1/2"

FV PPR wall mounting elbow with metal female thread LEFT and RIGHT

System: **FV AQUA**

Material: PPR - brass

Standard: ČSN EN ISO 15874, DIN 8077, DIN 8078

Details: Fixing fitting with tap connector for mixers.

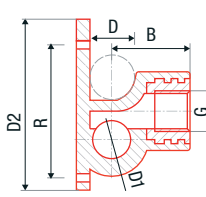

Icon	Symbol	Window	Grid	Weight	Volume	# ●	# ●	# ●	D [mm]	B [mm]	R [mm]	D2 [mm]	G [mm]
	pcs	100	10	0,078	0,216	AA219020013			20	34	62,1	74	1/2"
	pcs	100	10	0,078	0,216	AA219020014			20	34	62,1	74	1/2"

FV PPR elbow with metal female thread UNI

System: **FV AQUA**

Material: PPR - brass

Standard: ČSN EN ISO 15874, DIN 8077, DIN 8078

Details: Fixing fitting with tap connector for mixers.

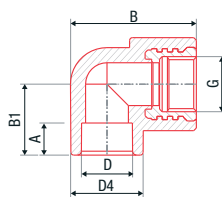

Icon	Symbol	Window	Grid	Weight	Volume	# ●	# ●	# ●	D [mm]	B [mm]	B1 [mm]	C [mm]	G [mm]
	pcs	120	10	0,06	0,15	AA258020012	BA258020012	WA258020012	20	35	29,8	14,5	1/2"

FV PPR holder MONO for UNI elbow

System: **FV AQUA**

Material: PPR

Standard: ČSN EN ISO 15874, DIN 8077, DIN 8078

Details: Fixing fitting with tap connector for mixers.

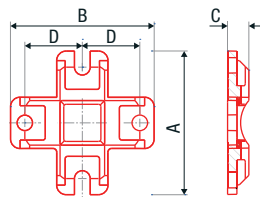

Icon	Symbol	Window	Grid	Weight	Volume	# ●	# ●	# ●	D [mm]	B [mm]	A [mm]	C [mm]
	pcs	200	1	0,008	0,036	AA258800000			24	60	60	8,9

FV PPR holder DUO for UNI elbow

System: **FV AQUA**
 Material: PPR - brass
 Standard: ČSN EN ISO 15874, DIN 8077, DIN 8078
 Details: Fixing fitting with tap connector for mixers.

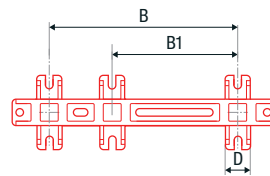

Icon	⊕	⊞	⊞	⊞	🔒	dm ³	# ●	# ●	# ●	D [mm]	B [mm]	B1 [mm]
20 x 1/2"	pcs	120	10	0,029	0,180	AA258900000				20	150	100

FV PPR wall elbows with holder

System: **FV AQUA**
 Material: PPR - brass
 Standard: ČSN EN ISO 15874, DIN 8077, DIN 8078
 Details: Tap water connector with adjustable distance of 100 or 150 mm.

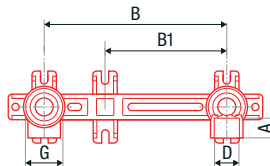

Icon	⊕	⊞	⊞	🔒	dm ³	# ●	# ●	# ●	D [mm]	A [mm]	B [mm]	B1 [mm]	G [mm]
20 x 1/2"	pcs	30	5	0,163	0,60	AA255020012	BA255020012	WA255020012	20	15	150	100	1/2"

FV PPR elbow for gypsum wall mounting

System: **FV AQUA**
 Material: PPR - brass
 Standard: ČSN EN ISO 15874, DIN 8077, DIN 8078
 Details: Fixing fitting with tap connector for mixers, for gypsum walls.

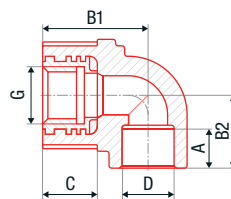

Icon	⊕	⊞	⊞	🔒	dm ³	# ●	# ●	# ●	D [mm]	A [mm]	B1, B2 [mm]	C [mm]	G [mm]
20 x 1/2"	pcs	50	1	0,13	1,02	AA240020012	BA240020012	WA240020012	20	15	42, 27	25	1/2"

FV PPR tee with tap connector

System: **FV AQUA**
 Material: PPR - brass
 Standard: ČSN EN ISO 15874, DIN 8077, DIN 8078
 Details: Fixing fitting with tap connector for mixers.

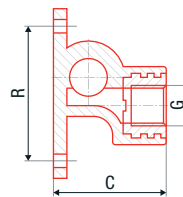

Icon	⊕	⊞	⊞	🔒	dm ³	# ●	# ●	# ●	D [mm]	A [mm]	C [mm]	R [mm]	G [mm]
20 x 1/2"	pcs	60	10	0,08	0,21	AA220020012	BA220020012	WA220020012	20	14,5	50	61,5	1/2"
25 x 1/2"	pcs	50	10	0,09	0,36	AA220025012	BA220025012	WA220025012	25	16,0	56	75,0	1/2"

FV PPR wall mounting group with tap connectors

System: **FV AQUA**
 Material: PPR - brass
 Standard: -
 Details: Tap water connectors with adjustable distance of 100 or 150mm.

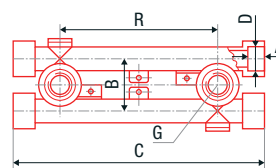

Icon	⊕	⊞	⊞	🔒	dm ³	# ●	# ●	# ●	D [mm]	A [mm]	B [mm]	C [mm]	G [mm]
2 x 20 x 1/2"	pcs	15	1	0,20	1,37	AA221020012	BA221020012	WA221020012	20	14,5	46	222	1/2"
2 x 25 x 1/2"	pcs	10	1	0,31	1,32	AA221025012	BA221025012	WA221025012	25	16,0	51	230	1/2"

FV PPR assembling plate for elbow 90° for wall mounting

System: **FV AQUA**

Material: PPR

Standard: -

Details: A practical accessory for an easy installation into dry building systems.

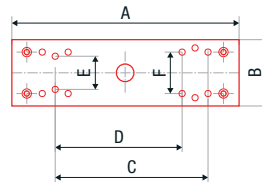

Icon	Unit	Quantity	Weight [kg]	Volume [dm³]	# ●	# ●	# ●	A [mm]	B [mm]	C [mm]	D [mm]	E, F [mm]	
	pcs	60	1	0,08	0,15	AA251000001			220	64	135	110	40, 45

FV PPR electro-fusion socket

System: **FV AQUA**

Material: PPR

Standard: -

Details: A fitting for pipe connection under electro-fusion welding condition.

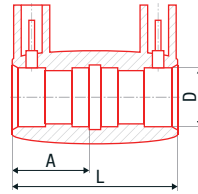

Icon	Unit	Quantity	Weight [kg]	Volume [dm³]	# ●	# ●	# ●	D [mm]	A [mm]	L [mm]
	pcs	1	1	0,03	0,02	AA234020000		20	26,5	55
	pcs	1	1	0,04	0,05	AA234025000		25	26,5	55
	pcs	1	1	0,05	0,10	AA234032000		32	25,0	52
	pcs	1	1	0,06	0,20	AA234040000		40	25,0	52
	pcs	1	1	0,08	0,30	AA234050000		50	25,0	52
	pcs	1	1	0,12	0,60	AA234063000		63	30,0	63
	pcs	1	1	0,16	0,90	AA234075000		75	33,0	70
	pcs	1	1	0,21	1,10	AA234090000		90	36,0	75
	pcs	1	1	0,36	1,80	AA234110000		110	40,0	87
	pcs	1	1	0,48	2,26		BA234125000	125	65,0	152,3

FV PPR joining elbow 45° to the radiator

System: **FV AQUA**

Material: PPR - brass

Standard: -

Details: For radiator connection.

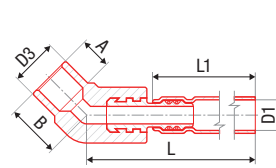

Icon	Unit	Quantity	Weight [kg]	Volume [dm³]	# ●	# ●	# ●	A [mm]	B [mm]	D1, D3 [mm]	L [mm]	L1 [mm]
	pcs	20	1	0,126			WA244020270	14,5	24	15, 20	300	270
	pcs	10	1	0,273			WA244020720	14,5	24	15, 20	750	720

FV PPR joining elbow 90° to the radiator

System: **FV AQUA**

Material: PPR - brass

Standard: -

Details: For radiator connection.

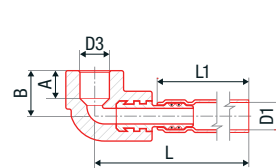

Icon	Unit	Quantity	Weight [kg]	Volume [dm³]	# ●	# ●	# ●	A [mm]	B [mm]	D1, D3 [mm]	L [mm]	L1 [mm]
	pcs	20	1	0,123			WA243020270	13	22,5	15, 20	298	270
	pcs	10	1	0,270			WA243020720	13	22,5	15, 20	748	720

FV PPR sleeve euroconus with metal thread

System: **FV AQUA**

Material: PPR - brass

Standard: -

Details: Transition fitting for radiator connection.

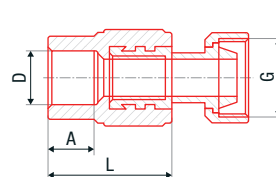

Icon	Unit	Quantity	Weight [kg]	Volume [dm³]	# ●	# ●	# ●	D [mm]	A [mm]	G [mm]	L [mm]
	pcs	100	10	0,091	0,154	AA257020034		20	14,5	3/4"	40

CLOSING FITTINGS

FV PPR ball valve plastic with a butterfly FV PPR ball valve plastic with a lever

System: **FV AQUA**
 Material: PPR - brass
 Standard: ČSN EN ISO 15874, DIN 8077, DIN 8078
 Details: A ball cock with a chromed ball and teflon seals.

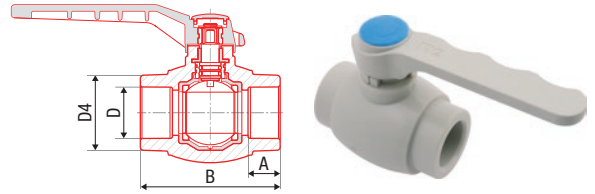

DN	Symbol	Quantity	Weight	Volume	Flow	Material	Color	Handle	Material	D [mm]	D4 [mm]	A [mm]	B [mm]
16	pcs	40	10	0,12	0,17	AA271016000	BA271016000	WA271016000	with a butterfly	16	22,8	13,0	58,6
20	pcs	40	10	0,12	0,34	AA271020000	BA271020000	WA271020000	with a butterfly	20	31,2	14,5	61,1
20	pcs	40	10	0,12	0,34	AA271020100	BA271020100	WA271020100	with a lever	20	31,2	14,5	61,1
25	pcs	40	4	0,21	0,69	AA271025000	BA271025000	WA271025000	with a lever	25	37,4	16,0	74,5
32	pcs	20	2	0,36	0,69	AA271032000	BA271032000	WA271032000	with a lever	32	48,5	18,0	85,0
40	pcs	15	1	0,36	1,60	AA271040000	BA271040000	WA271040000	with a lever	40	60,4	20,5	98,0
50	pcs	9	1	0,65	1,60	AA271050000	BA271050000	WA271050000	with a lever	50	75,0	23,5	116,3
63	pcs	6	1	1,12	4,80	AA271063000	BA271063000	WA271063000	with a lever	63	92,5	27,5	131,0
75	pcs	4	1	1,83	4,80	AA271075000	BA271075000	WA271075000	with a lever	75	108,0	30,0	165,0

FV PPR ball valve plastic with PV valve

System: **FV AQUA**
 Material: PPR - brass
 Standard: ČSN EN ISO 15874, DIN 8077, DIN 8078
 Details: A ball cock with a chromed ball and teflon seals.
 see note* page 40

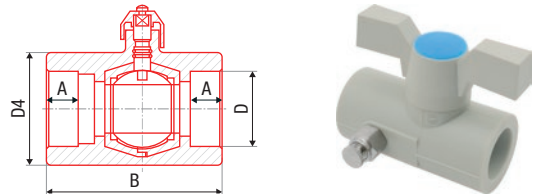

DN	Symbol	Quantity	Weight	Volume	Flow	Material	Color	Handle	Material	D [mm]	D4 [mm]	A [mm]	B [mm]
20	pcs	60	10	0,14	0,37	AA272020000	BA272020000	WA272020000		20	31,4	14,5	74,5
25	pcs	60	10	0,14	0,40	AA272025000	BA272025000	WA272025000		25	38,2	16,0	78,5
32	pcs	30	2	0,24	0,80	AA272032000	BA272032000	WA272032000		32	49,0	18,0	91,0
40	pcs	20	2	0,38	1,60	AA272040000	BA272040000	WA272040000		40	60,0	20,5	105,0
50	pcs	18	1	0,66	1,60	AA272050000	BA272050000	WA272050000		50	76,0	23,5	121,5
63	pcs	8	1	1,14	4,80	AA272063000	BA272063000	WA272063000		63	94,0	27,5	144,0
75	pcs	5	1	1,85	4,80	AA272075000	BA272075000	WA272075000		75	108,0	30,0	165,0

FV PPR radiator ball valve straight

System: **FV AQUA**
 Material: PPR - brass
 Standard: ČSN EN ISO 15874, DIN 8077, DIN 8078
 Details: A ball cock with a chromed ball and teflon seals.

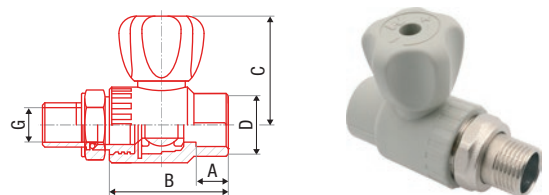

DN	Symbol	Quantity	Weight	Volume	Flow	Material	Color	Handle	Material	D [mm]	D4 [mm]	A [mm]	B [mm]	C [mm]
20 × 1/2"	pcs	60	1	0,154	0,12	AA289020000		WA289020000		20	29	16,1	55,1	52
25 × 3/4"	pcs	40	1	0,198	0,16	AA289025000		WA289025000		25	36,5	17,1	60,2	56

FV PPR radiator ball valve elbow

System: **FV AQUA**
 Material: PPR - brass
 Standard: ČSN EN ISO 15874, DIN 8077, DIN 8078
 Details: A ball cock with a chromed ball and teflon seals.

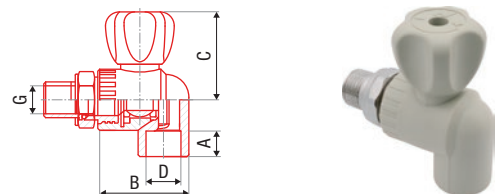

DN	Symbol	Quantity	Weight	Volume	Flow	Material	Color	Handle	Material	D [mm]	D4 [mm]	A [mm]	B [mm]	C [mm]
20 × 1/2"	pcs	50	1	0,160	0,13	AA290020000		WA290020000		20	29,0	15,1	51,0	52
25 × 3/4"	pcs	40	1	0,198	0,18	AA290025000		WA290025000		25	36,5	17,1	60,5	56

FV PPR ball valve with threaded elbow for hose connection

System: **FV AQUA**
 Material: PPR - brass
 Standard: ČSN EN ISO 15874, DIN 8077, DIN 8078
 Details: A plastic tap for garden purposes.

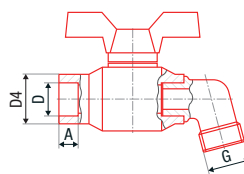

Icon	⊕	⊞	⊞	⊞	⊞	# ●	# ●	# ●	D [mm]	D4 [mm]	A [mm]	B [mm]	G [mm]
20	pcs	40	1	0,14	0,39	AA273020000	BA273020000	WA273020000	20	31,2	14,5	96	3/4"
25	pcs	30	1	0,15	0,77	AA273025000	BA273025000	WA273025000	25	37,4	16,0	117	1"

FV PPR valve with threaded elbow for hose connection

System: **FV AQUA**
 Material: PPR - brass
 Standard: ČSN EN ISO 15874, DIN 8077, DIN 8078
 Details: A plastic tap for garden purposes.

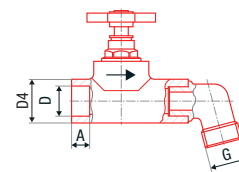

Icon	⊕	⊞	⊞	⊞	⊞	# ●	# ●	# ●	D [mm]	D4 [mm]	A [mm]	B [mm]	G [mm]
20	pcs	50	10	0,17	0,65	AA276020000	BA276020000	WA276020000	20	30,0	14,5	112,5	3/4"
25	pcs	40	10	0,24	0,68	AA276025000	BA276025000	WA276025000	25	37,3	16,0	125,0	1"

FV PPR straight-way valve

System: **FV AQUA**
 Material: PPR - brass
 Standard: ČSN EN ISO 15874, DIN 8077, DIN 8078
 Details: A valve allowing closing or regulation of the flow of water.

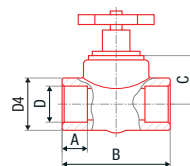

Icon	⊕	⊞	⊞	⊞	⊞	# ●	# ●	# ●	D [mm]	D4 [mm]	A [mm]	B [mm]	C [mm]
20	pcs	60	10	0,15	0,60	AA274020000	BA274020000	WA274020000	20	30	14,5	76,0	26
25	pcs	40	10	0,21	0,60	AA274025000	BA274025000	WA274025000	25	37	16,0	83,5	35
32	pcs	35	5	0,32	0,96	AA274032000	BA274032000	WA274032000	32	46	18,0	94,0	38
40	pcs	20	2	0,40	1,07	AA274040000	BA274040000	WA274040000	40	60	20,5	107,0	38
50	pcs	10	0	0,75	1,92	AA274050000	BA274050000	WA274050000	50	71	23,5	135,0	56
63	pcs	6	0	1,29	2,10	AA274063000	BA274063000	WA274063000	63	84	27,5	160,0	60

FV PPR straight-way valve with PV valve

System: **FV AQUA**
 Material: PPR - brass
 Standard: ČSN EN ISO 15874, DIN 8077, DIN 8078
 Details: A valve allowing closing or regulation of the flow of water.

see note* page 40

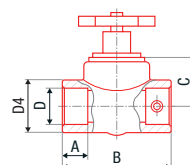

Icon	⊕	⊞	⊞	⊞	⊞	# ●	# ●	# ●	D [mm]	D4 [mm]	A [mm]	B [mm]	C [mm]
20	pcs	50	10	0,17	0,60	AA275020000	BA275020000	WA275020000	20	30	14,5	76,0	26
25	pcs	40	10	0,24	0,60	AA275025000	BA275025000	WA275025000	25	37	16,0	83,5	35
32	pcs	30	2	0,35	0,96	AA275032000	BA275032000	WA275032000	32	46	18,0	94,0	38
40	pcs	20	2	0,42	1,07	AA275040000	BA275040000	WA275040000	40	60	20,5	107,0	38

FV PPR angle straight-way valve

System: **FV AQUA**
 Material: PPR - brass
 Standard: ČSN EN ISO 15874, DIN 8077, DIN 8078
 Details: A valve allowing closing or regulation of the flow of water.

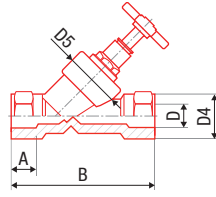

Icon	⊕	⊞	⊞	🔒	dm ³	# ●	# ●	# ●	D [mm]	D4 [mm]	D5 [mm]	A [mm]	B [mm]
20	pcs	50	1	0,19	0,25	AA277020000	BA277020000	WA277020000	20	35,3	46,8	14,5	83,6
25	pcs	40	1	0,16	0,56	AA277025000	BA277025000	WA277025000	25	35,3	46,8	16,0	83,6

FV PPR angle straight-way valve with PV valve

System: **FV AQUA**
 Material: PPR - brass
 Standard: ČSN EN ISO 15874, DIN 8077, DIN 8078
 Details: A valve allowing closing or regulation of the flow of water.

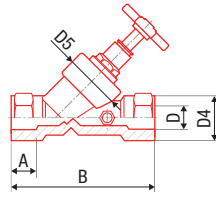

see note* page 40

Icon	⊕	⊞	⊞	🔒	dm ³	# ●	# ●	# ●	D [mm]	D4 [mm]	D5 [mm]	A [mm]	B [mm]
20	pcs	50	1	0,19	0,25	AA278020000	BA278020000	WA278020000	20	35,3	46,8	14,5	83,6
25	pcs	40	1	0,16	0,56	AA278025000	BA278025000	WA278025000	25	35,3	46,8	16,0	83,6

FV PPR angle straight-way valve with back flow

System: **FV AQUA**
 Material: PPR - brass
 Standard: ČSN EN ISO 15874, DIN 8077, DIN 8078
 Details: A valve allowing closing or regulation of the flow of water.

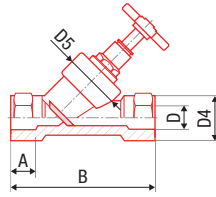

Icon	⊕	⊞	⊞	🔒	dm ³	# ●	# ●	# ●	D [mm]	D4 [mm]	D5 [mm]	A [mm]	B [mm]
20	pcs	50	1	0,19	0,25	AA279020000	BA279020000	WA279020000	20	35,3	46,8	14,5	83,6
25	pcs	40	1	0,16	0,56	AA279025000	BA279025000	WA279025000	25	35,3	46,8	16,0	83,6

FV PPR back flow valve

System: **FV AQUA**
 Material: PPR - brass
 Standard: ČSN EN ISO 15874, DIN 8077, DIN 8078
 Details: For prevention of back flow.

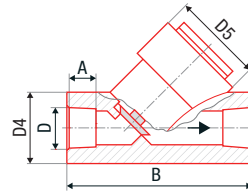

Icon	⊕	⊞	⊞	🔒	dm ³	# ●	# ●	# ●	D [mm]	D4 [mm]	D5 [mm]	A [mm]	B [mm]
20	pcs	40	1	0,19	0,25	AA281020000	BA281020000	WA281020000	20	35,3	46,8	14,5	83,6
25	pcs	40	1	0,19	0,25	AA281025000	BA281025000	WA281025000	25	35,3	46,8	16,0	83,6
32	pcs	40	1	0,16	0,56	AA281032000	BA281032000	WA281032000	32	42,0	46,8	18,0	94,0

Note: *The hexagonal valve at the valve body is a structural element that serves to lock and prevent reversing when the valve is released. Never turn the hexagon. To open the discharge valve, a manually operated perimeter cut-out screw is provided. Anticlockwise, the valve opens and closes clockwise.

FV PPR filter

System: **FV AQUA**
 Material: PPR - brass
 Standard: ČSN EN ISO 15874, DIN 8077, DIN 8078
 Details: Combined fitting with stainless strainer.

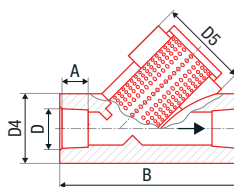

Icon	⊕	⊞	⊞	📦	dm ³	# ●	# ●	# ●	D [mm]	D4 [mm]	D5 [mm]	A [mm]	B [mm]
20	pcs	40	1	0,17	0,36	AA282020000	BA282020000	WA282020000	20	35,3	46,8	14,5	83,6
25	pcs	40	1	0,17	0,36	AA282025000	BA282025000	WA282025000	25	35,3	46,8	16,0	83,6
32	pcs	40	1	0,25	0,54	AA282032000	BA282032000	WA282032000	32	42,0	46,8	18,0	94,0

FV PPR shut off valve lux straight with chrome handle

System: **FV AQUA**
 Material: PPR - brass
 Standard: ČSN EN ISO 15874, DIN 8077, DIN 8078
 Details: An elegant above-plaster valve for closing branches of a distribution system.

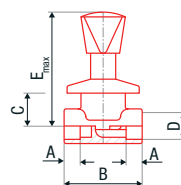

Icon	⊕	⊞	⊞	📦	dm ³	# ●	# ●	# ●	D, D4 [mm]	A [mm]	B [mm]	C [mm]	E_max [mm]
20	pcs	15	1	0,25		AA285020000	BA285020000	WA285020000	20/36	14,5	76,0	26	105
25	pcs	12	1	0,30		AA285025000	BA285025000	WA285025000	25/37,3	16,0	83,5	35	115

FV PPR shut off valve straight with cover

System: **FV AQUA**
 Material: PPR - brass
 Standard: ČSN EN ISO 15874, DIN 8077, DIN 8078
 Details: An elegant above-plaster valve for closing branches of a distribution system.

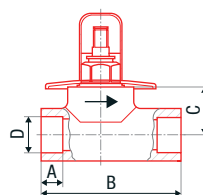

Icon	⊕	⊞	⊞	📦	dm ³	# ●	# ●	# ●	D [mm]	A [mm]	B [mm]	C [mm]	
20*	pcs	20	1	0,17		AA286020000	BA286020000	WA286020000	metal cover	20	15	75,6	26
20L*	pcs	20	1	0,17		AA286020100	BA286020100	WA286020100	metal cover	20	15	75,6	25
25	pcs	15	1	0,21		AA286025000	BA286025000	WA286025000	metal cover	25	16	83,3	36
25L	pcs	15	1	0,21		AA286056100	BA286056100	WA286056100	metal cover	25	16	83,3	35
20	pcs	20	1	0,17		AA287020000	BA287020000	WA287020000	plastic cover	20	15	75,6	26
20L	pcs	20	1	0,17		AA287020100	BA287020100	WA287020100	plastic cover	20	15	75,6	26
25	pcs	15	1	0,21		AA287025000	BA287025000	WA287025000	plastic cover	25	16	83,3	34
25L	pcs	15	1	0,21		AA287025100	BA287025100	WA287025100	plastic cover	25	16	83,3	36

FV PPR inside the valve

System: **FV AQUA**
 Material: PPR - brass
 Standard: ČSN EN ISO 15874, DIN 8077, DIN 8078
 Details: Spare part for straight-way valve.

Note: Spare parts for all type of straight-way valve and shut off valve. For order please contact our sales department.



Icon	⊕	⊞	⊞	📦	dm ³	#	D [mm]	description
20	pcs		1			AA288020001	20	short d32
20	pcs		1			AA288020002	20	long (laguna) d20
25	pcs		1			AA288025001	25	long (laguna) d20
25	pcs		1			AA288025002	25	short d32
32	pcs		1			AA288032001	32	short d32

FV PP-RCT FITTINGS FOR BUT WELDING

FV PP-RCT butt welding elbow 90°

System: **FV AQUA**
 Material: PP-RCT
 Standard: ČSN EN ISO 15874, DIN 8077, DIN 8078
 Details: A simple, reliable fitting for changing the pipeline direction.

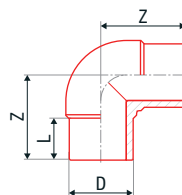

Code	Unit	Grid	Grid	Weight	Volume	#	D [mm]	Z [mm]	L [mm]
160	pcs		1	2,21	9	BA202160000	160	212	110
200	pcs		1	2,96	20	BA202200000	200	255	127
250	pcs		1	3,42	30	BA202250000	250	294	140

FV PP-RCT butt welding elbow 45°

System: **FV AQUA**
 Material: PP-RCT
 Standard: ČSN EN ISO 15874, DIN 8077, DIN 8078
 Details: A simple, reliable fitting for changing the pipeline direction.

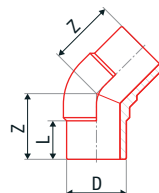

Code	Unit	Grid	Grid	Weight	Volume	#	D [mm]	Z [mm]	L [mm]
160	pcs		1	1,95	7	BA203160000	160	168	110
200	pcs		1	2,54	16	BA203200000	200	217	127
250	pcs		1	3,09	25	BA203250000	250	223	140

FV PP-RCT butt welding reduction

System: **FV AQUA**
 Material: PP-RCT
 Standard: ČSN EN ISO 15874, DIN 8077, DIN 8078
 Details: A simple, reliable fitting for dimension change of pipeline.

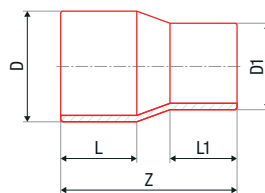

Code	Unit	Grid	Grid	Weight	Volume	#	D [mm]	D1 [mm]	Z [mm]	L [mm]	L1 [mm]
160 x 110	pcs		1	1,14	5	BA210160110	160	110	255	110	93
160 x 125	pcs		1	1,16	5	BA210160125	160	125	255	110	97
200 x 160	pcs		1	2,61	9	BA210200160	200	160	275	122	100
250 x 160	pcs		1	3,95	14	BA210250160	250	160	330	137	111
250 x 200	pcs		1	4,45	15	BA210250200	250	200	330	137	128

FV PP-RCT electro-fusion socket

System: **FV AQUA**
 Material: PP-RCT
 Standard: ČSN EN ISO 15874, DIN 8077, DIN 8078
 Details: A fitting for pipe connection under electro-fusion welding condition.

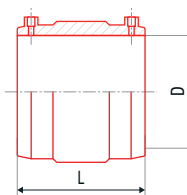

Code	Unit	Grid	Grid	Weight	Volume	#	D [mm]	L [mm]
160	pcs		1	1,82	5	BA234160000	160	175
200	pcs		1	2,58	9	BA234200000	200	185
250	pcs		1	4,42	14	BA234250000	250	213

FV PP-RCT butt welding tee

System: **FV AQUA**
 Material: PP-RCT
 Standard: ČSN EN ISO 15874, DIN 8077, DIN 8078
 Details: A simple, reliable fitting for branching the pipeline.

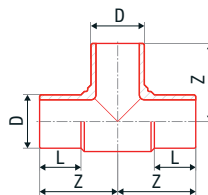

Objekt	Symbol	Skupina	Podskupina	Objem	Objem [dm ³]	#	D [mm]	Z [mm]	L [mm]
160	pcs		1	3,99	12	BA208160000	160	225	124
200	pcs		1	7,38	18	BA208200000	200	251	127
250	pcs		1	9,80	23	BA208250000	250	314	148

FV PP-RCT polyfusion/butt welding tee reduced

System: **FV AQUA**
 Material: PP-RCT
 Standard: ČSN EN ISO 15874, DIN 8077, DIN 8078
 Details: A simple, reliable fitting for branching the pipeline.

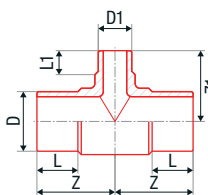

Objekt	Symbol	Skupina	Podskupina	Objem	Objem [dm ³]	#	D [mm]	D1 [mm]	Z [mm]	L [mm]	L1 [mm]
160 × 90 × 160	pcs		1	3,20	9	BA212160090	160	90	212	110	85
160 × 110 × 160	pcs		1	3,34	10	BA212160110	160	110	212	110	95
200 × 90 × 200	pcs		1	6,20	14	BA212200090	200	90	255	127	95
200 × 110 × 200	pcs		1	6,40	15	BA212200110	200	110	255	127	95
200 × 125 × 200	pcs		1	6,80	16	BA212200125	200	125	255	127	100
200 × 160 × 200	pcs		1	7,12	17	BA212200160	200	160	255	127	110

FV PP-RCT butt welding blinding

System: **FV AQUA**
 Material: PP-RCT
 Standard: ČSN EN ISO 15874, DIN 8077, DIN 8078
 Details: For permanent or temporary blinding of a branch.

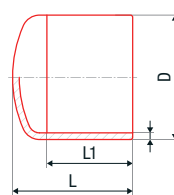

Objekt	Symbol	Skupina	Podskupina	Objem	Objem [dm ³]	#	D [mm]	L [mm]	L1 [mm]
160	pcs		1	0,90	2,9	BA229160000	160	140	100
200	pcs		1	2,03	6,2	BA229200000	200	190	145
250	pcs		1	3,18	12,7	BA229250000	250	218	263

FV PP-RCT weld in saddle polyfusion

System: **FV AQUA**
 Material: PP-RCT
 Standard: ČSN EN ISO 15874, DIN 8077, DIN 8078
 Details: For additional branches from existing pipeline.

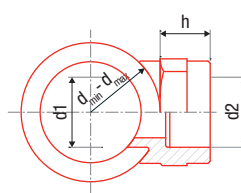

Objekt	Symbol	Skupina	Podskupina	Objem	Objem [dm ³]	#	d _{min} [mm]	d _{max} [mm]	d1 [mm]	d2 [mm]	h [mm]
125 × 32	pcs		1	0,04	0,4	BA238125032	75	125	32	32	35
125 × 40	pcs		1	0,04	0,4	BA238125040	75	125	40	40	38
125 × 50	pcs		1	0,04	0,4	BA238125050	110	125	50	50	39
125 × 63	pcs		1	0,04	0,4	BA238125063	125	125	63	63	45
160 - 250 × 20	pcs		1	0,04	0,4	BA238160020	160	250	20	20	29
160 - 250 × 25	pcs		1	0,04	0,4	BA238160025	160	250	25	25	29
160 - 250 × 32	pcs		1	0,04	0,4	BA238160032	160	250	32	32	35
160 - 250 × 40	pcs		1	0,04	0,4	BA238160040	160	250	40	40	38
160 - 250 × 50	pcs		1	0,04	0,4	BA238160050	160	250	50	50	39
160 - 250 × 63	pcs		1	0,04	0,4	BA238160063	160	125	63	63	45

FV PP-RCT weld in saddle with metal male thread polyfusion

System: **FV AQUA**
 Material: PP-RCT - brass
 Standard: ČSN EN ISO 15874, DIN 8077, DIN 8078
 Details: Transition fitting from plastic part to metal part of pipeline, for additional branches.

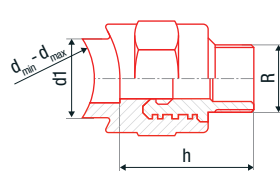

Objekt	Symbol	Material	Werkstoff	Werkstoff	Werkstoff	#	d _{min} [mm]	d _{max} [mm]	d1 [mm]	R [mm]	h [mm]
125 × 40 × 5/4"	pcs		1	0,08	0,4	BA248125040	75	125	40	1 1/4"	58
125 × 50 × 5/4"	pcs		1	0,08	0,4	BA248125050	90	125	50	1 1/4"	59
125 × 50 × 6/4"	pcs		1	0,08	0,4	BA248125051	110	125	50	1 1/2"	59
125 × 63 × 2"	pcs		1	0,08	0,4	BA248125063	125	125	63	2"	70
160 - 250 × 25 × 1/2"	pcs		1	0,08	0,4	BA248160020	160	250	25	1/2"	43
160 - 250 × 32 × 3/4"	pcs		1	0,08	0,4	BA248160025	160	250	32	3/4"	50
160 - 250 × 40 × 1"	pcs		1	0,08	0,4	BA248160032	160	250	40	1"	56
160 - 250 × 40 × 5/4"	pcs		1	0,08	0,4	BA248160040	160	250	40	1 1/4"	58
160 - 250 × 50 × 5/4"	pcs		1	0,08	0,4	BA248160050	160	250	50	1 1/4"	59
160 - 250 × 50 × 6/4"	pcs		1	0,08	0,4	BA248160051	160	250	50	1 1/2"	59
160 - 250 × 63 × 2"	pcs		1	0,08	0,4	BA248160063	160	250	63	2"	70

FV PP-RCT weld in saddle with metal female thread polyfusion

System: **FV AQUA**
 Material: PP-RCT - brass
 Standard: ČSN EN ISO 15874, DIN 8077, DIN 8078
 Details: Transition fitting from plastic part to metal part of pipeline, for additional branches.

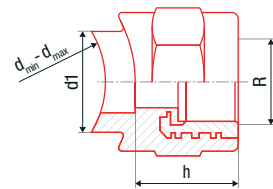

Objekt	Symbol	Material	Werkstoff	Werkstoff	Werkstoff	#	d _{min} [mm]	d _{max} [mm]	d [mm]	R [mm]	h [mm]
125 × 25 × 1/2"	pcs		1	0,07	0,4	BA247125025	75	125	25	1/2"	43
125 × 32 × 3/4"	pcs		1	0,07	0,4	BA247125032	75	125	32	3/4"	50
125 × 40 × 1"	pcs		1	0,07	0,4	BA247125040	75	125	40	1"	38
125 × 40 × 5/4"	pcs		1	0,07	0,4	BA247125041	75	125	40	1 1/4"	38
125 × 50 × 5/4"	pcs		1	0,07	0,4	BA247125050	90	125	50	1 1/4"	39
125 × 50 × 6/4"	pcs		1	0,07	0,4	BA247125051	110	125	50	1 1/2"	39
125 × 63 × 2"	pcs		1	0,07	0,4	BA247125063	125	125	63	2"	45
160 - 250 × 25 × 1/2"	pcs		1	0,07	0,4	BA247160025	160	250	25	1/2"	29
160 - 250 × 32 × 3/4"	pcs		1	0,07	0,4	BA247160032	160	250	32	3/4"	35
160 - 250 × 40 × 1"	pcs		1	0,07	0,4	BA247160040	160	250	40	1"	38
160 - 250 × 40 × 5/4"	pcs		1	0,07	0,4	BA247160041	160	250	40	1 1/4"	38
160 - 250 × 50 × 5/4"	pcs		1	0,07	0,4	BA247160050	160	250	50	1 1/4"	39
160 - 250 × 50 × 6/4"	pcs		1	0,07	0,4	BA247160051	160	250	50	1 1/2"	39
160 - 250 × 63 × 2"	pcs		1	0,07	0,4	BA247160063	160	250	63	2"	45

FV PP-RCT butt welding flange adaptor

System: **FV AQUA**
 Material: PP-RCT
 Standard: ČSN EN ISO 15874, DIN 8077, DIN 8078
 Details: Plastic fitting for flange dismountable joints.

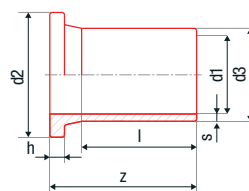

Objekt	Symbol	Material	Werkstoff	Werkstoff	Werkstoff	#	d1 [mm]	l [mm]	z [mm]	d2 [mm]	d3 [mm]	h [mm]	s [mm]
160/150	pcs		1	1,2	3,8	BA230160000	160	110	182	212	175	25	14,6
200/200	pcs		1	1,89	4,7	BA230200000	200	127	205	268	232	32	18,2
250/250	pcs		1	2,67	5,8	BA230250000	250	146	235	320	285	35	20,5

FV PP-RCT flange

System: **FV AQUA**
 Material: PP coated steel
 Standard: ČSN EN ISO 15874, DIN 8077, DIN 8078
 Details: Metal fitting for flange dismountable joints.

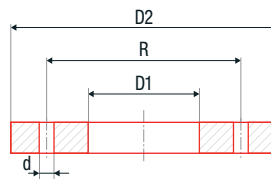

							#	D1 [mm]	D2 [mm]	R [mm]	d	number of holes
160	pcs		1	3,1	1,0		BA231160000	178	285	240	M16	8
200	pcs		1	4,6	1,2		BA231200000	235	340	295	M16	8
250	pcs		1	6	1,7		BA231250000	288	406	350	M16	12

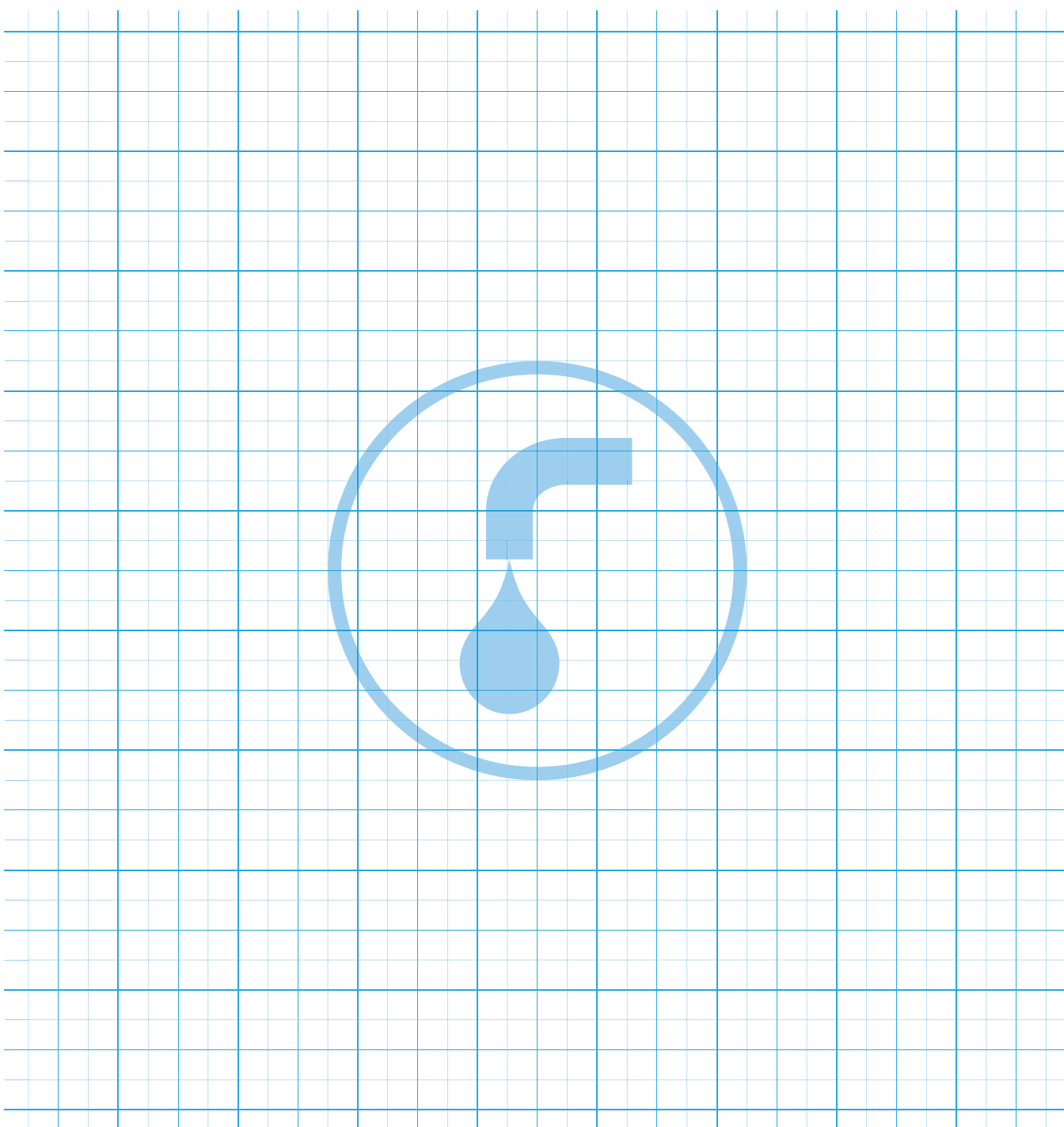



FV SM 21



FV SM 41

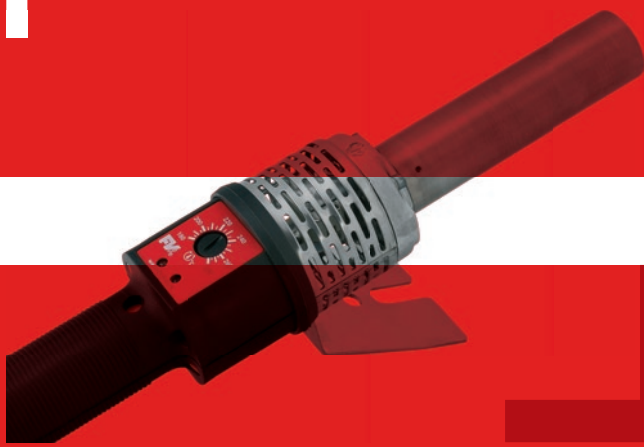

FV SE 21

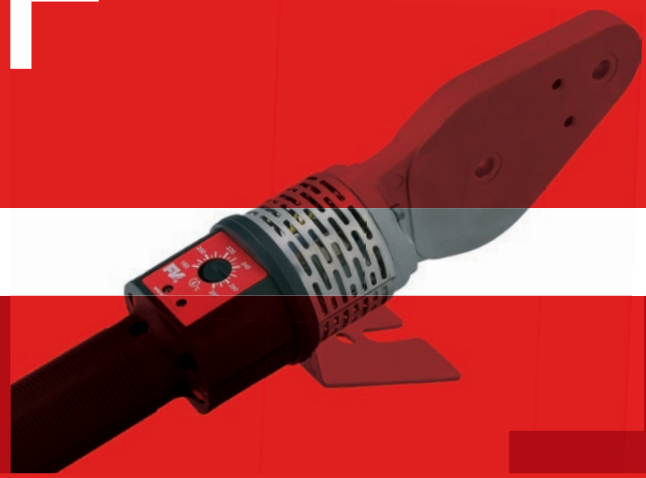

FV SE 41

TOOLS SUITABLE FOR FV AQUA PPR

Welding machine 650 W for non-paired adapter $\varnothing 16 - \varnothing 63$

Welding machine for non-paired adapter, manual adjustment (SM21), electronics adjustment (SE21)
The most favourite welding machine developed by FV-Plast, a.s., especially the model SM21 with direct control. Offered also as a set with a case.

						#	P [W]	
SM 21	pcs	1	1	1,28	6,14	AA401001650	650	thermostat
SE 21	pcs	1	1	1,28	6,14	AA401002650	650	electronic regulation



Welding machine 850 W for paired adapter $\varnothing 16 - \varnothing 75$

New generation of welding machine for paired adapter, manual adjustment (SM41), electronics adj. (SE41).
An efficient welding machine developed by FV-Plast, a.s. Quality workmanship, quality components, professional design, including durable power cord. The SE41 is equipped with precise electronic regulation. Suitable for welding of larger pipe diameters, fast heat up time.

						#	P [W]	
SM 41	pcs	1	1	1,32	6,14	AA402001850	850	thermostat
SE 41	pcs	1	1	1,32	6,14	AA402002850	850	electronic regulation



Dytron Welder Polys P-4 650 W

A welding machine by a renowned Czech producer.

						#	P [W]	
P-4a	pcs	1	1	1,60	6,21	AA403001650	650	thermostat
P-4b	pcs	1	1	2,00	6,21	AA403002650	650	electronic regulation



Dytron Welder Polys P-4 850 W

A welding machine by a renowned Czech producer.

						#	P [W]	
P-4a	pcs	1	1	2,00	6,21	AA404001850	850	electronic regulation



Dytron Welder Polys P-4 1200 W

A welding machine by a renowned Czech producer.

						#	P [W]	
P-4a	pcs	1	1	2,10	6,21	AA405001120	1200	electronic regulation



Dytron Welder Polys P-1b 500 W

A welding machine by a renowned Czech producer, suitable also for welding in installation shafts.



P-1b	pcs	1	1	1,58	63,00	AA406001500	500	thermostat

Mini set SM 21 M

Practical set for socket welding designed for hobbyists and unpretentious Professionals. Traditional metal case please durability and welder his life. Contents: thorns welder SM 21, jaw adaptors ø 20, 25 and 32 mm, metal case MINI, scissors, stand, 4 mm Allen key.



SM 21 M	set	1	1	5,12	8,52	AA407000000	650	thermostat



Mini set SM 41 M

Practical set for socket welding designed for hobbyists and unpretentious Professionals. Traditional metal case please durability and welder his life. Contents: flat welder SM 41, jaw adaptors ø 20, 25, 32 and 40 mm, metal case MINI, scissors, stand, 6 mm Allen key.



SM 41 M	set	1	1	5,40	8,52	AA408000000	850	thermostat



Profi set SE 21 P

Practical professional set for socket welding designed for all-day use in the most demanding craftsmen. Robust metal suitcase please durability and welder his life. Contents: 21 SE thorns welder, jaw adaptors ø 16, 20, 25, 32, 40, 50, 63 mm metal case PROFI, foot stand, scissors DYNO, 4 mm Allen key.



SE 21 P	set	1	1	8,26	16,58	AA409000000	650	electronic regulation



Profi set SE 41 P

Practical professional set for socket welding designed for all-day use in the most demanding craftsmen. Robust metal case please durability and welder his life. Contents: 41 SE thorns welder, jaw adaptors ø 16, 20, 25, 32, 40, 50, 63 mm metal case PROFI, foot stand, scissors DYNO, 6 mm Allen key.



SE 41 P	set	1	1	8,30	16,58	AA410000000	850	electronic regulation



Adapter paired for SM 41 and SE 41 black

Pair adapter can only be used for flat welder. Allow welding of pipes from the lowest d16 to the diameter d125. Depending on the size can be fitted to the welder suddenly one to two adapters.

DN	set	1	1	kg	dm ³	#
16	set	1	1	0,06	0,03	AA411016000
20	set	1	1	0,06	0,03	AA411020000
25	set	1	1	0,10	0,06	AA411025000
32	set	1	1	0,18	0,10	AA411032000
40	set	1	1	0,23	0,14	AA411040000
50	set	1	1	0,34	0,20	AA411050000
63	set	1	1	0,63	0,32	AA411063000
75	set	1	1	0,84	0,45	AA411075000
90	set	1	1	1,52	0,73	AA411090000
110	set	1	1	1,70	1,69	AA411110000
125	set	1	1	1,92	2,13	AA411110000



Adapter paired for SM 41 and SE 41 blue

Pair adapter can only be used for flat welder. Allow welding of pipes from the lowest d 20 to the diameter d110. Depending on the size can be fitted to the welder suddenly one to two adapters.

DN	set	1	1	kg	dm ³	#
20	set	1	1	0,06	0,03	AA411020001
25	set	1	1	0,10	0,06	AA411025001
32	set	1	1	0,18	0,10	AA411032001
40	set	1	1	0,23	0,14	AA411040001
50	set	1	1	0,34	0,20	AA411050001
63	set	1	1	0,63	0,32	AA411063001
75	set	1	1	0,84	0,45	AA411075001
90	set	1	1	1,52	0,73	AA411090001
110	set	1	1	1,70	1,69	AA411110001



Adapter paired for weld in saddle

Pair adapters can only be used for flat welder. Allow welding additional seats branches from d20 to pipe from d63 to d250. Depending on the size can be fitted to the welder suddenly one to two adapters.

DN	set	1	1	kg	dm ³	#
63 x 32	set	1	1	0,300	0,137	AA412063032
75 x 32	set	1	1	0,300	0,137	AA412075032
90 x 32	set	1	1	0,300	0,137	AA412090032
110 x 32	set	1	1	0,300	0,137	AA412110032
110 x 40	set	1	1	0,300	0,137	AA412110040
75 - 125 x 25	set	1	1	0,280	0,655	AA412125025
75 - 125 x 32	set	1	1	0,410	0,655	AA412125032
75 - 125 x 40	set	1	1	0,360	0,655	AA412125040
75 - 125 x 50	set	1	1	0,710	0,655	AA412125050
75 - 125 x 63	set	1	1	1,164	2,639	AA412125050
160 - 250 x 25	set	1	1	0,170	0,160	AA412160025
160 - 250 x 32	set	1	1	0,230	0,160	AA412160032
160 - 250 x 40	set	1	1	0,360	0,160	AA412160040
160 - 250 x 50	set	1	1	0,650	0,160	AA412160050
160 - 250 x 63	set	1	1	1,040	0,160	AA412160063



Drill for weld in saddle

Special drill for perfect drilling of holes in the main pipe to mount weld-in saddles of all types. Necessary tools to create the correct hole.

DN	pcs	1	1	kg	dm ³	#
25	pcs	1	1	0,42	0,10	AA414025000
32	pcs	1	1	0,21	0,10	AA414032000
40	pcs	1	1	0,30	1,10	AA414040000
50	pcs	1	1	0,44	0,46	AA414050000
63	pcs	1	1	0,48	0,46	AA414063000

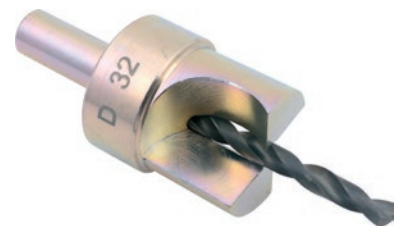

Adapter non-paired for SM 21 and SE 21 black

Jaw adapters can only be used for a rod type welders. Allow welding of pipes from the lowest diameters d16 to d63. Depending on the size can be fitted to the welder suddenly one to three extensions.

						#
16	pcs	1	1	0,13	0,13	AA415016000
20	pcs	1	1	0,15	0,15	AA415020000
25	pcs	1	1	0,16	0,19	AA415025000
32	pcs	1	1	0,17	0,30	AA415032000
40	pcs	1	1	0,30	0,41	AA415040000
50	pcs	1	1	0,40	0,57	AA415050000
63	pcs	1	1	0,77	0,85	AA415063000



Adapter non-paired for SM 21 and SE 21 blue

Jaw adapters can only be used for a rod type welders. Allow welding of pipes from the lowest diameters d16 to d63. Depending on the size can be fitted to the welder suddenly one to three extensions.

						#
16	pcs	1	1	0,13	0,13	AA415016001
20	pcs	1	1	0,11	0,15	AA415020001
25	pcs	1	1	0,14	0,19	AA415025001
32	pcs	1	1	0,22	0,30	AA415032001
40	pcs	1	1	0,325	0,41	AA415040001
50	pcs	1	1	0,480	0,57	AA415050001
63	pcs	1	1	0,725	0,85	AA415063001



Repairing set

A set for fast and reliable repairs of drill-damaged distribution systems. Allows easy repair pipes due to unintentional drilling without changing the pipe in the wall. Can only be used with a rod welders. Before use, inspect instructional video.

						#
	pcs	1	1	0,29		AA418000000



Repairing stake

Expendable supplies for a repair set.

						#
	set	1	5	0,07		AA419000000



STABIOXY pipes shaver

Essentially accurate, calibratable tool designed to remove the top layer of plastic and aluminum foil before welding pipes STABIOXY. Always two dimensions in a single instrument. Quality carbide blades. Before the first use, it is necessary to calibrate onto pipe PPR CLASSIC.

mm	pcs	mm	mm	mm	mm	#
16 - 20	pcs	1	1	0,15	0,19	AA420016020
20 - 25	pcs	1	1	0,19	0,19	AA420020025
25 - 32	pcs	1	1	0,23	0,25	AA420025032
32 - 40	pcs	1	1	0,24	0,30	AA420032040
50	pcs	1	1	0,20	0,30	AA420050000
63	pcs	1	1	0,30	0,42	AA420063000
75	pcs	1	1	0,34	0,57	AA420075000
90	pcs	1	1	0,66	0,91	AA420090000
110	pcs	1	1	0,72	1,33	AA420110000



Shavers to drill machine for STABIOXY pipes

Essentially accurate, calibratable tool for attachment to the drill. It is designed to remove the top layer of plastic and aluminum foil before welding pipes STABIOXY. Quality carbide blades. Before the first use, it is necessary to calibrate onto pipe PPR CLASSIC.

mm	pcs	mm	mm	mm	mm	#
16	pcs	1	1	0,15	0,19	AA421016000
20	pcs	1	1	0,19	0,19	AA421020000
25	pcs	1	1	0,23	0,25	AA421025000
32	pcs	1	1	0,24	0,30	AA421032000
40	pcs	1	1	0,20	0,30	AA421040000
50	pcs	1	1	0,30	0,42	AA421050000
63	pcs	1	1	0,72	1,33	AA421063000



Cordless pipe shears d40

Cordless pipe shears for fast, effortless cutting of plastic and multi-layer pipes $\varnothing \leq 40\text{mm}$, $\varnothing \leq 1\frac{1}{8}"$. Quality NiMh battery gives up to 40 minutes of work, or 400 cuts per charge.

mm	pcs	mm	mm	mm	mm	#
d40	pcs	1	1	1,57	8,00	AA422000000



Pipe cutter REMS

A quality tool for reliable separation of pipes with larger dimensions.

mm	pcs	mm	mm	mm	mm	#
d50 - 110	pcs	1	1	1,20	3,65	AA423000000



Shears

Quality tested tools with sufficient performance and comfort for professional cutting of PPR, PP-RCT, PE-RT, HDPE and PEX pipes of all supplied dimensions.

						#
M1 d32	pcs	15	1	0,34	0,96	AA424032000
MS d40	pcs	10	1	0,42	0,96	AA424040000
STANDARD d40	pcs	6	1	0,40	0,96	AA424040001
ROTURBO d40	pcs	6	1	0,45	0,92	AA424040002
M4 d63	pcs	2	1	1,17	3,17	AA424063000



Tightening spanner with belt

A tool for safe tightening of plastic nuts. Essential tool for proper fixation and tightening fittings containing a plastic with brass thread.

						#
	pcs	20	1	0,33	0,72	AA425000000



Spiral for sewer cleaning

Practical helper of each plumber.

						#
2,5 m	pcs	1	1	0,64	1,88	AA426000003
5,0 m	pcs	1	1	1,21	2,50	AA426000005
10,0 m	pcs	1	1	4,73	6,48	AA426000010
20,0 m	pcs	1	1	9,40	10,11	AA426000020
25,0 m	pcs	1	1	11,93	11,55	AA426000025



Assembly MP 75

Light fixation apparatus operated by a lever, with infinitely adjustable clamping jaws provide a firm grip and mutual welding fittings and pipes with 40-75mm. The advantage of this device is a low weight, which can be further reduced by removing the clamping jaws, it is therefore advantageous with this device works in positional welds, e.g. under the ceiling.

						#
32 - 75	pcs	1	1	22,00	160,00	AA427032070



Assembly MP 110 UD

Robust professional equipment designed for socket welding of pipes and fittings up to dimension 110mm. The set comes with a set of necessary accessories, which is stored in a practical case. As a special accessory can be ordered reduction inserts for the STABI pipes. Set includes: clamping slide (including selected fixtures) welder POLYS P-4a 1250 W, paired adapters of DT coatings 40, 50, 63, 75, 90 and 110 mm, inserts according to the selected design, stand welder, centering pin, clamping inserts, metal case for accessories, allen keys 5, 6, 8mm.

						#
40 - 110	pcs	1	1	47,00	240,00	AA428040110



Spider 125 with universal clamping

The spider is lightweight ideal equipment for quick and accurate socket fusion of polypropylene pipe and fittings from 63 mm to 125 mm. The spider is delivered in a robust, rugged stainless steel case. The product itself has a low weight, only 7,5 kg. The Spider is ideal for performing socket fusions overhead, vertically and other tight indoor spaces from the attic to the floor.

Note: The green stand is not included. It can be ordered separately under the name Spider Demo stand.

						
39 x 51 x 24 cm	pcs	1	1	14,6	47,74	AA428050125



Spider Demo stand







Holds Spider 125 for demo purposes. Practical holder for a mounting welding tool that is solid, precise and very stable despite its low weight. The advantage is easy and fast fastening and welding on the table or on the ground.

						
37 x 30 x 5,5 cm	pcs	1	1	4,90	6,11	AA428050300



Case for welding machine flat type PROFI







If you decide to build your PROFI kit for socket welding gradually, a rugged metal case will be suitable.

						
PROFI SE21	pcs	1	1	4,8	16,9	AA417001000
PROFI SE41	pcs	1	1	4,8	16,9	AA417002000



Case for welding machine flat type MINI

If you decide to build your MINI kit for socket welding gradually, a rugged metal case will be suitable.

						
MINI SM21	pcs	1	1	2,9	9,09	AA417003000
MINI SM41	pcs	1	1	2,9	9,09	AA417004000



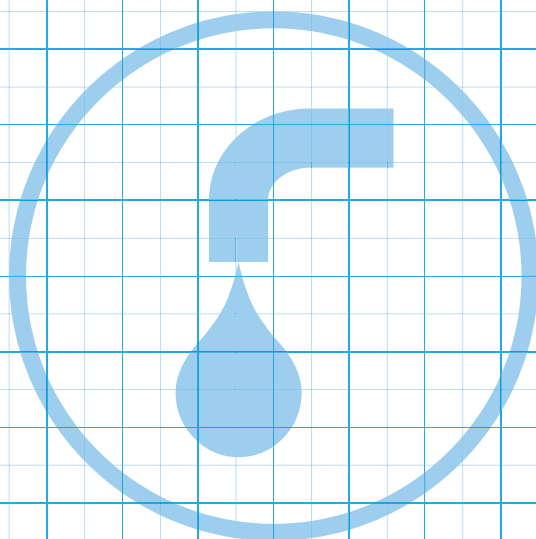



IPN20



ASSEMBLY INSTRUCTIONS

1. USE OF THE SYSTEM

System FV AQUA PPR and PP-RCT enables distribution implementations in residential houses, administrative and public buildings, in industry and agriculture.

It is intended for delivery of cold and hot water and also for central heating, provided that the prescribed rules are met. It is necessary to select suitable kind of pipes with corresponding parameters of limit operating temperature and pressure. The system FV AQUA offers pipes PPR, PPR-RCT HOT, PP-RCT UNI, FASER and STABIOXY.

The system can also be used for air distributions. A possibility of leading other liquids, gases or solids needs to be assessed individually in every particular example.

All pipes can be connected by a complete range of PPR pipe fittings by a polyfusion welding (up to the diameter of 125 mm) or by butt welding (diameters beyond 160 mm).

Water distributions

The system can be used for all inner water piping systems (cold drinking water, cold service water, hot water, circulation). An expected lifespan for a plastic piping system is 50 years providing the right material, type of a piping and correct implementation.

Type of a pipe according to the system of the hot water heating and its temperature regulation is selected by a project architect. In the case of hot water distribution, the expected maximum water temperature at the outflow tap is 57 °C as a protection against scalding, and inside the distributions themselves, there is a possibility of short-term water overheating to higher temperatures (70 °C) at the point of heating due to the hygiene, mainly in order to eliminate pathological organisms.

Heating distributions

When considering the suitability of a particular type of piping for heating, it is necessary to use the value of input calculating temperature of the heating water, which is the highest temperature that is reached in the system. A project architect of the heating system chooses it depending on the required temperature at the input of the heating units, according to technical possibilities of the source of heat and the type of expansion vessel.

Recommended values for heating			
Temperature range			
70/50°C	70/60°C	75/65°C	80/60°C
And for low temperature systems			

During the installation of a plastic piping behind a boiler we recommend, with respect to protection against the system overheating, to install 1.5 m – 2.m of metal pipings behind the boiler.

Ways of leading of the pipings for water and heating distributions are identical. The basic requirements are securing of the mechanical protection of the piping and securing the support of the pipings and dilatation compensations.

Piping can be led:

- in the grooves of walls
- in installation dividers (prewall assembly)
- in floors and ceilings
- along the walls (freely or in covers)
- in installation shafts and sewerages
- pod omítkou
- v sádkartonových příchách a podhledech

It is necessary to assess the leading of the piping outside the object according to specific conditions.

2. ASSEMBLY INSTRUCTION

2.1. Warning

During the assembly, it is only possible to use elements which were not damaged or polluted during the transport and storage.

In view of welding, the minimal temperature for the assembly of plastic distributions is +5 °C. At lower temperatures, it is difficult to ensure the conditions for the formation of quality links.

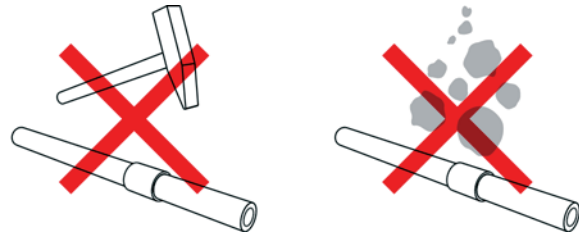

Over the whole course of assembly and transport, the elements of the plastic system must be protected against impact, shocks, falling material and other ways of mechanical damage.

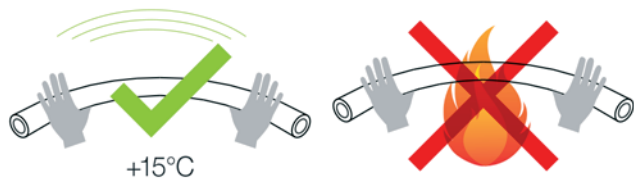

Bending of a pipe is carried out without preheating at the temperature +15°C minimum. For pipes of a diameter 16-32mm, the minimal bending diameter is 8 times the diameter of the piping (D).

It is unacceptable to bend a pipe with the aid of heating with an open flame or with hot air.

Crossing of pipes is carried out by elements designed specifically for this purpose.

Connecting of plastic parts is carried out by polyfusion welding, and also by welding with electro pipe fittings and butt welding. In the process of welding, a high-quality homogeneous link arises. For connecting, it is necessary to observe the strict procedures and use appropriate tools.

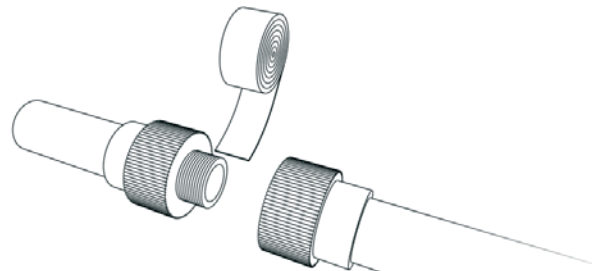

For threaded links, it is necessary to use pipe fittings with a thread. Cutting of threads on plastic elements is forbidden. Threads are sealed by Teflon tape, sealing thread or special sealants.

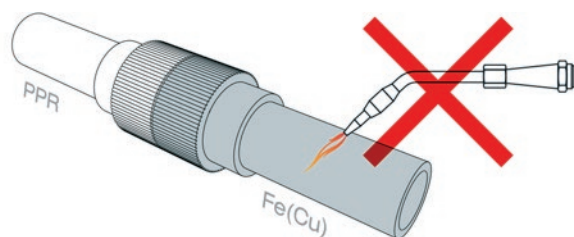

If a combined pipe fitting is followed by a metal pipe, it is not possible to connect the metal pipe in the vicinity of a pipe fitting by soldering or welding, because of possible heat transfer into the pipe fitting.

For closure of wall bends or alternatively of universal wall set before the assembly of outlet fixtures, we recommend to use plastic plugs (plastic plugs are intended only for a temporary use – e. g. pressure test). For long-term closure, plugs with a metal thread must be used.

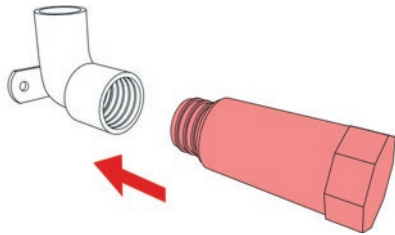

2.2 Longitudinal expansivity and contractivity

A temperature difference during the assembly and during the operation, when a medium with a different temperature than the assembly temperature is transported through the piping, causes longitudinal differences – lengthening or shortening (l).

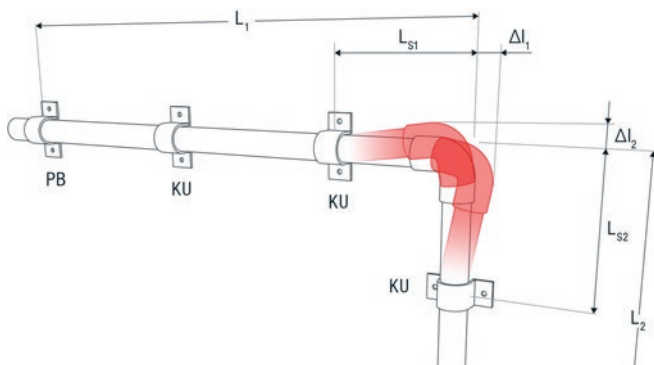

$$\Delta l = \alpha \cdot L \cdot t \text{ [mm]}$$

- Δl Longitudinal change [mm]
- α Coefficient of thermal longitudinal expansion [mm/m °C], for the all-plastic piping PPR design $\alpha = 0,15$ | for STABIOXY and FASER $\alpha = 0,05$
- L Calculating length (distance of two neighbouring fixed points in line) [m]
- t A temperature difference at assembly and at operation [°C]

$$L_s = k \cdot \sqrt[3]{(D \cdot \Delta l)} \text{ [mm]}$$

- L_s Free compensatory length
- k Material constant, for PPR $k = 20$
- D Outer diameter of piping [mm]
- Δl Longitudinal change [mm] calculated from the previous formula

U - compensator

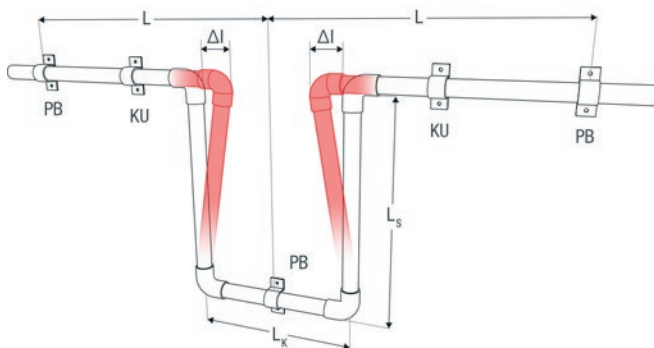

- PB Fixed point
- KU Sliding point
- L Calculating length of the piping
- L_s Compensatory length
- Δl Longitudinal change
- L_k Width of the compensator

$$L_k = 2 \cdot \Delta l + 150 \text{ [mm]} \text{ and also } L_k \geq 10 \cdot D$$

- L_k Width of the compensator
- Δl Longitudinal change [mm]
- D Outer diameter of piping

A suitable way of compensation: piping is deflected in the direction perpendicular to the original route and at this perpendicular, a free compensatory length (marked L) is left, which ensures that no significant additional pressure and tractional tensions arise in the wall of the piping. Compensatory length L_k depends on the calculated lengthening (shortening) of the route, material and the diameter of the piping. In the case of polypropylene, for compensation of longitudinal changes flexibility of the material is used. Apart from the compensation at the bending, bending "U" compensators and loop compensators are used.

The value of the longitudinal change and the value of the compensatory length can also be read from the graphs.

Table for installation of a compensation pipe

Piping diameter [mm]	Fixed points distance L [m]	
	FASER, STABIOXY	PPR and PP-RCT
16	24	8
20	27	9
25	30	10
32	36	12
40	42	14

Compensation pipe

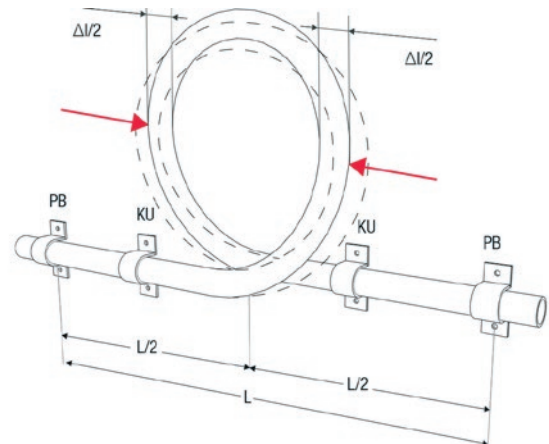

- PB Fixed point
- KU Sliding point
- L Calculating length of the piping

An example of a compensation by changing the route adapted to the building structure

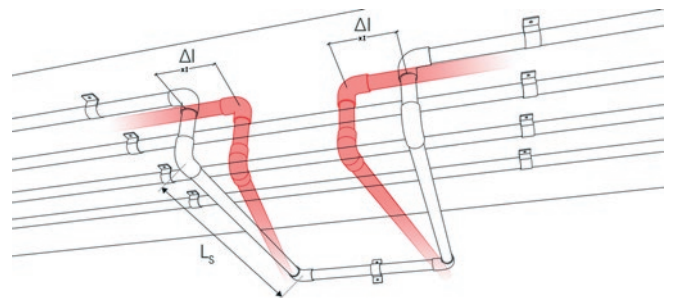

„U“ compensator

Calculated free length L means the length without any fixed supports or suspensions, which could impede the dilatation. Free length L should not exceed the maximum distance of supports according to the piping diameter and the temperature of the medium.

Longitudinal lengthening: an all-plastic piping PPR and PP-RCT

Example: L = 8m, $\Delta t = 40\text{ }^{\circ}\text{C}$

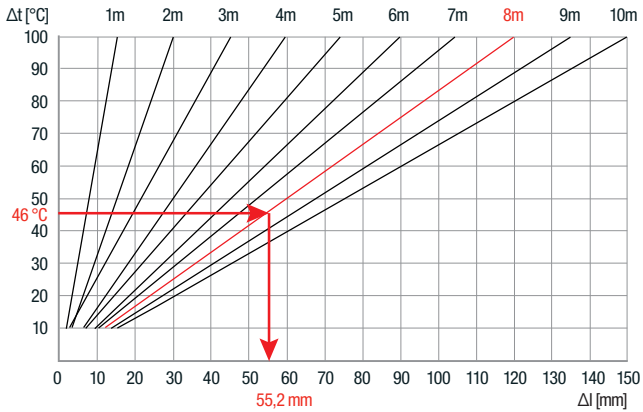

Length of piping [m]	Temperature difference Δt							
	10 °C	20 °C	30 °C	40 °C	50 °C	60 °C	70 °C	80 °C
	Length difference Δl [mm]							
1	1,5	3	5	6	8	9	11	12
2	3	6	9	12	15	18	21	24
3	5	9	14	18	23	27	32	36
4	5	9	14	18	23	27	32	36
5	8	15	23	30	38	45	53	60
6	9	18	27	36	45	54	63	72
7	11	21	32	42	53	63	74	84
8	12	24	36	48	60	72	84	96
9	14	27	41	54	68	81	95	108
10	15	30	45	60	75	90	105	120
15	23	45	68	90	113	135	158	150

Longitudinal lengthening: pipings STABIOXY and FASER

Example: L = 10m, $\Delta t = 40\text{ }^{\circ}\text{C}$

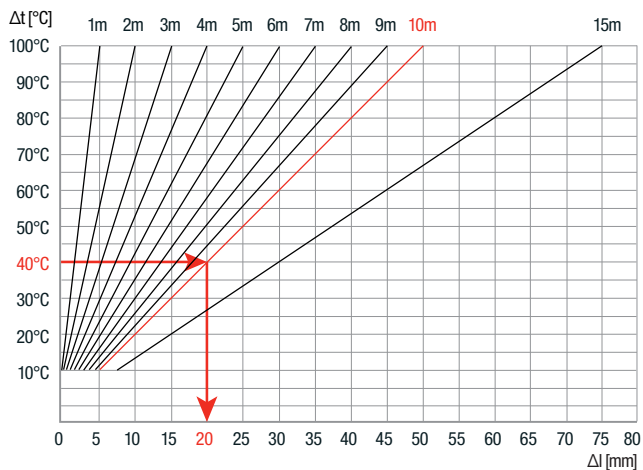

Length of piping [m]	Temperature difference Δt							
	10 °C	20 °C	30 °C	40 °C	50 °C	60 °C	70 °C	80 °C
	Longitudinal difference Δl [mm]							
1	1	1	2	2	3	3	4	4
2	1	2	3	4	5	6	7	8
3	2	3	5	6	8	9	11	12

4	2	4	6	8	10	12	14	16
5	3	5	8	10	13	15	18	20
6	3	6	9	12	15	18	21	24
7	4	7	11	14	18	21	25	28
8	4	8	12	16	20	24	28	32
9	5	9	14	18	23	27	32	36
10	5	10	15	20	25	30	35	40
15	8	15	23	30	38	45	53	60

2.3. Distances of the piping supports

Maximum distance of the supports of all-plastic pipings FV PP-RCT UNI horizontal piping.

Piping diameter [mm]	Distance of supports [cm] at the water temperature		
	20 °C	30 °C	40 °C
16	75	70	70
20	80	75	70
25	85	85	85
32	100	95	95
40	110	110	105
50	125	120	115
63	140	135	130
75	155	150	145
90	165	165	155
110	185	180	175
125	200	195	185

Maximum distance of the piping supports FV PPR CLASSIC S3,2 SDR7,4 (PN16) and FV PP-RCT HOT S3,2 SDR7,4 horizontal piping

Piping diameter [mm]	Distance of supports [cm] at the water temperature					
	20 °C	30 °C	40 °C	50 °C	60 °C	80 °C
16	80	75	75	70	70	60
20	90	80	80	80	70	65
25	95	95	95	90	80	75
32	110	105	105	100	95	80
40	120	120	115	105	100	95
50	135	130	125	120	115	100
63	155	150	145	135	130	115
75	170	165	160	150	145	125
90	180	180	170	165	160	135
110	200	195	190	180	175	155
125	220	215	200	195	190	165

Maximum distance of the piping supports FV PPR CLASSIC S2,5 SDR6 (PN 20) horizontal piping

Piping diameter [mm]	Distance of supports [cm] at the water temperature					
	20 °C	30 °C	40 °C	50 °C	60 °C	80 °C
16	90	85	85	80	80	65
20	95	90	85	85	80	70
25	100	100	100	95	90	85
32	120	115	115	110	100	90
40	130	130	125	120	115	100
50	150	150	140	130	125	110
63	170	160	155	150	145	125
75	185	180	175	160	155	140
90	200	200	185	180	175	150
110	210	215	210	195	190	165
125	235	230	225	210	200	170

Maximum distance of the piping supports FV PP-RCT FASER COOL horizontal piping.

Piping diameter [mm]	Distance of supports [cm] at the water temperature						
	20°C	30°C	40°C	50°C	60°C	70°C	80°C
40	120	115	110	105	100	95	90
50	140	135	130	125	120	115	110
63	150	145	140	135	130	125	120
75	165	160	155	150	145	140	130
90	175	170	165	160	155	150	135
110	185	180	175	165	160	155	145
125	205	195	190	180	170	160	150
160	205	195	185	180	170	160	150
200	230	220	210	205	195	185	175
250	260	250	240	230	220	210	195

Maximum distance of the piping support FV PP-RCT HOT and FV PP-RCT STABIOXY horizontal piping.

Piping diameter [mm]	Distance of supports [cm] at the water temperature						
	20°C	30°C	40°C	50°C	60°C	70°C	80°C
20	100	90	85	85	80	70	65
25	105	100	95	90	85	80	75
32	120	115	110	105	100	95	90
40	130	125	120	115	110	105	100
50	150	145	140	135	130	125	120
63	160	155	150	145	140	135	130
75	180	175	170	165	160	155	145
90	190	185	180	175	170	165	150
110	200	195	190	180	175	170	160
125	220	210	205	195	185	175	165
160	220	210	205	195	185	175	165
200	245	235	225	220	210	200	190
250	275	265	255	245	235	225	210

For vertical piping the maximum distance of supports is multiplied by the coefficient 1.3.

2.4 Pipe fixing

It is necessary to respect the material of distribution systems, i.e. primarily longitudinal thermal expansivity, necessity of compensations, given operational conditions (combination of pressure and temperature) and the way of connecting.

Fixing of distributions is carried out so as the fixed points and sliding points are distinguished, for the expected longitudinal change of the piping.

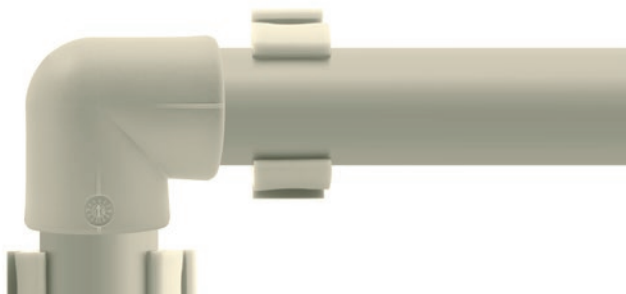

At a pipe bend

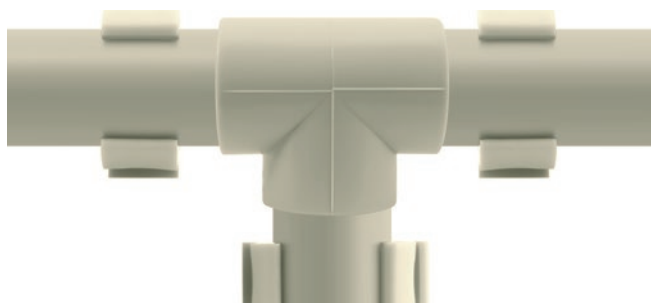

At a branching point

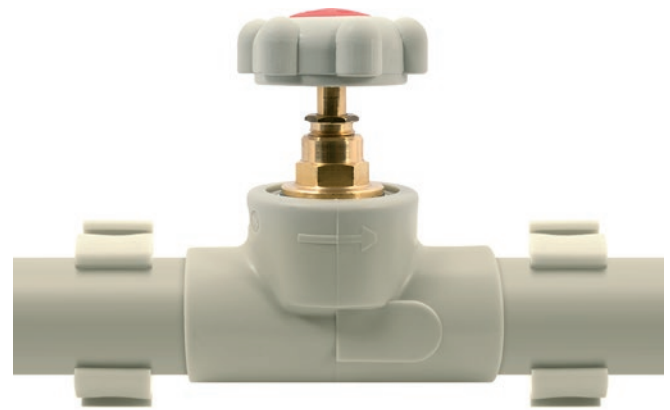

At the point of placing the fitting on the piping

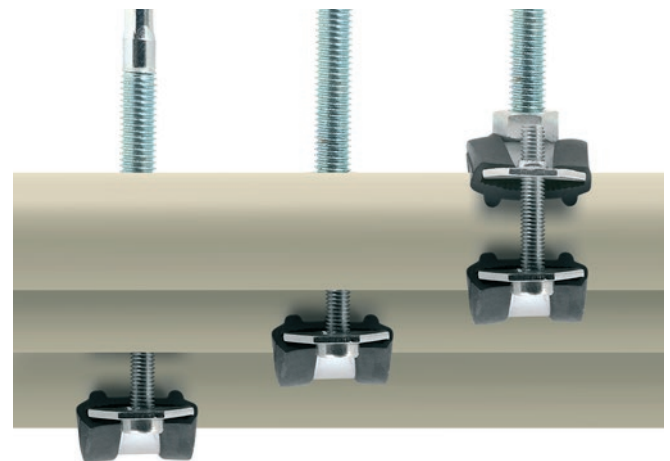

Thanks to the tightly tied sleeves (only horizontal piping)



Fixing at fitting places

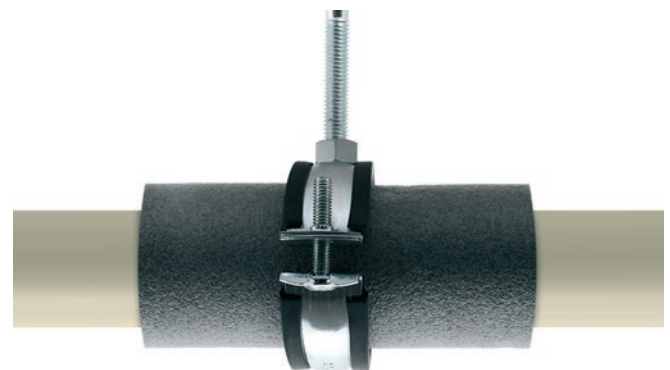

Free sleeve

Use of plastic sleeves

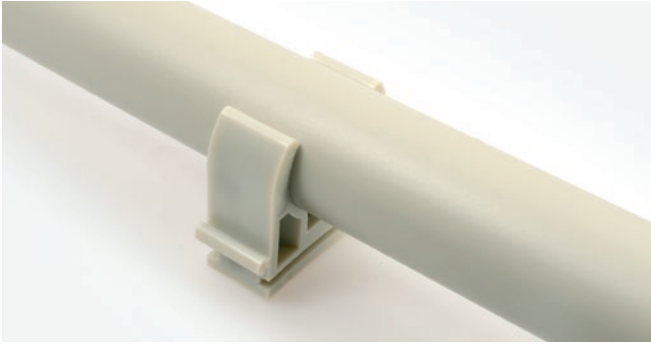

Suitable for cold water distribution systems

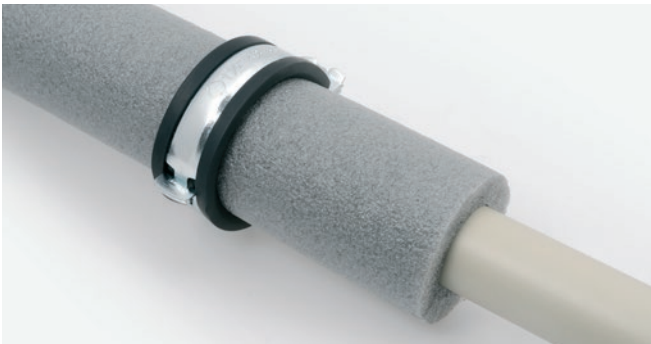

In the case of hot water, sleeve is installed with insulation that is larger by one dimension.

Another way of laying of plastic piping

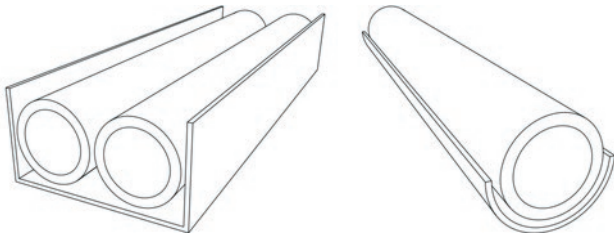

Laying of a pipe into a free gutter.

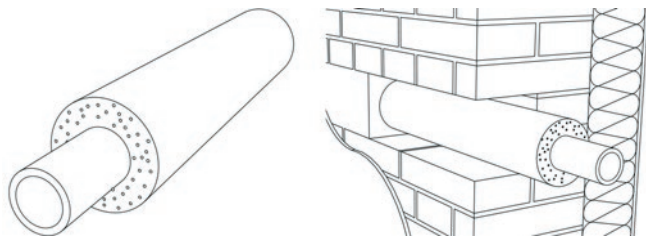

Leading of piping in insulation under plastering

Leading of piping

Piping has to be assembled with a decline of at least 0.5 % towards the lowest places, where it is possible to drain it through an independent draining or through closing valves with draining.

Piping must be divided into parts which can be closed independently. For closing, direct valves or cocks are used, for the installation under plastering under-plastering valves or cocks are used. Before the assembly of the elements, it is necessary to test their closability.

For termination of the piping at a place of mixing outlet fixture, it is recommended to use UNIVERSAL WALL MOUNTING GROUP, where the pitch of threads is slid under in such a way that after a potential deflection from the horizontal

axis the distribution could be balanced by levels (etážek). For assemblies under gypsum, a ELBOW FOR GYPSUM WALL MOUNTING should be used.

When leading a water pipe through installation partitions, it is necessary to fix the position of the pipe by suitable fixing, for example by a system of metal sleeves with supporting elements. Piping has to be led with a potential dilatation and insulated.

When leading a water pipe in floor or ceiling constructions, bendable plastic cable ducts (from polyethylene) are used, which ensure mechanical protection of the pipe and at the same time the air gap between the pipe and the cable duct creates thermal insulation. Free plastic water piping has to be furnished with quality insulation (if for example a cold water pipe is led freely at a wall in a heated room, there is a great danger of condensation of humidity at the walls of the pipe). Piping can be led freely at a wall only in premises without the danger of mechanical damage because of operation.

2.5 Leading of an ascending pipe

In the case of an ascending pipe, close attention has to be paid to the layout of fixed points, sliding points and to creating a suitable way of compensation. For ascending pipes, compensation is ensured either by a sliding point at the foot of a standpipe or by using a compensation pipe.

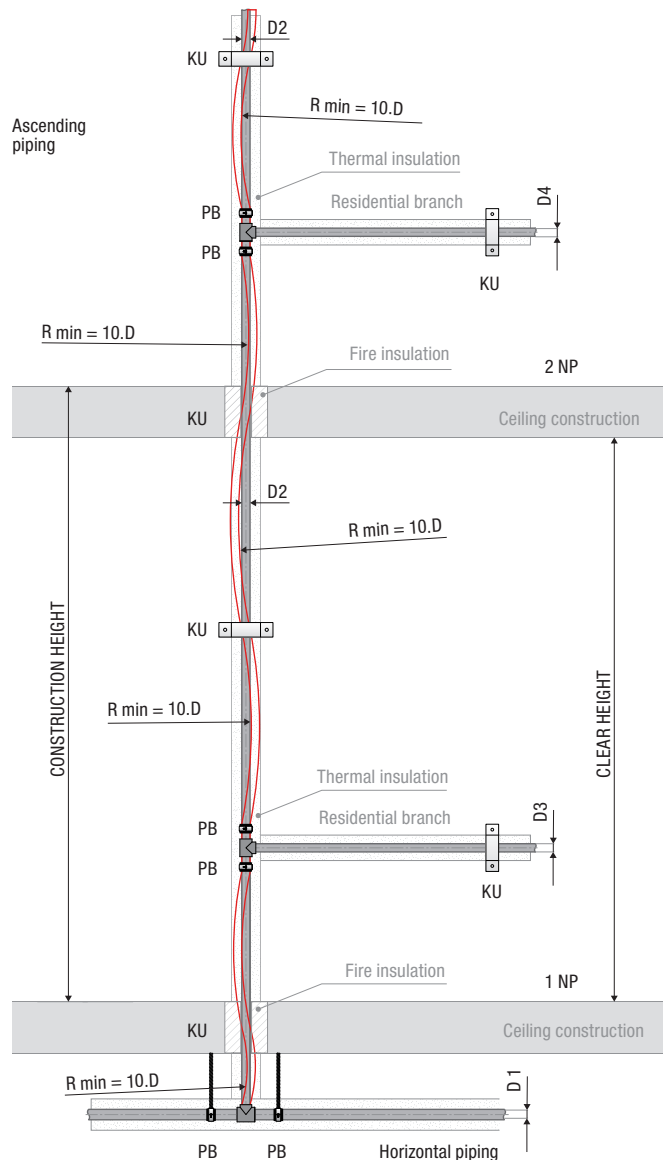

EXPLANATORY NOTES:

	Piping before heating	PB	Fixed point
	Piping after heating	KU	Sliding point
		D	Outer diameter of the piping
		R min	Minimum bend radius

Assembly regulation

If a standpipe needs to be divided into several dilatation sections, this placing of fixed points is carried out. Fixed point at an ascending pipe is installed below and above a T-piece at the branch or at a coupling sleeve at a place of pipe connection, which simultaneously prevents the standpipe from falling. Dilatation between the fixed points then needs to be enabled.

At a place of branching of a connecting pipe, a standpipe dilatation needs to be taken into account:

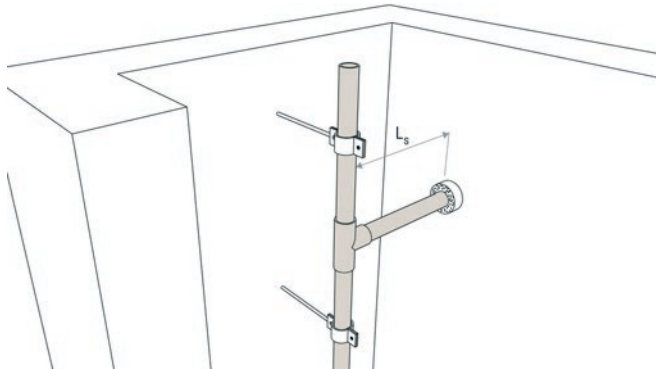

Sufficient distance of a standpipe from a wall penetration

Pipes STABI and FASER have **3x smaller expansivity and 3x higher toughness than all-plastic pipes**. Therefore, the pipes can be assembled according to the same principles that were described above in the case of all-plastic pipes, that is to say in a classical procedure of a compensation solution, where a possible larger distance of supports and dilatation and compensational length will be significantly lower. When the piping is led in a groove, so called solid assembly can also be utilized – fixed points are attached to the pipe in such a way that the thermal expansivity is transferred to the pipe material and it does not manifest. This assembly assumes sleeves which will be able to truly hold the pipe and which will be anchored firmly enough.

2.6 Connecting into a system

A piping system can be connected by welding or by mechanical links.

Connecting a pipe with a pipe fitting is carried out in the same way for all types of pipes, pipe fittings are identical. Before welding, in the case of the STABI and STABIOXY pipes, it is necessary to remove the outer PPR and the middle aluminium layer using pipe shavers to the length of the insertion.



Pipes and pipe fittings are being connected by polyfusion welding, larger diameters by means of electro pipe fitting or by butt welding. All the methods have to be carried out exactly in accordance with approved working procedures.

Dividing of pipes

Pipes can be divided (cut) only by sharply ground tools. It is recommended to use special shears or a cutter for plastic pipes.



For plastic – metal transitions in hot water and heating piping systems, plumber's unions with impressed brass nickel-plated male and female threads are strictly used.

For tightening of threaded links with impressed threads, tightening spanners with tape are used, if the plumber's union is not furnished with a polyhedron directly at its metal part.

WARNING:

Using of plumber's unions with plastic threads is unacceptable for sanitary technology, because of thermal-technical and physical-mechanical reasons. Plumber's unions with plastic threads can be used for example in the case of establishing temporary distribution systems.

Link sealing

Sealing of threaded links is carried out exclusively by Teflon tape, Teflon thread or by a special sealant .



FV
PLAST®

FV MULTIPIPES

FV MULTIPERT-AL pipe in coil

System: **FV AQUA**
 Material: PE-RT/AL/PE-RT
 Standard: ČSN EN ISO 21003, DIN 4726

Details: 5-layer polyethylene pipe PE-RT II with one layer made from aluminium, increased heat resistance (according to EN ISO 22391), with oxygen barrier from aluminium according to DIN 4726, T_{max} 95°C.

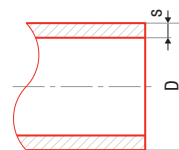

Code	Material	Length [m]	Weight [kg]	Volume [dm³]	#	D [mm]	s [mm]	l [m]
16 x 2,0	m	200	0,097	0,200	AA130016200	16	2,0	200
18 x 2,0	m	200	0,118	0,250	AA130018200	18	2,0	200
20 x 2,0	m	100	0,142	0,310	AA130020100	20	2,0	100
20 x 2,0	m	200	0,142	0,310	AA130020200	20	2,0	200
25 x 2,5	m	50	0,271	0,490	AA130025050	25	2,5	50
26 x 3,0	m	50	0,296	0,534	AA130026050	26	3,0	50
32 x 3,0	m	50	0,373	0,800	AA130032050	32	3,0	50

FV MULTIPERT-AL pipe in stick

System: **FV AQUA**
 Material: PE-RT/AL/PE-RT
 Standard: ČSN EN ISO 21003, DIN 4726

Details: 5-layer polyethylene pipe PE-RT II with one layer made from aluminium, increased heat resistance (according to EN ISO 22391), with oxygen barrier from aluminium according to DIN 4726, T_{max} 95°C.

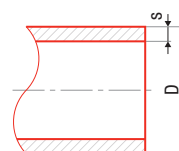

Code	Material	Length [m]	Weight [kg]	Volume [dm³]	#	D [mm]	s [mm]	l [m]
16 x 2,0	m	160	0,097	0,200	AA130016004	16	2,00	4
18 x 2,0	m	120	0,118	0,250	AA130018004	18	2,00	4
20 x 2,0	m	100	0,142	0,310	AA130020004	20	2,00	4
25 x 2,5	m	60	0,271	0,490	AA130025004	25	2,50	4
26 x 3,0	m	60	0,296	0,534	AA130026004	26	3,00	4
32 x 3,0	m	40	0,373	0,800	AA130032004	32	3,00	4
40 x 3,5	m	24	0,538	1,260	AA130040004	40	3,50	4
50 x 4,0	m	16	0,811	1,960	AA130050004	50	4,00	4
63 x 4,5	m	12	1,220	3,12	AA130063004	63	4,50	4

FV MULTIPEX-AL pipe in coil

System: **FV AQUA**
 Material: PE-Xb/AL/PE-Xb
 Standard: ČSN EN ISO 21003, DIN 4726

Details: 5-layer, particularly resistant pipe from cross-linked polyethylene PE-Xb with one layer made from aluminium, increased heat resistance (according to ČSN EN ISO 15875), with oxygen barrier from aluminium according to DIN 4726, T_{max} 110°C.

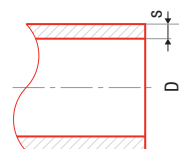

Code	Material	Length [m]	Weight [kg]	Volume [dm³]	#	D [mm]	s [mm]	l [m]
16 x 2,0	m	200	0,112	0,20	AA131016200	16	2,00	200
18 x 2,0	m	200	0,136	0,25	AA131018200	18	2,00	200
20 x 2,0	m	100	0,154	0,31	AA131020200	20	2,00	200
25 x 2,5	m	50	0,294	0,49	AA131025050	25	2,50	50
26 x 3,0	m	50	0,310	0,53	AA131026050	26	3,00	50
32 x 3,0	m	50	0,404	0,80	AA131032050	32	3,00	50

FV MULTIPEX-AL pipe in stick

System: **FV AQUA**

Material: PE-Xb/AL/PE-Xb

Standard: ČSN EN ISO 21003, DIN 4726

Details: 5-layer, particularly resistant pipe from cross-linked polyethylene PE-Xb with one layer made from aluminium, increased heat resistance (according to ČSN EN ISO 15875), with oxygen barrier from aluminium according to DIN 4726, T_{max} 110°C.

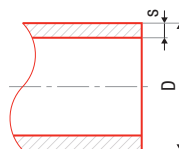

Size	Material	Length [m]	Weight [kg]	Volume [dm ³]	Code	D [mm]	s [mm]	l [m]
16 × 2,0	m	160	0,112	0,20	AA131016004	16	2,00	4
18 × 2,0	m	120	0,136	0,25	AA131018004	18	2,00	4
20 × 2,0	m	100	0,154	0,31	AA131020004	20	2,00	4
25 × 2,5	m	60	0,294	0,49	AA131025004	25	2,50	4
26 × 3,0	m	60	0,310	0,23	AA131026004	26	3,00	4
32 × 3,0	m	40	0,404	0,80	AA131032004	32	3,00	4
40 × 3,5	m	24	0,583	1,26	AA131040004	40	3,50	4
50 × 4,0	m	16	0,879	1,96	AA131050004	50	4,00	4
63 × 4,5	m	12	1,321	3,12	AA131063004	63	4,50	4

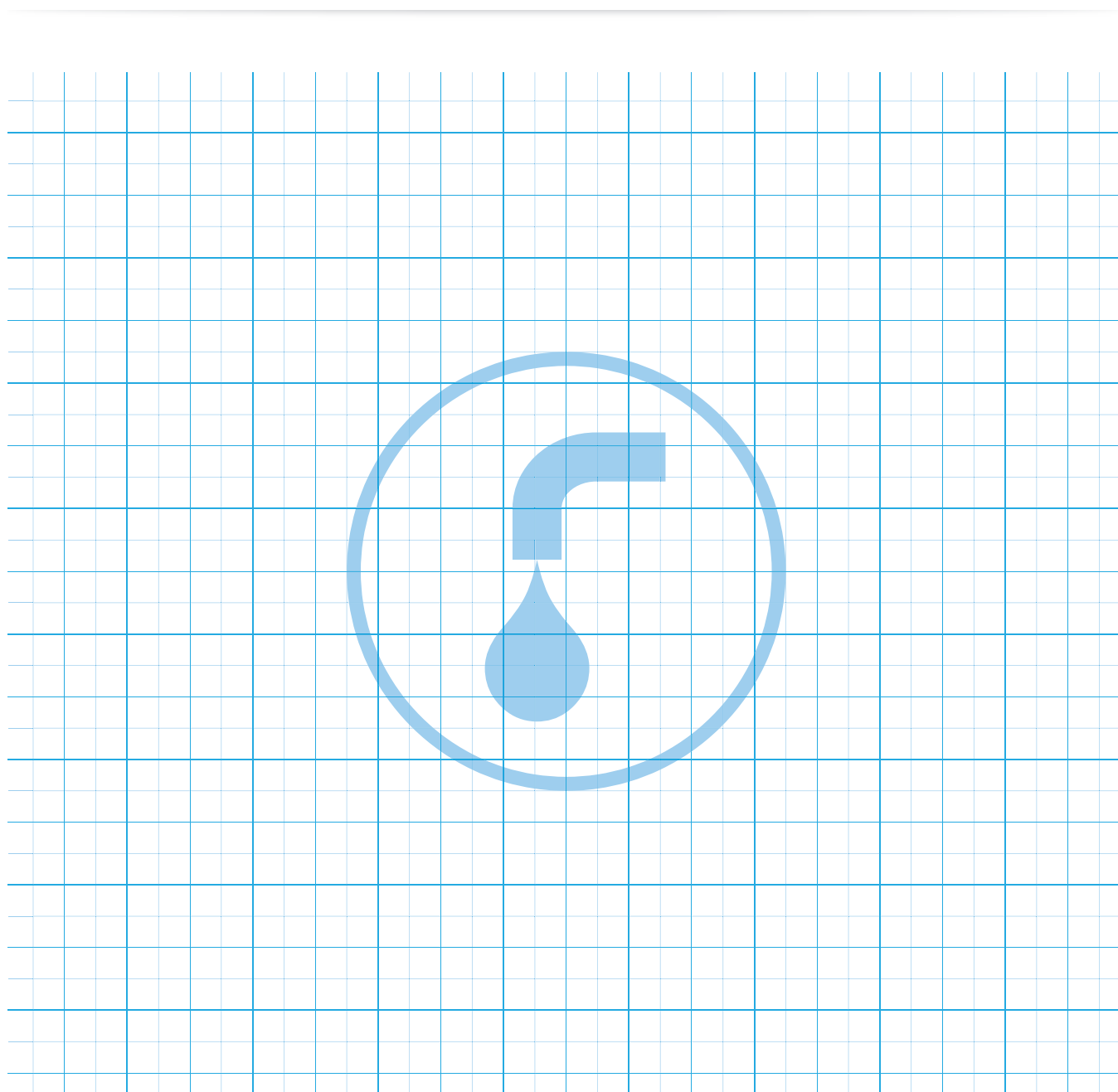

FV M-PRESS BRASS PRESS FITTINGS

FV M-PRESS reducer with cap nut

System: **FV AQUA**
 Material: MET
 Standard: EN ISO 21003
 Details: Transition fitting from FV MULTI part to metal part of pipeline.

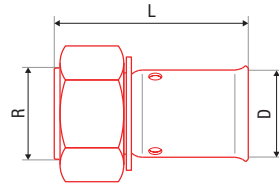

						#	D [mm]	L [mm]	R [mm]
16 x 2,0 - 3/8"	pcs		10			AA300016038	16	54	3/8"
16 x 2,0 - 1/2"	pcs		10			AA300016012	16	56	1/2"
16 x 2,0 - 3/4"	pcs		10			AA300016034	16	56	3/4"
20 x 2,0 - 1/2"	pcs		10			AA300020012	20	57	1/2"
20 x 2,0 - 3/4"	pcs		10			AA300020034	20	56	3/4"
26 x 3,0 - 3/4"	pcs		5			AA300026034	26	60	3/4"
26 x 3,0 - 1"	pcs		5			AA300026010	26	58	1"
32 x 3,0 - 1"	pcs		2			AA300032010	32	63	1"
32 x 3,0 - 1 1/4"	pcs		2			AA300032064	32	57	1 1/4"

FV M-PRESS reducing sleeve with metal female thread

System: **FV AQUA**
 Material: MET
 Standard: EN ISO 21003
 Details: Transition fitting from FV MULTI part to metal part of pipeline.

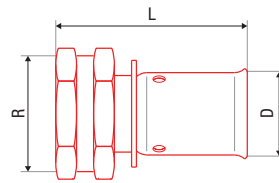

						#	D [mm]	L [mm]	R [mm]
16 x 2,0 - 1/2"	pcs		10			AA301016012	16	54	1/2"
16 x 2,0 - 3/4"	pcs		10			AA301016034	16	56	3/4"
18 x 2,0 - 1/2"	pcs		10			AA301018012	18	54	1/2"
18 x 2,0 - 3/4"	pcs		10			AA301018034	18	56	3/4"
20 x 2,0 - 1/2"	pcs		10			AA301020012	20	54	1/2"
20 x 2,0 - 3/4"	pcs		10			AA301020034	20	56	3/4"
20 x 2,0 - 1"	pcs		5			AA301020010	20	63	1"
26 x 3,0 - 3/4"	pcs		5			AA301026034	26	53	3/4"
26 x 3,0 - 1"	pcs		5			AA301026010	26	63	1"
32 x 3,0 - 1"	pcs		5			AA301032010	32	55	1"
32 x 3,0 - 1 1/4"	pcs		5			AA301032054	32	64	1 1/4"
■ 40 x 3,5 - 1 1/4"	pcs		2			AA301040054	40	62	1 1/4"
■ 50 x 4,0 - 1 1/2"	pcs		2			AA301050064	50	71	1 1/2"
■ 63 x 4,5 - 2"	pcs		2			AA301063020	63	78	2"

FV M-PRESS reducing sleeve with metal male thread

System: **FV AQUA**

Material: MET

Standard: EN ISO 21003

Details: Transition fitting from FV MULTI part to metal part of pipeline.

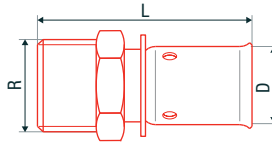

Code	Unit	Grid	Grid	Lock	Dim	#	D [mm]	L [mm]	R [mm]
16 x 2,0 - 3/8"	pcs		10			AA302016038	16	52	3/8"
16 x 2,0 - 1/2"	pcs		10			AA302016012	16	57	1/2"
16 x 2,0 - 3/4"	pcs		10			AA302016034	16	55	3/4"
18 x 2,0 - 1/2"	pcs		10			AA302018012	18	57	1/2"
18 x 2,0 - 3/4"	pcs		10			AA302018034	18	55	3/4"
20 x 2,0 - 1/2"	pcs		10			AA302020012	20	57	1/2"
20 x 2,0 - 3/4"	pcs		10			AA302020034	20	57	3/4"
26 x 3,0 - 1/2"	pcs		10			AA302026012	26	59	1/2"
26 x 3,0 - 3/4"	pcs		5			AA302026034	26	59	3/4"
26 x 3,0 - 1"	pcs		5			AA302026010	26	62	1"
32 x 3,0 - 1"	pcs		5			AA302032010	32	64	1"
■ 40 x 3,5 - 1 1/4"	pcs		2			AA302040054	40	73	1 1/4"
■ 50 x 4,0 - 1 1/2"	pcs		2			AA302050064	50	79	1 1/2"
■ 63 x 4,5 - 2"	pcs		2			AA302063020	63	89	2"

FV M-PRESS join

System: **FV AQUA**

Material: MET

Standard: EN ISO 21003

Details: A simple, reliable fitting for pipe connection.

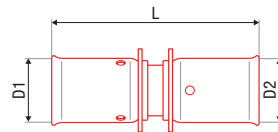

Code	Unit	Grid	Grid	Lock	Dim	#	D1 [mm]	L [mm]	D2 [mm]
16 x 2,0 x 16 x 2,0	pcs		10			AA305016000	16	66	16
18 x 2,0 x 18 x 2,0	pcs		10			AA305018000	18	66	18
20 x 2,0 x 20 x 2,0	pcs		10			AA305020000	20	66	20
26 x 3,0 x 26 x 3,0	pcs		10			AA305026000	26	66	26
32 x 3,0 x 32 x 3,0	pcs		5			AA305032000	32	68	32
■ 40 x 3,5 x 40 x 3,5	pcs		2			AA305040000	40	84	40
■ 50 x 4,0 x 50 x 4,0	pcs		2			AA305050000	50	102	50
■ 63 x 4,5 x 63 x 4,5	pcs		2			AA305063000	63	108	63

Press fittings in all metal design for pipeline diameters 16 - 32mm. The reliable joint is formed using of pressing tongs (system TH), which compresses the stainless steel ring on body of pipe and brass part of fitting. The joint is un-disassembled.



■ Press fittings with plastic ring for pipeline diameters 40 - 63mm. The reliable joint is formed using of pressing tongs (system TH), which compresses the stainless steel ring on body of pipe and brass part of fitting. The joint is un-disassembled.



FV M-PRESS reduction

System: **FV AQUA**
 Material: MET
 Standard: EN ISO 21003
 Details: A simple, reliable fitting for dimension change of pipeline.

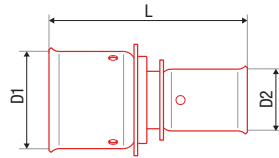

Code	Unit	Grid 1	Grid 2	Grid 3	Grid 4	#	D1 [mm]	L [mm]	D2 [mm]
18 x 2,0 - 16 x 2,0	pcs			10		AA306018016	18	66	16
20 x 2,0 - 16 x 2,0	pcs			10		AA306020016	20	66	16
20 x 2,0 - 18 x 2,0	pcs			10		AA306020018	20	66	18
26 x 3,0 - 16 x 2,0	pcs			10		AA306026016	26	66	16
26 x 3,0 - 18 x 2,0	pcs			10		AA306026018	26	66	18
26 x 3,0 - 20 x 2,0	pcs			10		AA306026020	26	66	20
32 x 3,0 - 16 x 2,0	pcs			5		AA306032016	32	68	16
32 x 3,0 - 20 x 2,0	pcs			5		AA306032020	32	68	20
32 x 3,0 - 26 x 3,0	pcs			5		AA306032026	32	68	26
40 x 3,5 - 20 x 2,0	pcs			2		AA306040020	40	80	20
40 x 3,5 - 26 x 3,0	pcs			2		AA306040026	40	80	26
40 x 3,5 - 32 x 3,0	pcs			2		AA306040032	40	80	32
50 x 4,0 - 20 x 2,0	pcs			2		AA306050020	50	91	20
50 x 4,0 - 26 x 3,0	pcs			2		AA306050026	50	91	26
50 x 4,0 - 32 x 3,0	pcs			2		AA306050032	50	90	32
50 x 4,0 - 40 x 3,5	pcs			2		AA306050040	50	92	40
63 x 4,5 - 40 x 3,5	pcs			2		AA306063040	63	96	40
63 x 4,5 - 50 x 4,0	pcs			2		AA306063050	63	103	50

FV M-PRESS elbow 90°

System: **FV AQUA**
 Material: MET
 Standard: EN ISO 21003
 Details: A simple, reliable fitting for changing the pipeline direction.

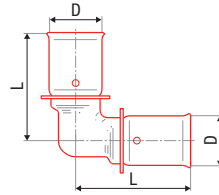

Code	Unit	Grid 1	Grid 2	Grid 3	Grid 4	#	D [mm]	L [mm]	L [mm]
16 x 2,0	pcs			10		AA309016000	16	47	47
18 x 2,0	pcs			10		AA309018000	18	50	50
20 x 2,0	pcs			5		AA309020000	20	50	50
26 x 3,0	pcs			5		AA309026000	26	52	52
32 x 3,0	pcs			5		AA309032000	32	55	55
40 x 3,5	pcs			2		AA309040000	40	66	66
50 x 4,0	pcs			2		AA309050000	50	82	82
63 x 4,5	pcs			2		AA309063000	63	87	87

FV M-PRESS elbow 45°

System: **FV AQUA**
 Material: MET
 Standard: EN ISO 21003
 Details: A simple, reliable fitting for changing the pipeline direction.

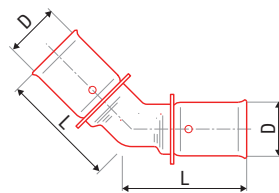

Code	Unit	Grid 1	Grid 2	Grid 3	Grid 4	#	D [mm]	L [mm]	L [mm]
16 x 2,0	pcs			10		AA304516000	16	47	47
18 x 2,0	pcs			10		AA304518000	18	50	50
20 x 2,0	pcs			5		AA304520000	20	50	50
26 x 3,0	pcs			5		AA304526000	26	52	52
32 x 3,0	pcs			5		AA304532000	32	50	50
40 x 3,5	pcs			2		AA304540000	40	58	58
50 x 4,0	pcs			2		AA304550000	50	68	68
63 x 4,5	pcs			2		AA304563000	63	69	69

FV M-PRESS elbow 90° for wall mounting

System: **FV AQUA**
 Material: MET
 Standard: EN ISO 21003
 Details: Fixing fitting with tap connector for mixers.

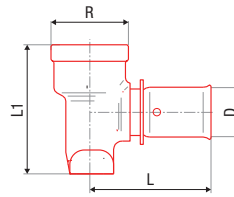

Size	Unit	Weight	Quantity	Material	Color	#	D [mm]	L [mm]	L1 [mm]
16 × 2,0 - 1/2"	pcs		5			AA310016012	26	53	53
20 × 2,0 - 1/2"	pcs		5			AA310020012	26	53	53
20 × 2,0 - 1/2"	pcs		5			AA310020034	32	53	53
20 × 2,0 - 3/4"	pcs		5			AA310025034	32	53	53

FV M-PRESS running elbow 90° for wall mounting

System: **FV AQUA**
 Material: MET
 Standard: EN ISO 21003
 Details: Fixing fitting with tap connector for mixers.

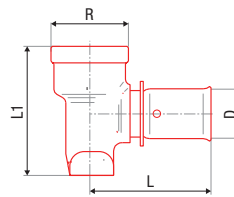

Size	Unit	Weight	Quantity	Material	Color	#	D [mm]	L [mm]	L1 [mm]
16 × 2,0 - 1/2"	pcs		5			AA310116012	16	53	53
18 × 2,0 - 1/2"	pcs		5			AA310118012	18	53	53
20 × 2,0 - 1/2"	pcs		5			AA310120012	20	53	53

FV M-PRESS running elbow 180° for wall mounting

System: **FV AQUA**
 Material: MET
 Standard: EN ISO 21003
 Details: Fixing fitting with tap connector for mixers.

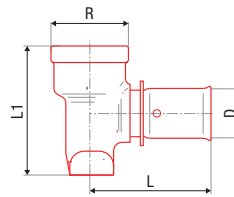

Size	Unit	Weight	Quantity	Material	Color	#	D [mm]	L [mm]	L1 [mm]
16 × 2,0 - 1/2"	pcs		5			AA310216012	16	80	40
18 × 2,0 - 1/2"	pcs		5			AA310218012	18	80	40
20 × 2,0 - 1/2"	pcs		5			AA310220012	20	80	40

FV M-PRESS elbow 90° with metal female thread

System: **FV AQUA**
 Material: MET
 Standard: EN ISO 21003
 Details: Transition fitting from FV MULTI part to metal part of pipeline.

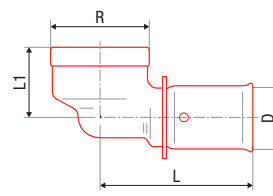

Size	Unit	Weight	Quantity	Material	Color	#	D [mm]	L [mm]	L1 [mm]
16 × 2,0 - 1/2"	pcs		10			AA312016012	16	49	34
18 × 2,0 - 1/2"	pcs		10			AA312018012	18	50	34
20 × 2,0 - 1/2"	pcs		10			AA312020012	20	50	34
20 × 2,0 - 3/4"	pcs		10			AA312020034	20	50	35
26 × 3,0 - 3/4"	pcs		5			AA312026034	26	52	40
26 × 3,0 - 1"	pcs		5			AA312026010	26	55	40
32 × 3,0 - 1"	pcs		5			AA312032010	32	55	46
40 × 3,5 - 1 1/4"	pcs		2			AA312040054	40	66	56
50 × 4,0 - 1 1/2"	pcs		2			AA312050064	50	82	64
63 × 4,5 - 2"	pcs		2			AA312063020	63	87	73

FV M-PRESS elbow 90° with metal male thread

System: **FV AQUA**
 Material: MET
 Standard: EN ISO 21003
 Details: Transition fitting from FV MULTI part to metal part of pipeline.

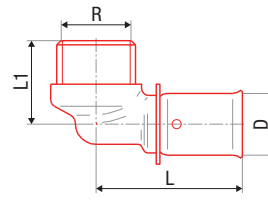

Icon	⊕	⊞	⊞	⊞	⊞	#	D [mm]	L [mm]	L1 [mm]
16 × 2,0 - 3/8"	pcs			10		AA313016038	16	49	30
16 × 2,0 - 1/2"	pcs			10		AA313016012	16	49	35
18 × 2,0 - 1/2"	pcs			10		AA313018012	18	50	35
20 × 2,0 - 1/2"	pcs			10		AA313020012	20	50	35
20 × 2,0 - 3/4"	pcs			10		AA313020034	20	50	35
26 × 3,0 - 3/4"	pcs			5		AA313026034	26	52	43
26 × 3,0 - 1"	pcs			5		AA313026010	26	52	41
32 × 3,0 - 1"	pcs			5		AA313032010	32	55	46
40 × 3,5 - 1 1/4"	pcs			2		AA313040054	40	66	56
50 × 4,0 - 1 1/2"	pcs			2		AA313050064	50	82	64
63 × 4,5 - 2"	pcs			2		AA313063020	63	87	73

FV M-PRESS elbow 90° reducing sleeve with cap nut

System: **FV AQUA**
 Material: MET
 Standard: EN ISO 21003
 Details: Transition fitting from FV MULTI part to metal part of pipeline.

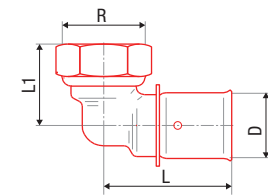

Icon	⊕	⊞	⊞	⊞	⊞	#	D [mm]	L [mm]	L1 [mm]
16 × 2,0 - 1/2"	pcs			10		AA314016012	16	49	35
16 × 2,0 - 3/4"	pcs			10		AA314016034	16	49	35
20 × 2,0 - 1/2"	pcs			10		AA314020012	20	50	35
20 × 2,0 - 3/4"	pcs			10		AA314020034	20	50	35
26 × 3,0 - 3/4"	pcs			5		AA314026034	26	52	38
26 × 3,0 - 1"	pcs			5		AA314026010	26	52	38
32 × 3,0 - 1"	pcs			5		AA314032010	32	55	41
32 × 3,0 - 1 1/4"	pcs			5		AA314032054	32	55	43

FV M-PRESS wall mounting group with tap connectors for gypsum walls

System: **FV AQUA**
 Material: MET
 Standard: EN ISO 21003
 Details: Fixing fitting with tap connector for mixers, for gypsum walls.

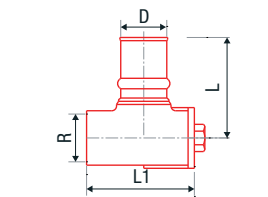

Icon	⊕	⊞	⊞	⊞	⊞	#	D [mm]	L [mm]	L1 [mm]
16 × 2,0 - 1/2"	pcs			1	115	AA315016012	16	48	51,5
20 × 2,0 - 1/2"	pcs			1	123	AA315020012	20	48	51,5

FV M-PRESS wall mounting group with tap connectors

System: **FV AQUA**
 Material: MET
 Standard: EN ISO 21003
 Details: Tap water connectors with adjustable distance.

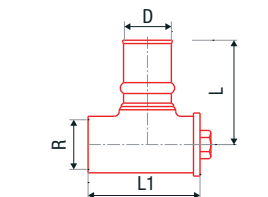

Icon	⊕	⊞	⊞	⊞	⊞	#	D [mm]	L [mm]	L1 [mm]
16 × 2,0 - 1/2"	pcs			1	115	AA316016012	16	48	51,5
20 × 2,0 - 1/2"	pcs			1	123	AA316020012	20	48	51,5

FV M-PRESS tee

System: **FV AQUA**
 Material: MET
 Standard: EN ISO 21003
 Details: A simple, reliable fitting for branching the pipeline.

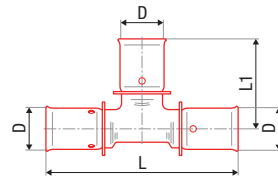

Size	Unit	Quantity	#	D [mm]	L [mm]	L1 [mm]
16 x 2,0	pcs	10	AA317016000	16	93	47
18 x 2,0	pcs	10	AA317018000	18	100	50
20 x 2,0	pcs	5	AA317020000	20	100	50
26 x 3,0	pcs	2	AA317026000	26	104	52
32 x 3,0	pcs	5	AA317032000	32	110	55
40 x 3,5	pcs	2	AA317040000	40	132	66
50 x 4,0	pcs	2	AA317050000	50	164	82
63 x 4,5	pcs	2	AA317063000	63	174	87

FV M-PRESS tee reduced

System: **FV AQUA**
 Material: MET
 Standard: EN ISO 21003
 Details: A simple, reliable fitting for branching the pipeline.

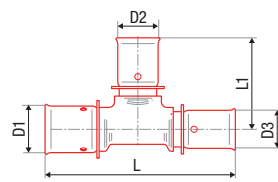

Size	Unit	Quantity	#	D1 [mm]	D2 [mm]	D3 [mm]	L [mm]	L1 [mm]
16 - 20 - 16	pcs	5	AA318162016	16	20	16	100	50
18 - 16 - 16	pcs	10	AA318181616	18	16	16	100	50
18 - 16 - 18	pcs	10	AA318181618	18	16	18	100	50
18 - 18 - 16	pcs	10	AA318181816	18	18	16	100	50
20 - 16 - 16	pcs	10	AA318201616	20	16	16	100	50
20 - 16 - 20	pcs	5	AA318201620	20	16	20	100	50
20 - 18 - 18	pcs	5	AA318201818	20	18	19	100	50
20 - 18 - 20	pcs	5	AA318201820	20	18	20	100	50
20 - 20 - 16	pcs	5	AA318202016	20	20	16	100	50
20 - 26 - 20	pcs	5	AA318202620	20	26	20	106	53
26 - 16 - 16	pcs	5	AA318261616	26	16	16	105	53
26 - 16 - 20	pcs	5	AA318261620	26	16	20	105	53
26 - 16 - 26	pcs	5	AA318261626	26	16	26	104	53
26 - 18 - 26	pcs	5	AA318261826	26	18	26	104	52
26 - 20 - 16	pcs	5	AA318262016	26	20	16	105	53
26 - 20 - 20	pcs	5	AA318262020	26	20	20	104	52
26 - 20 - 26	pcs	5	AA318262026	26	20	26	104	52
26 - 26 - 16	pcs	5	AA318262616	26	26	16	104	52
26 - 26 - 20	pcs	5	AA318262620	26	26	20	104	52
26 - 32 - 26	pcs	2	AA318263226	26	32	26	112	55
32 - 20 - 20	pcs	2	AA318322020	32	20	20	110	55
32 - 20 - 26	pcs	5	AA318322026	32	20	26	110	55
32 - 16 - 32	pcs	2	AA318321632	32	16	32	110	55
32 - 18 - 32	pcs	2	AA318321832	32	18	32	110	55
32 - 20 - 32	pcs	2	AA318322032	32	20	32	110	55
32 - 26 - 26	pcs	2	AA318322626	32	26	26	110	55
32 - 26 - 32	pcs	2	AA318322632	32	26	32	110	55
40 - 20 - 40	pcs	2	AA318402040	40	20	40	132	62
40 - 26 - 40	pcs	2	AA318402640	40	26	40	132	62
40 - 32 - 40	pcs	2	AA318403240	40	32	50	132	62
50 - 16 - 50	pcs	2	AA318501650	50	16	50	164	69
50 - 20 - 50	pcs	2	AA318502050	50	20	50	164	69
50 - 26 - 50	pcs	2	AA318502650	50	26	50	164	69
50 - 32 - 50	pcs	2	AA318503250	50	32	50	164	69
50 - 40 - 40	pcs	2	AA318504040	50	40	40	155	73
50 - 40 - 50	pcs	2	AA318504050	50	40	50	164	73
63 - 26 - 63	pcs	2	AA318632663	63	26	63	174	74
63 - 32 - 63	pcs	2	AA318633263	63	32	63	174	74
63 - 40 - 63	pcs	2	AA318634063	63	40	63	174	78
63 - 50 - 63	pcs	2	AA318635063	63	50	63	174	87

FV M-PRESS tee with metal female thread

System: **FV AQUA**
 Material: MET
 Standard: EN ISO 21003
 Details: Transition fitting from FV MULTI part to metal part of pipeline.

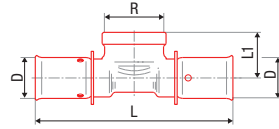

Icon	Symbol	Symbol	Symbol	Symbol	Symbol	#	D [mm]	L [mm]	L1 [mm]
	16 x 2,0 - 1/2"	pcs		5		AA319016012	16	97	34
	18 x 2,0 - 1/2"	pcs		5		AA319018012	18	100	34
	18 x 2,0 - 3/4"	pcs		5		AA319018034	18	100	35
	20 x 2,0 - 1/2"	pcs		5		AA319020012	20	100	34
	20 x 2,0 - 3/4"	pcs		5		AA319020034	20	100	35
	26 x 3,0 - 1/2"	pcs		5		AA319026012	26	104	40
	26 x 3,0 - 3/4"	pcs		5		AA319026034	26	104	40
	32 x 3,0 - 1/2"	pcs		2		AA319032012	32	110	45
	32 x 3,0 - 3/4"	pcs		2		AA319032034	32	110	46
	32 x 3,0 - 1"	pcs		2		AA319032010	32	110	46
■	40 x 3,5 - 3/4"	pcs		2		AA319040034	40	132	37
■	40 x 3,5 - 1"	pcs		2		AA319040010	40	132	57
■	40 x 3,5 - 1 1/4"	pcs		2		AA319040054	40	132	57
■	50 x 4,0 - 3/4"	pcs		2		AA319050034	50	164	37
■	50 x 4,0 - 1"	pcs		2		AA319050010	50	164	41
■	50 x 4,0 - 1 1/2"	pcs		2		AA319050064	50	164	64
■	63 x 4,5 - 3/4"	pcs		2		AA319063034	63	174	42
■	63 x 4,5 - 1"	pcs		2		AA319063010	63	174	45
■	63 x 4,5 - 2"	pcs		2		AA319063020	63	174	73

FV M-PRESS tee with metal male thread

System: **FV AQUA**
 Material: MET
 Standard: EN ISO 21003
 Details: Transition fitting from FV MULTI part to metal part of pipeline.

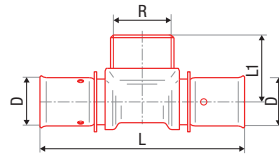

Icon	Symbol	Symbol	Symbol	Symbol	Symbol	#	D [mm]	L [mm]	L1 [mm]
	16 x 2,0 - 1/2"	pcs		5		AA320016012	16	97	35
	16 x 2,0 - 3/4"	pcs		5		AA320016034	16	97	35
	18 x 2,0 - 1/2"	pcs		5		AA320018012	18	100	35
	18 x 2,0 - 3/4"	pcs		5		AA320018034	18	100	35
	20 x 2,0 - 1/2"	pcs		5		AA320020012	20	100	35
	20 x 2,0 - 3/4"	pcs		5		AA320020034	20	100	35
	26 x 3,0 - 3/4"	pcs		5		AA320026034	26	104	43
	32 x 3,0 - 1"	pcs		2		AA320032010	32	110	46
■	40 x 3,5 - 1 1/4"	pcs		2		AA320040054	40	132	57
■	50 x 4,0 - 1 1/2"	pcs		2		AA320050064	50	164	65

FV M-PRESS shut off ball valve lux straight with chrome handle

System: **FV AQUA**
 Material: MET
 Standard: EN ISO 21003
 Details: An elegant above-plaster ball valve for closing branches of a distribution system.

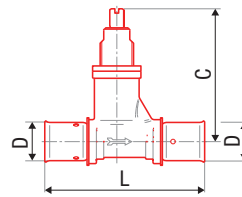

Icon	Symbol	Symbol	Symbol	Symbol	Symbol	#	L [mm]	C _{min} -C _{max} [mm]	E _{max} [mm]
	16 x 2,0	pcs		4		AA321016000	148	23 - 38	86
	18 x 2,0	pcs		4		AA321018000	148	23 - 38	86
	20 x 2,0	pcs		4		AA321020000	148	23 - 38	86
	26 x 3,0	pcs		4		AA321026000	154	26 - 41	89

FV M-PRESS shut off ball valve straight with cover

System: **FV AQUA**

Material: MET

Standard: EN ISO 21003

Details: An elegant above-plaster ball valve for closing branches of a distribution system.

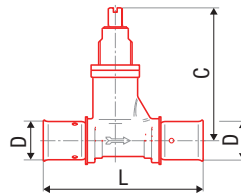

						#	L [mm]	C _{min} -C _{max} [mm]	E _{min} -E _{max} [mm]
16 × 2,0	pcs		4			AA323016000	148	36 - 51	83 - 96
18 × 2,0	pcs		4			AA323018000	148	36 - 51	83 - 96
20 × 2,0	pcs		4			AA323020000	148	36 - 51	83 - 96
26 × 3,0	pcs		4			AA323026000	154	39 - 54	86 - 99

FV M-PRESS joining elbow 90° to the radiator

System: **FV AQUA**

Material: MET

Standard: EN ISO 21003

Details: For radiator connection.

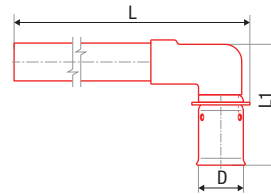

						#	D [mm]	L [mm]	
16 × 2,0 - Cu 15	pcs		2			AA324016015	15	300	
20 × 2,0 - Cu 15	pcs		2			AA324020015	15	300	

FV M-PRESS reducing sleeve to CU

System: **FV AQUA**

Material: MET

Standard: EN ISO 21003

Details: Transition fitting from FV MULTI part to cooper part of pipeline.

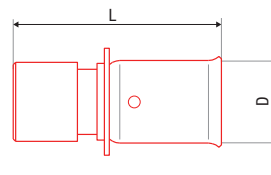

						#	D [mm]	L [mm]	
16 × 2,0 - Cu 14	pcs		10			AA326016014	16	62	
16 × 2,0 - Cu 15	pcs		10			AA326016015	16	62	
16 × 2,0 - Cu 16	pcs		10			AA326016016	16	62	
20 × 2,0 - Cu 18	pcs		10			AA326020018	20	63	
25 × 2,0 - Cu 22	pcs		10			AA326020022	25	60	

FV M-PRESS blinding

System: **FV AQUA**

Material: MET

Standard: EN ISO 21003

Details: For permanent or temporary blinding of a branch.

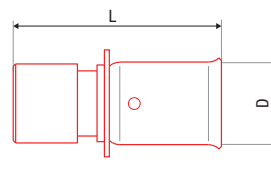

						#	D [mm]	L [mm]	
16 × 2,0	pcs		10			AA327016000	16	35	
18 × 2,0	pcs		10			AA327018000	18	35	
20 × 2,0	pcs		10			AA327020000	20	35	
26 × 3,0	pcs		10			AA327026000	26	35	
32 × 3,0	pcs		10			AA327032000	32	36	

FV P-PRESS PLASTIC PRESS FITTINGS

FV P-PRESS reducing sleeve with metal male thread

System: **FV AQUA**
 Material: PPSU/stainless steel, *brass/stainless steel
 Standard: EN ISO 15875, EN ISO 21003
 Details: Transition fitting from FV MULTI part to metal part of pipeline.

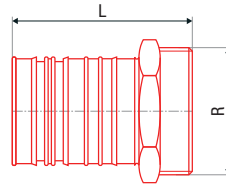

Image	Symbol	Grid	Grid	Grid	#	R	L [mm]	
	pcs			5	AA350016012	1/2"	48	
	pcs			5	AA350020012	1/2"	48	
	pcs			5	AA350020034	3/4"	50	
	pcs			5	AA350025034	3/4"	55	
	pcs			5	AA350025010	1"	42	
	pcs			5	AA350032010	1"	43	
	pcs			1	AA350040054	1 1/4"	55	

FV P-PRESS reducing sleeve with metal female thread

System: **FV AQUA**
 Material: brass/stainless steel
 Standard: EN ISO 15875, EN ISO 21003
 Details: Transition fitting from FV MULTI part to metal part of pipeline.

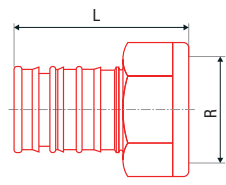

Image	Symbol	Grid	Grid	Grid	#	R	L [mm]	
	pcs			5	AA351016012	1/2"	48	
	pcs			5	AA351020012	1/2"	48	
	pcs			5	AA351020034	3/4"	50	
	pcs			5	AA351025034	3/4"	55	
	pcs			5	AA351032010	1"	43	

FV P-PRESS reducer with cap nut

System: **FV AQUA**
 Material: PPSU/stainless steel, *brass/stainless steel
 Standard: EN ISO 15875, EN ISO 21003
 Details: Transition fitting from FV MULTI part to metal part of pipeline.

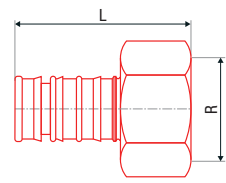
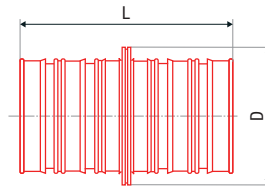

Image	Symbol	Grid	Grid	Grid	#	R	L [mm]	
	pcs			5	AA352016012	1/2"	40	
	pcs			5	AA352020012	1/2"	40	
	pcs			5	AA352020034	3/4"	42	
	pcs			5	AA352025034	3/4"	47	
	pcs			5	AA352025010	1"	39	
	pcs			5	AA352032010	1"	47	
	pcs			1	AA352040054	1 1/4"	47	

FV P-PRESS join

System: **FV AQUA**
 Material: PPSU/stainless steel, *brass/stainless steel
 Standard: EN ISO 15875, EN ISO 21003
 Details: A simple, reliable fitting for pipe connection.



Code	Unit	Material	Quantity	Weight	#	D [mm]	L [mm]	
16 - 16	pcs		5		AA353016016	20	42	
20 - 20	pcs		5		AA353020020	25	43	
25 - 25	pcs		5		AA353025025	30	53	
32 - 32	pcs		5		AA353032032	35	56	
* 40 - 40	pcs		1		AA353040040	40	77	

FV P-PRESS reduction

System: **FV AQUA**
 Material: PPSU/stainless steel, *brass/stainless steel
 Standard: EN ISO 15875, EN ISO 21003
 Details: A simple, reliable fitting for dimension change of pipeline.

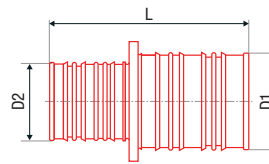

Code	Unit	Material	Quantity	Weight	#	D1 [mm]	D2 [mm]	L [mm]
20 - 16	pcs		5		AA354020016	20	16	43
25 - 16	pcs		5		AA354025016	25	16	48
25 - 20	pcs		5		AA354025020	25	20	48
32 - 25	pcs		5		AA354032025	32	25	54
* 32 - 40	pcs		1		AA354040032	40	32	66

FV P-PRESS elbow 90°

System: **FV AQUA**
 Material: PPSU/stainless steel, *brass/stainless steel
 Standard: EN ISO 15875, EN ISO 21003
 Details: A simple, reliable fitting for changing the pipeline direction.

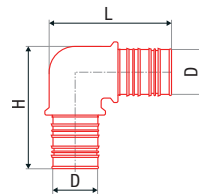

Code	Unit	Material	Quantity	Weight	#	D [mm]	L [mm]	H [mm]
16 x 2,0	pcs		5		AA355016000	16	36	41
20 x 2,0	pcs		5		AA355020000	20	45	42
25 x 2,5	pcs		5		AA355025000	25	53	53
32 x 3,0	pcs		5		AA355032000	32	61	61
* 40 x 3,5	pcs		1		AA355040000	40	85	85

FV P-PRESS blinding

System: **FV AQUA**
 Material: * PPSU/stainless steel, brass/stainless steel
 Standard: EN ISO 15875, EN ISO 21003
 Details: For permanent or temporary blinding of a branch.

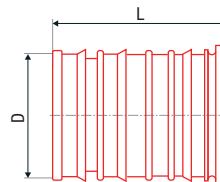

Code	Unit	Material	Quantity	Weight	#	D [mm]	L [mm]	
* 16 x 2,0	pcs		5		AA358016000	16	24	
20 x 2,0	pcs		5		AA358020000	20	23	
25 x 2,5	pcs		5		AA358025000	25	28	

FV P-PRESS tee

System: **FV AQUA**
 Material: PPSU, *brass/stainless steel
 Standard: EN ISO 15875, EN ISO 21003
 Details: A simple, reliable fitting for branching the pipeline.

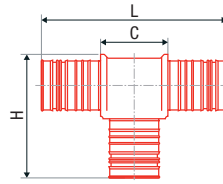

Code	Unit	Material	Standard	Weight	#	L [mm]	H [mm]	C [mm]
16 - 16 - 16	pcs			5	AA356016000	66	39	29
20 - 20 - 20	pcs			5	AA356020000	73	45	33
25 - 25 - 25	pcs			5	AA356025000	80	55	30
32 - 32 - 32	pcs			5	AA356032000	97	66	44
* 40 - 40 - 40	pcs			1	AA356040000	67	87	61

FV P-PRESS tee reduced

System: **FV AQUA**
 Material: PPSU/brass, *brass/stainless steel
 Standard: EN ISO 15875, EN ISO 21003
 Details: A simple, reliable fitting for branching the pipeline.

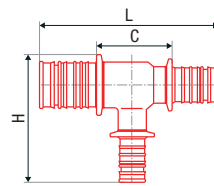

Code	Unit	Material	Standard	Weight	#	C [mm]	L [mm]	H [mm]
20 - 16 - 18	pcs			5	AA357201618	31	69	41
16 - 20 - 20	pcs			5	AA357202016	29	65	42
20 - 16 - 20	pcs			5	AA357201600	33	73	41
20 - 25 - 20	pcs			5	AA357202500	32	72	53
25 - 16 - 25	pcs			5	AA357251600	30	80	48
25 - 16 - 16	pcs			5	AA357251616	34	78	57
25 - 16 - 20	pcs			5	AA357251620	34	79	56
25 - 20 - 16	pcs			5	AA357251620	34	78	57
25 - 20 - 20	pcs			5	AA357252020	31	76	47
25 - 20 - 25	pcs			5	AA357252000	30	80	48
25 - 32 - 25	pcs			5	AA357253200	44	97	66
32 - 25 - 25	pcs			5	AA357322525	45	97	66
32 - 25 - 32	pcs			5	AA357322500	44	97	66
* 40 - 32 - 32	pcs			5	AA357403232	61	56	76

FV P-PRESS manifold 4 circuits

System: **FV AQUA**
 Material: PPSU/stainless steel
 Standard: EN ISO 15875, EN ISO 21003
 Details: A simple, reliable fitting for branching pipeline into 3 branches.

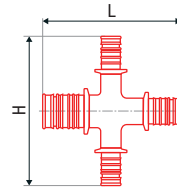

Code	Unit	Material	Standard	Weight	#	L [mm]	H [mm]
25 - 16 - 16 - 20	pcs			1	AA359251620	81	89

FV P-PRESS manifold 5 circuits

System: **FV AQUA**

Material: PPSU/stainless steel

Standard: EN ISO 15875, EN ISO 21003

Details: A simple, reliable fitting for branching pipeline into 4 branches.

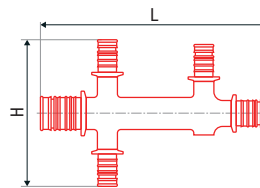

Code	Unit	Qty	Material	#	L [mm]	H [mm]
25 - 16 - 16 - 16 - 16 - 20	pcs	1	AA360251620	139	89	
32 - 16 - 16 - 16 - 16 - 20	pcs	1	AA360321620	138	95	

FV P-PRESS manifold 6 circuits

System: **FV AQUA**

Material: PPSU/stainless steel

Standard: EN ISO 15875, EN ISO 21003

Details: A simple, reliable fitting for branching pipeline into 5 branches.

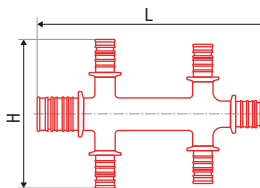

Code	Unit	Qty	Material	#	L [mm]	H [mm]
25 - 16 - 16 - 16 - 16 - 16 - 20	pcs	1	AA361251620	139	89	
32 - 16 - 16 - 16 - 16 - 16 - 20	pcs	1	AA361321620	138	95	

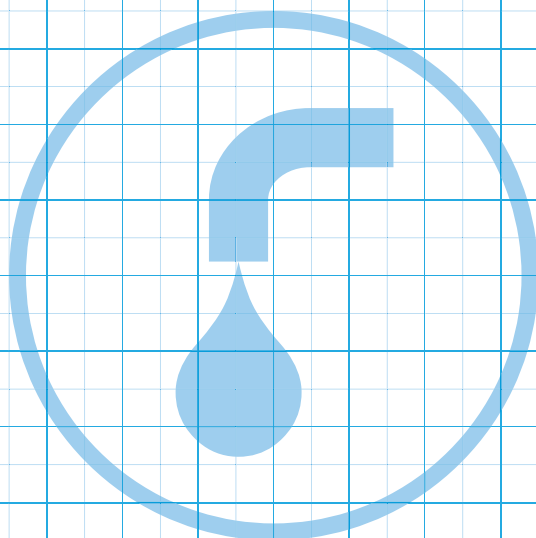

TOOLS AND ACCESSORIES FOR FV MULTI

Calibrator for FV P-PRESS metal

System: **FV AQUA**
 Material: -
 Standard: -
 Details: Robust metal calibrator for the most common diameters of multilayer pipes 16, 20, 25, 32.



Image	Symbol	Unit	QTY	QTY	Unit	#			
	pcs	1	1		dm³	AA429000000			

Calibrator for FV M-PRESS metal

System: **FV AQUA**
 Material: -
 Standard: -
 Details: Robust metal calibrator for the most common diameters of multilayer pipes 16, 20, 26, 32.



Image	Symbol	Unit	QTY	QTY	Unit	#			
	pcs	1	1		dm³	AA429000001			

Calibrator for FV M-PRESS plastic

System: **FV AQUA**
 Material: -
 Standard: -
 Details: Calibrator of multilayer pipes FV MULTI for press fittings FV M-PRESS.



Image	Symbol	Unit	QTY	QTY	Unit	#			
	pcs	5	1		dm³	AA429000002			

Calibrator for FV M-PRESS plastic with shaver

System: **FV AQUA**
 Material: -
 Standard: -
 Details: Calibrator of multilayer pipes FV MULTI for press fittings FV M-PRESS. For diameters 14 - 63 mm.



Image	Symbol	Unit	QTY	QTY	Unit	#			
	pcs	1	1		dm³	AA429000003			
	pcs	1	1		dm³	AA429000004			
	pcs	1	1		dm³	AA429000005			

Bending pipe spring outer for FV MULTIPIPES

System: **FV AQUA**
 Material: -
 Standard: -
 Details: Bending spring ensures a perfect fold multilayer pipes without the risk of pipe breakage.



Image	Symbol	Unit	QTY	QTY	Unit	#			
	pcs	1	1		dm³	AA421016000			
	pcs	1	1		dm³	AA421018000			
	pcs	1	1		dm³	AA421020000			
	pcs	1	1		dm³	AA421026000			

Bending pipe spring inner for FV MULTAPIPES

System: **FV AQUA**

Material: -

Standard: -

Details: Bending spring ensures a perfect fold multilayer pipes without the risk of pipe breakage.



						#			
16 x 2,0	pcs	1	1			AA421016001			
18 x 2,0	pcs	1	1			AA421018001			
20 x 2,0	pcs	1	1			AA421020001			
23 x 3,0	pcs	1	1			AA421026001			

REMS pressing jaws Basic E 01

System: **FV AQUA**

Material: -

Standard: -

Details: Universal pressing jaws, for clamping TC inserts for pressing plastic fittings FV P-PRESS. Universal pressing jaws are clamping into the most widely used hydraulic tools.



						#			
16x2,0 - 32x3,0	pcs	1	1			AA422000001			

REMS pressing jaws Mini Basic E 01

System: **FV AQUA**

Material: -

Standard: -

Details: Universal pressing jaws, for clamping TC inserts for pressing plastic fittings FV P-PRESS. Universal pressing jaws are clamping into the most widely used hydraulic tools.



						#			
16x2,0 - 32x3,0	pcs	5	1			AA422000002			

TC inserts into universal pressing jaws for fittings FV P-PRESS

System: **FV AQUA**

Material: -

Standard: -

Details: Special TC inserts into universal jaws E01 BASIC and E01 BASIC MINI for pressing plastic fittings FV P-PRESS. They are suitable for the most widely used hydraulic tools REMS, VIRAX, ROTTENBERGER and KLAUKE for forces from 32 to 40 KN.



						#			
16 x 2,0	pcs	1	1			AA422016000			
18 x 2,0	pcs	1	1			AA422018000			
20 x 2,0	pcs	1	1			AA422020000			
26 x 3,0	pcs	1	1			AA422026000			
32 x 3,0	pcs	1	1			AA422032000			

ASSEMBLY INSTRUCTIONS FOR CONNECTING OF PIPES WITH PIPE FITTINGS FV M-PRESS AND FV P-PRESS

CHARACTERISTICS

Pipe fittings FV M-PRESS and FV P-PRESS are intended for construction of water and heating distribution systems from multi-layer pipes FV MULTIPERT-5, FV MULTIPERT-AL, FV MULTIPLEX-5 a FV MULTIPLEX-AL

FV M-PRESS:

- Complete line of first-rate brass pressed pipe fittings for a wide range of uses. Even for the most demanding implementations as in the cases of heating water distribution systems.
- Wide range of diameters from d16 to d63 (according to the type of a pipe fitting)
- Plumber's union with outer or inner thread, eurocone, a cap nut and plumber's union to copper distribution systems, connected by pressing or soldering, ensure an easy connection to any other distribution system.
- Floor or ceiling distributors, unique double-circuit distributor with crossing, elbows and T-pieces for connecting radiators for an easy implementation of heating distributions.

FV P-PRESS

- Line of the most important plastic press pipe fittings made of the PPSU material for economical implementation of distribution systems
- Range from d16 to d32

CONNECTING BY PRESS FITTINGS

FV M-PRESS AND FV P-PRESS

Pipe fittings FV M-PRESS are fundamentally based on perfect sealing of impressed link by means of specially shaped grooves, rubber o-rings and adjustable placement of a cup.



Picture 1: Stainless steel cup ① is attached in adjustable placement ②, which is adapted to the shape of the pressing jaw in the process of pressing and its connection with fitting remains impermeable for penetration of humidity (from the plastering or condensate). Two sealing o-rings ③ ensure perfect sealing of the inner space of the fitting against the pressurized water. The inner space of the fitting is thus protected against humidity thereby successfully preventing potential corrosion of the Al layer at the cut of multi-layer pipes.

Perfect impressing of the link ④ is ensured by the Autolock system, which prevents drawing the jaws of pressing extensions away before the pressing is finished.

Fittings of the line FV M-PRESS meet the most rigorous requirements for ensuring tightness and harmlessness according to the demands of SKZ and DVGW certification authorities).

Pressing fittings FV P-PRESS work along a similar principle with simpler construction. They use different (patented) system of grooves in combination with one sealing o-ring.

Picture 1:

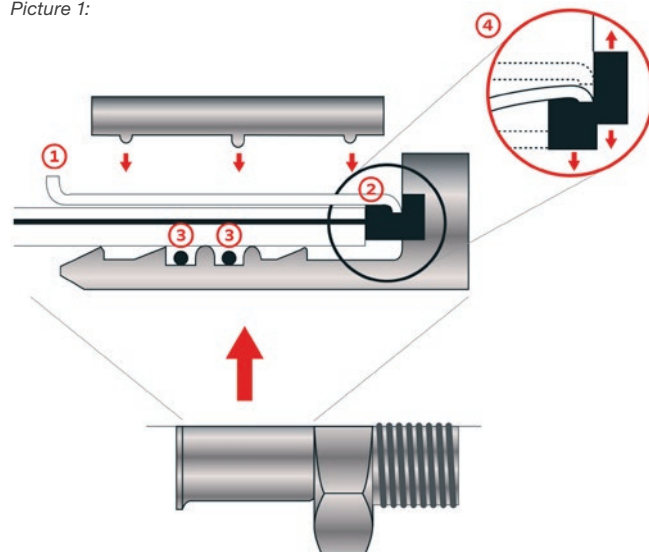

For pressing of FV M-PRESS fittings, standard pressing jaws of the following types are used:

16 × 2,0	=	U, H, TH and RF
18 × 2,0	=	U and H
20 × 2,0	=	U, H, TH and RF
25 × 2,5	=	U, H, TH and RF
32 × 3,0	=	U, H, TH and RF
40 × 3,5	=	U
50 × 4,0	=	U
63 × 4,5	=	U

For pressing of FV P-Press fittings, it is necessary to use TC insertion for universal pressing heads as jaws:

16 × 2,0	=	TC
18 × 2,0	=	TC
20 × 2,0	=	TC
25 × 2,5	=	TC
32 × 3,0	=	TC

TC insertions can be found in the FV AQUA offer – Tools and equipment. Insertions are compatible with usual hydraulic tools of the brands REMS, VIRAX, ROTTENBERGER and KLAUKE for forces from 32 to 40 kN.

PROCEDURE FOR CONNECTING IS IDENTICAL FOR BOTH FV M-PRESS AND FV P-PRESS PIPE FITTINGS:

1. Cut the pipe to a required size with quality shears or a pipe cutter, always PERPENDICULARLY to the pipe.
2. Calibrate the pipe with the pipe calibrator – this way you prevent its damage when sliding onto the fitting.
3. Separate the cup from the pipe fitting and slide the pipe to the sticking point.
4. Slide the pipe with the cup onto the fitting to the sticking point. Correctness of the fitting can be verified by the fact that the pipe must be visible in the checking window on the cup.
5. Insert the pipe fitting in the pressing jaw, so that the cup is centred in the jaws. Never press with jaws covering the edge of the cup!
6. Press the link perfectly.

Simplified procedure in which the cup is left on the piping is not recommended, mainly because of the lack of control over potential deformation or possible o-ring displacement.

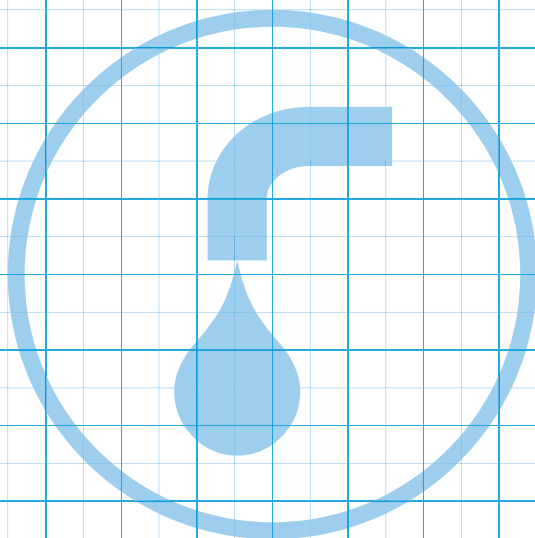
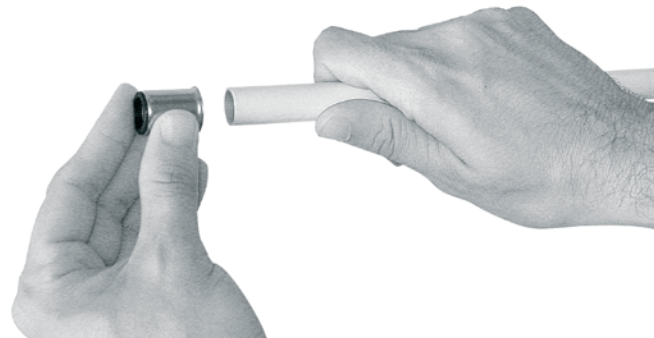
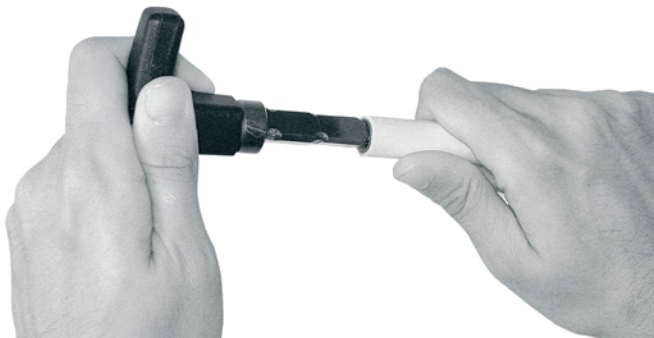

ACCESSORIES

Pipe insulation Tubex (foamed PE)

System: **FV AQUA**
 Material: PE
 Standard: -

Details: Excellent supplement for thermal and acoustic insulation of water distribution and heating. Made of polyethylene foam with soft structure of closed cells. Significantly reduce thermal losses, prevents condensation on distribution of cold water and cooling devices, muffle sound.



mm	⊕	⊞	⊞	⊞	dm ³	#			
18 × 6	m	520	2	0,01	0,92	AA970018006			
18 × 10	m	320	2	0,02	1,50	AA970018010			
22 × 6	m	400	2	0,02	1,20	AA970022006			
22 × 10	m	270	2	0,04	1,78	AA970022010			
28 × 6	m	280	2	0,02	1,71	AA970028006			
28 × 10	m	190	2	0,04	2,53	AA970028010			
35 × 6	m	210	2	0,03	2,29	AA970035006			
35 × 10	m	150	2	0,04	3,20	AA970035010			
42 × 10	m	120	2	0,04	4,00	AA970042010			
42 × 15	m	80	2	0,07	6,00	AA970042015			
52 × 10	m	80	2	0,07	6,00	AA970052010			
52 × 15	m	70	2	0,10	6,86	AA970052015			
65 × 10	m	66	2	0,08	7,27	AA970065010			
65 × 15	m	54	2	0,11	8,89	AA970065015			
76 × 10	m	50	2	0,11	9,60	AA970076010			
76 × 15	m	38	2	0,11	12,63	AA970076015			
92 × 15	m	28	2	0,14	17,14	AA970092015			
92 × 20	m	24	2	0,20	20,00	AA970092020			
114 × 15	m	20	2	0,56	24,00	AA970114015			

Adhesive insulation tape

System: **FV AQUA**
 Material: -
 Standard: -

Details: Double - adhesive tape for attaching insulation on the pipe.



mm	⊕	⊞	⊞	⊞	dm ³	#			
40 mm × 25 m	pcs	25	25	0,214	2,12	AA971000000			

Adhesive tape

System: **FV AQUA**
 Material: -
 Standard: -

Details: Special tape for pasting the cut insulation.

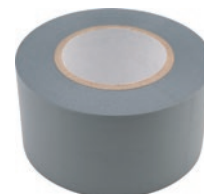

mm	⊕	⊞	⊞	⊞	dm ³	#			
40 mm × 20 m	pcs	20	20	0,142	0,176	AA972000020			

Insulation clip

System: **FV AQUA**
 Material: PPR
 Standard: -
 Details: Special clip for providing insulation of distribution without spaces.



						#			
	pcs	10000	100	0,01	0,01	AA973000000			

Insulation felt

System: **FV AQUA**
 Material: -
 Standard: -
 Details: For thermal insulation of pipes in spaces, where can not be used Tubex insulation.



						#			
	pcs	50	50	0,16	3,10	AA974000000			

O-ring Taboren

System: **FV AQUA**
 Material: PE
 Standard: -
 Details: Special seal for sealing the fittings with cap nut.



						#			
1/2"	pcs	6000	200	0,01	0,01	AA975000012			
3/4"	pcs	3000	300	0,01	0,01	AA975000034			
1"	pcs	2000	300	0,01	0,01	AA975000010			
5/4"	pcs	1400	300	0,01	0,01	AA975000054			
6/4"	pcs	1000	300	0,01	0,01	AA975000064			
2"	pcs	600	300	0,01	0,01	AA975000020			

Teflon insulation tape

System: **FV AQUA**
 Material: -
 Standard: -
 Details: Tape for sealing of fittings with metal thread.



						#			
10 m	pcs	300	10	0,01	0,06	AA975001010			

Plastic clip PP

System: **FV AQUA**

Material: PPR

Standard: -

Details: Plastic clip for sliding point of pipe on the wall.

Note: When ordering the black color of the clip, replace the AA ... for BB ..., or contact the customer service.

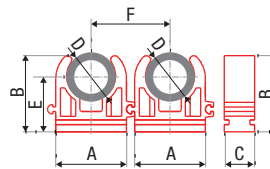

QTY	⊕	⊞	⊠	⊡	dm ²	# ●	# ●	A [mm]	B [mm]	C [mm]	E [mm]	F [mm]
16	pcs	750	50	0,02	0,03	AA976016001	WA976016001	33,7	29,9	15,7	24,2	30,0
20	pcs	400	50	0,03	0,05	AA976020001	WA976020001	30,0	32,3	16,0	24,4	34,5
25	pcs	400	50	0,05	0,06	AA976025001	WA976025001	35,3	38,0	16,0	28,0	39,5

Plastic double clip PP

System: **FV AQUA**

Material: PPR

Standard: -

Details: Plastic clip for sliding point of parallel pipe on the wall.

Note: When ordering the black color of the clip, replace the AA ... for BB ..., or contact the customer service.

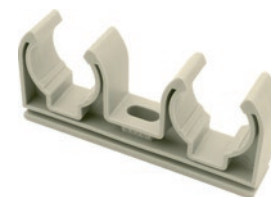
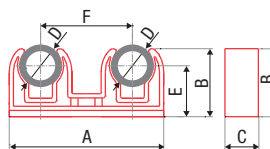

QTY	⊕	⊞	⊠	⊡	dm ²	# ●	# ●	A [mm]	B [mm]	C [mm]	E [mm]	F [mm]
2 × 16	pcs	500	50	0,01	0,04	AA976016002	WA976016002	65,3	30,2	15,9	24,2	40,4
2 × 20	pcs	450	50	0,02	0,05	AA976020002	WA976020002	70,5	34,8	15,9	25,5	43,4
2 × 25	pcs	200	50	0,03	0,06	AA976025002	WA976025002	89,0	40,0	15,8	27,8	54,7

Plastic clip with stirrup

System: **FV AQUA**

Material: PPR

Standard: -

Details: Plastic clip with stirrup for sliding point of pipe on the wall and ceiling.

Note: When ordering the black color of the clip, replace the AA ... for BB ..., or contact the customer service.

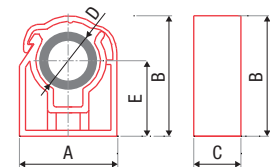

QTY	⊕	⊞	⊠	⊡	dm ²	# ●	# ●	A [mm]	B [mm]	C [mm]	E [mm]
15	pcs	600	50	0,01	0,03	AA977015001	WA977015001	25,0	33,5	16,0	22,5
16	pcs	600	50	0,01	0,03	AA977016001	WA977016001	26,0	34,0	16,0	23,0
18	pcs	600	50	0,01	0,03	AA977018001	WA977018001	28,0	36,5	16,0	24,0
20	pcs	400	50	0,02	0,04	AA977020001	WA977020001	31,0	38,0	16,0	25,0
22	pcs	400	50	0,02	0,04	AA977022001	WA977022001	33,0	40,5	16,0	26,0
25	pcs	400	50	0,02	0,04	AA977025001	WA977025001	35,0	43,5	16,0	28,0

Plastic double clip with stirrup

System: **FV AQUA**

Material: PPR

Standard: -

Details: Plastic clip with stirrup for sliding point of parallel pipe on the wall and ceiling.

Note: When ordering the black color of the clip, replace the AA ... for BB ..., or contact the customer service.

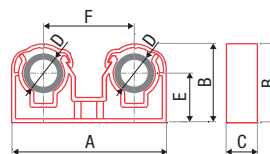

QTY	⊕	⊞	⊠	⊡	dm ²	# ●	# ●	A [mm]	B [mm]	C [mm]	E [mm]	F [mm]
15	pcs	200	50	0,02	0,06	AA977015002	WA977015002	61,2	33,5	16,0	22,5	36,2
18	pcs	300	50	0,02	0,06	AA977018002	WA977018002	70,2	36,5	16,0	24,0	42,2
20	pcs	300	50	0,04	0,08	AA977020002	WA977020002	76,2	38,0	16,0	25,0	45,2
22	pcs	300	50	0,04	0,08	AA977022002	WA977022002	81,2	40,5	16,0	26,0	48,2
25	pcs	150	50	0,04	0,08	AA977025002	WA977025002	90,2	43,5	16,0	28,0	55,2

Spacing clip for cold water

System: **FV AQUA**

Material: PPR

Standard: -

Details: Universal plastic clip for sliding point of pipes of different diameters on the wall and ceiling.

Note: When ordering the black color of the clip, replace the AA ... for BB ..., or contact the customer service.

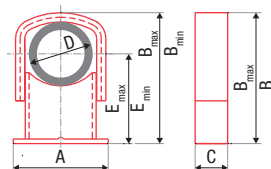

						#	#	A [mm]	B _{min} [mm]	B _{max} [mm]	C [mm]	E _{max} [mm]	E [mm]
16-25	pcs	200	50	0,01	0,05	AA978016025	WA978016025	43,2	42,0	51,5	29,5 (32)	30,0	34,5
25-50	pcs	50	25	0,05	0,20	AA978025050	WA978025050	70,2	76,5	101,5	35,4 (38)	56,5	69,0

Plastic clip with strap

System: **FV AQUA**

Material: -

Standard: -

Details: Reliable clip with strap for sliding point of pipe on the wall and ceiling.

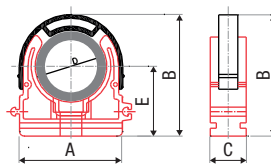

						#	A [mm]	B [mm]	C [mm]	E [mm]
32	pcs	400	50	0,02	0,05	AA979032000	52,5	54,7	15,8	31,8
40	pcs	300	50	0,03	0,06	AA979040000	63,4	63,6	15,8	36,6
50	pcs	150	25	0,04	0,16	AA979050000	80,2	77,0	18,7	40,4
63	pcs	100	25	0,05	0,19	AA979063000	96,3	91,0	18,9	46,6
75	pcs	60	1	0,10	0,38	AA979075000	120,1	90,6	24,1	62,5
90	pcs	40	1	0,12	0,50	AA979090000	138,7	129,3	24,2	68,3
110	pcs	30	1	0,15	0,64	AA979110000	164,0	149,2	24,0	78,3

Metal sleeve

System: **FV AQUA**

Material: -

Standard: -

Details: For fixing point, also suitable for vertical pipeline. Creates a fixing point - must be taken into account when planning compensation.



						#				
20	pcs	100	1	0,04	0,04	AA980020000				
25	pcs	100	1	0,04	0,04	AA980025000				
32	pcs	100	1	0,05	0,05	AA980032000				
40	pcs	100	1	0,06	0,06	AA980040000				
50	pcs	50	1	0,07	0,16	AA980050000				
63	pcs	50	1	0,11	0,19	AA980063000				
75	pcs	50	1	0,16	0,38	AA980075000				
90	pcs	50	1	0,19	0,50	AA980090000				
110	pcs	50	1	0,25	0,64	AA980110000				

Screw combi

System: **FV AQUA**

Material: -

Standard: -

Details: Screw for metal sleeve.



						#				
M8 x 100	pcs	100	1	0,04	0,04	AA981008100				

Dowels

System: **FV AQUA**

Material: PPR

Standard: -

Details: High quality dowels with square cross section and thick wall.

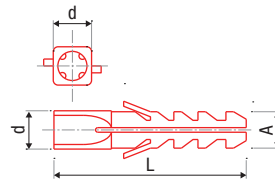

mm	pcs	mm	mm	mm	mm	#	A [mm]	d [mm]	L [mm]
6 mm	pcs	800	20	0,01	0,03	AA982006000	5,6	6	30
8 mm	pcs	480	20	0,02	0,04	AA982008000	7,5	8	40
10 mm	pcs	170	10	0,03	0,07	AA982010000	9,5	10	50
12 mm	pcs	120	10	0,04	0,13	AA982012000	11,7	12	60

Threaded bar

System: **FV AQUA**

Material: Galvanized steel

Standard: -

Details: Threaded bar made from quality galvanized steel.

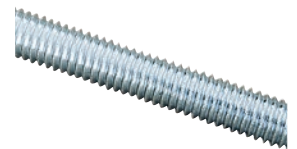

mm	pcs	mm	mm	mm	mm	#			
M8 x 1000 mm	pcs	50	1	0,04	0,33	AA983008000			

Clamping strap

System: **FV AQUA**

Material: -

Standard: -

Poznámka: Universal strap for binding pipes together.



mm	pcs	mm	mm	mm	mm	#			
7,6 x 400	pcs	100	1	0,01	0,01	AA984000000			

Plastic trough

System: **FV AQUA**

Material: PVC - RE

Standard: -

Details: Perspective plastic trough from PVC suitable for lead the pipes. Standard length 4m.

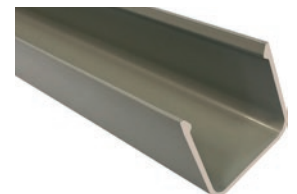

mm	m	mm	mm	[kg/bm]	[bm/dm3]	#			
120 x 100 x 4000 mm	m	1	1	1,75	12	AA985012004			

Trough cover plastic

System: **FV AQUA**

Material: PVC - RE

Standard: -

Details: Cover for trough with reliable set system. Standard length 1m. Color grey.

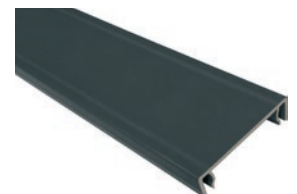

mm	m	mm	mm	[kg/bm]	[bm/dm3]	#			
146 x 30 x 1000 mm	m	1	1	1,3	4,38	AA986013001			

Galvanized trough (2 m length)

System: **FV AQUA**
 Material: -
 Standard: -
 Details: Trough for a supporting lead of a pipe in spaces where you can not use clips.



						#			
16 × 2 m	pcs	25	2	0,29	0,26	AA987026002			
20 × 2 m	pcs	25	2	0,34	0,40	AA987020002			
25 × 2 m	pcs	25	2	0,44	0,63	AA987025002			
32 × 2 m	pcs	25	2	0,53	1,02	AA987032002			
40 × 2 m	pcs	20	2	0,62	1,60	AA987040002			
50 × 2 m	pcs	20	2	0,76	2,50	AA987050002			
63 × 2 m	pcs	15	2	0,90	3,97	AA987063002			
75 × 2 m	pcs	15	2	1,07	5,63	AA987075002			
90 × 2 m	pcs	10	2	1,11	5,63	AA987090002			

RPE pipe

System: **FV AQUA**
 Material: RPE
 Standard: -
 Details: Special pipe for connection to the flushing systems etc.



						#			
10/6	kg	1	1	1,00		AA988000000			

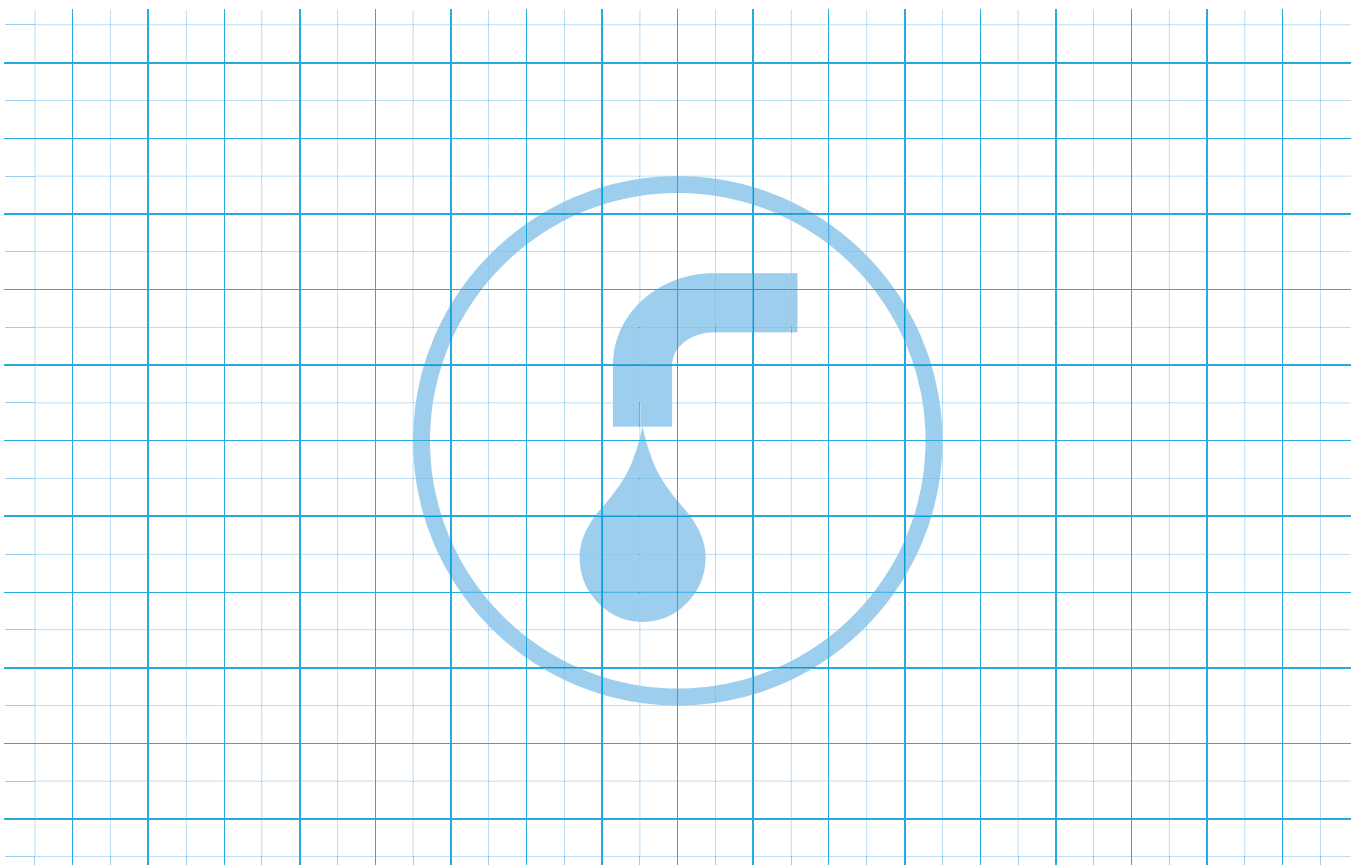



FV
PLAST®



SYSTEM PIPES FOR HEATING

FV MULTIPERT-5

System: **FV THERM**

Material: PE-RT/EVOH/PE-RT

Standard: EN ISO 22391, DIN 4726

Five-layer, highly flexible polyethylene pipe PE-RT II with high heat resistance (acc. to EN ISO 22391), with an oxygen barrier of ethylene vinyl alcohol (EVOH) according to DIN 4726. T_{max} 95°C.

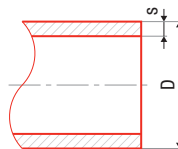

						#	D [mm]	s [mm]	l [mm]
8 × 1,0	m	200	cardboard	0,06	0,60	AA120008200	8	1,0	200
8 × 1,0	m	400	foil	0,06	0,60	AA120008400	8	1,0	400
10 × 1,3	m	200	cardboard	0,06	0,60	AA120010200	10	1,3	200
10 × 1,3	m	400	foil	0,06	0,60	AA120010200	10	1,3	400
12 × 1,5	m	200	cardboard	0,07	0,60	AA120012200	12	1,5	200
12 × 1,5	m	400	foil	0,07	0,60	AA120012400	12	1,5	400
14 × 1,8	m	200	cardboard	0,07	0,60	AA120014200	14	1,8	200
14 × 1,8	m	300	cardboard	0,07	0,60	AA120014300	14	1,8	300
14 × 1,8	m	400	foil	0,07	0,60	AA120014400	14	1,8	400
15 × 1,8	m	200	cardboard	0,08	0,60	AA120015200	15	1,8	200
15 × 1,8	m	400	foil	0,08	0,60	AA120015400	15	1,8	400
16 × 2,0	m	200	cardboard	0,09	0,60	AA120016200	16	2,0	200
16 × 2,0	m	400	foil	0,09	0,60	AA120016400	16	2,0	400
17 × 2,0	m	200	cardboard	0,09	0,60	AA120017200	17	2,0	200
17 × 2,0	m	400	foil	0,09	0,60	AA120017400	17	2,0	400
18 × 2,0	m	200	cardboard	0,108	0,60	AA120018200	18	2,0	200
18 × 2,0	m	400	foil	0,108	0,60	AA120018400	18	2,0	400
20 × 2,0	m	200	cardboard	0,09	0,60	AA120020200	20	2,0	200

FV MULTIPEX-5

System: **FV THERM**

Material: PE-Xa/EVOH/PE-Xa

Standard: ČSN EN ISO 15875, DIN 4726

Five-layer, particularly resistant pipe of cross-linked polyethylene PE-Xa with increased heat resistance (acc. to ČSN EN ISO 15875), with an oxygen barrier of EVOH according to DIN 4726. T_{max} 110°C.

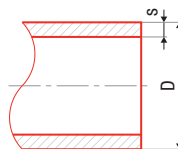

						#	D [mm]	s [mm]	l [mm]
16 × 2,0	m	200	cardboard	0,09	0,60	AA121016200	16	2,0	200
16 × 2,0	m	400	foil	0,09	0,60	AA121016400	16	2,0	400
17 × 2,0	m	200	cardboard	0,10	0,60	AA121017200	17	2,0	200
17 × 2,0	m	400	foil	0,10	0,60	AA121017400	17	2,0	400
20 × 2,0	m	200	cardboard	0,11	0,60	AA121020200	20	2,0	200

FV MULTIPERT-AL

System: **FV THERM**

Material: PE-RT/AL/PE-RT

Standard: ČSN EN ISO 15874, DIN 8077, DIN 8078

Five-layer, polyethylene pipe PE-RT II with an longitudinally welded aluminium layer. Increased heat resistance (acc. to EN ISO 22391). Oxygen barrier of aluminum according to DIN 4726. T_{max} 95°C.

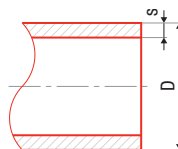

						#	D [mm]	s [mm]	l [mm]
16 × 2,0	m	200	cardboard	0,112	0,60	AA130016200	16	2,0	200
16 × 2,0	m	400	foil	0,112	0,60	AA130016400	16	2,0	400
18 × 2,0	m	200	cardboard	0,136	0,60	AA130018200	18	2,0	200
20 × 2,0	m	200	cardboard	0,154	0,60	AA130016200	20	2,0	200

FV MULTIPEX-AL

System: **FV THERM**

Material: PE-Xb/AL/PE-Xb

Standard: ČSN EN ISO 15874, DIN 8077, DIN 8078

Five-layer, particularly resistant pipe of cross-linked polyethylene PE-Xb with an longitudinally welded aluminium layer. Increased heat resistance (acc. to ČSN EN ISO 15875. Oxygen barrier of aluminium according to DIN 4726. Tmax 110°C

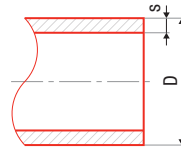

						#	D [mm]	s [mm]	l [mm]
16 × 2,0	m	200	cardboard	0,097	0,60	AA131016200	16	2,0	200
16 × 2,0	m	400	foil	0,097	0,60	AA131016400	16	2,0	400
18 × 2,0	m	200	cardboard	0,118	0,60	AA131018200	18	2,0	200
20 × 2,0	m	200	cardboard	0,142	0,60	AA131016200	20	2,0	200

SYSTEM PLATES

FV EPS insulated mounting mate in roll

System: **FV THERM**

Material: EPS

Standard: EN 13163

Heat and sound insulation EPS base (according to DIN EN 13163) (WLS 045) with a grid patterned durable waterproof polyethylene membrane to prevent water and humidity leak. Grid enables easy pipe fixing with tacker staples.

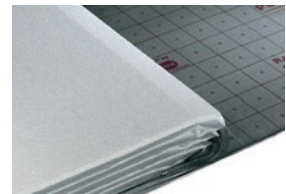

					#	for Ø D	pitch [mm]	netto area [m²/pcs]	capacity [kN/m²]	therm. con. [W/m.K]
1 × 10m × 30mm	m²	10	0,6	36,18	AA900010030	14 - 20		1,00	4	0,04

FV NOP UNI system mat

System: **FV THERM**

Material: PS

Standard: EN 13163

Universal mat of durable PS film with studs. For heating pipes with diameters 14, 15, 16, 17, 20mm. Enables 38mm or 75mm spacing. Special rim for easy connection of mats.

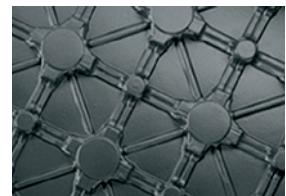

					#	for Ø D	pitch [mm]	netto area [m²/pcs]	capacity [kN/m²]	therm. con. [W/m.K]
1275 × 975 × 23mm	pcs	18	1,31	18,20	AA901001000	14 - 20	75/38	1,08	unlimited	

FV NOP SOLO system mat

System: **FV THERM**

Material: PS

Standard: EN 13163

Universal mat of PS film with studs. For heating pipes with diameters of 14, 15, 16, 17mm. Enables 60mm or 84mm spacing. Special rim for easy connection of mats.

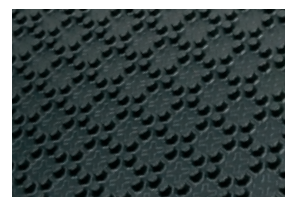

					#	for Ø D	pitch [mm]	netto area [m²/pcs]	capacity [kN/m²]	therm. con. [W/m.K]
1025 × 1025 × 17mm	pcs	20	0,975	10,92	AA902001000	14 - 17	50/70	1,00	unlimited	

FV NOP ISO system mat with 11 mm insulation

System: **FV THERM**

Material: EPS/PS

Standard: EN 13163

Combined thermal and sound insulation of EPS 11 mm with a layer resistant to deep-drawn PS foil formed into the shape of studs. A suitable mat for heating pipes with diameters of 14, 15, 16, 17 mm, with a rim for easy connection to other mats. System mat for floor heating allows quick and easy installation with minimum of pruning.



Image	Symbol	Symbol	Symbol	Symbol	#	for Ø D	pitch [mm]	netto area [m²/pcs]	capacity [kN/m²]	therm.con. [W/m.K]
1025 × 1025 × 11mm	pcs	10	1,3	21,84	AA902001011	14 - 17	50/70	1,00	4,6	0,035

FV NOP ISO PLUS system mat with 30 mm insulation

System: **FV THERM**

Material: EPS/PS

Standard: EN 13163

Combined thermal and sound insulation of EPS 30 mm with a layer resistant to deep-drawn PS foil formed into the shape of studs. A suitable mat for heating pipes with diameters of 16 -18 mm, with a rim for easy connection to other mats. System mat for floor heating allows quick and easy installation with minimum of pruning.



Image	Symbol	Symbol	Symbol	Symbol	#	for Ø D	pitch [mm]	netto area [m²/pcs]	capacity [kN/m²]	therm.con. [W/m.K]
1400 × 800 × 30mm	pcs	8	1,75	57,08	AA902001030	16 -18	50	1,12	5	0,035

FV TBS system mat with 25 mm insulation for dry construction

System: **FV THERM**

Material: EPS

Standard: EN 13163

A special system for dry construction of floor heating. Thermal insulation board made of 25 mm EPS for inserting guide plates and reversing arcs. A suitable mat for heating pipes with diameter 14 mm, with a rim for easy connection to other mats. System mat for floor heating allows quick and easy installation with minimum of pruning.



Image	Symbol	Symbol	Symbol	Symbol	#	for Ø D	pitch [mm]	netto area [m²]	capacity [kN/m²]	therm.con. [W/m.K]
1020 × 645 × 25 mm	pcs	21	0,476	17,35	AA903001025	14	125	0,625	6	0,035

FV TBSL guide plate

System: **FV THERM**

Material: Fe/Zn

Standard: -

Metallic guide plate insert to FV THERM TBS system mat. For heating pipes with 14mm diameter



Image	Symbol	Symbol	Symbol	Symbol	#	for Ø D	rozteče [mm]			
750 × 120 mm	pcs	50	0,44	0,466	AA903002000	14	125			

FV TBSC reversing arc for mats FV TBS

System: **FV THERM**

Material: Fe/Zn

Standard: -

Metallic arc insert to FV THERM TBS system mat. For heating pipes with 14mm diameter.



Image	Symbol	Symbol	Symbol	Symbol	#	for Ø D	pitch [mm]			
245 × 125 mm	pcs	25	0,141	0,466	AA903003000	14	125			

FV RENO special mat for floor reconstruction

System: **FV THERM**

Material: PS

Standard: EN 13163

A low-height mat made of PS with studs. Designed for the floor heating instalations on original old floors. For heating pipes with diameter of 10-12mm.

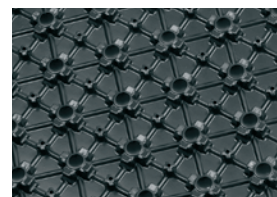

					#	for Ø D	pitch [mm]	netto area [m ² /pcs]	capacity [kN/m ²]	therm.con. [W/m.K]
1050 × 650 × 16 mm	pcs	16	0,84	11,44	AA904001000	10 - 12	50/43	0,60	unlimited	

FV clamping rail

System: **FV THERM**

Material: PP

Standard: -

A Clamping rail for easy laying of system pipes with height fixation and adhesive tape for quick fixing to the base. Minimum span of pipes 50 mm, length 1000 mm. Universal for pipes with diameters of 16-20 mm.

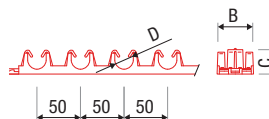

					#	D [mm]	B [mm]	C [mm]
16 - 20 × 1000 mm	pcs	100	1,68	0,83	AA905003000	16 - 20	40	28

FV staple for clamping rail

System: **FV THERM**

Material: PP

Standard: -

Staple for fixing a universal clamping rails. Staple securely holds the clamping rail in the EPS mats even when used in dusty spaces. It delivers in white color.

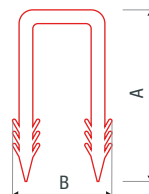

					#	D [mm]	A [mm]	B [mm]
	pcs	200	0,002	0,009	AA9090000058		58	27

MANIFOLD

FV manifold with flowmeter

System: **FV THERM**
 Material: brass
 Standard: -

Complete heating manifold with flowmeters. Distributor and collector are made of 50mm diameter solid brass profiles with 1" AG connections, optionally left or right. The distributor is equipped with adjustable and lockable, always clear, dry flow meters with a scale of 0.1 to 4 l/min for precise tuning of the water flow into the individual heating sections. The collector is equipped with shut-off valves ready for the usage of termodrives with ON/OFF function. The distributor and collector are mounted on a soundproof concole at different depth for easier connection of the pipes.

The set includes the filling and drain ball valves with 1/2" connection, manual air bleeding valves, labels.

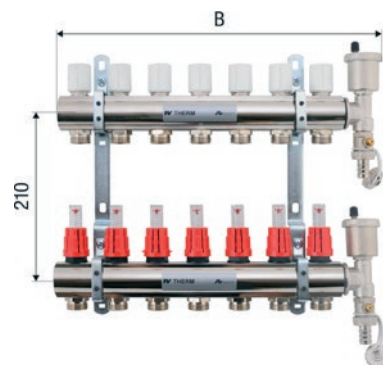

Icon	⊕	⊞	🏠	📏	dm³	#		B [mm]	
150 mm	pcs	1		1,50	6,00	AA906000002	2 circuits	150	
200 mm	pcs	1		1,80	6,00	AA906000003	3 circuits	200	
250 mm	pcs	1		2,00	6,00	AA906000004	4 circuits	250	
300 mm	pcs	1		2,50	8,00	AA906000005	5 circuits	300	
350 mm	pcs	1		3,00	8,00	AA906000006	6 circuits	350	
400 mm	pcs	1		3,50	8,00	AA906000007	7 circuits	400	
450 mm	pcs	1		4,00	10,00	AA906000008	8 circuits	450	
500 mm	pcs	1		4,50	10,00	AA906000009	9 circuits	500	
550 mm	pcs	1		5,00	10,00	AA906000010	10 circuits	550	
600 mm	pcs	1		5,50	10,00	AA906000011	11 circuits	600	
650 mm	pcs	1		6,00	10,00	AA906000012	12 circuits	650	

FV manifold INOX

System: **FV THERM**
 Material: brass
 Standard: -

Complete heating manifold with flowmeters. Distributor and collector are made of 50mm diameter solid brass profiles with 1" AG connections, optionally left or right with automatic venting and ball valve 1/2" for filling and draining. The distributor is equipped with adjustable and lockable, always clear, dry flow meters with a scale of 0.1 to 4 l/min for precise tuning of the water flow into the individual heating sections. The collector is equipped with shut-off valves ready for the usage of termodrives with ON/OFF function.

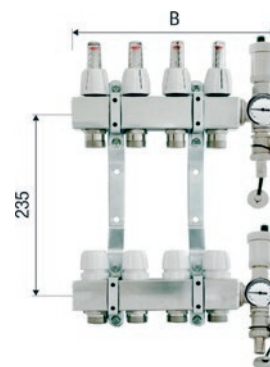

Icon	⊕	⊞	🏠	📏	dm³	#		B [mm]	
150 mm	pcs	1		2,8	10,10	AA906001002	2 circuits	150	
200 mm	pcs	1		3,3	10,10	AA906001003	3 circuits	200	
250 mm	pcs	1		3,7	10,10	AA906001004	4 circuits	250	
300 mm	pcs	1		4,2	12,50	AA906001005	5 circuits	300	
350 mm	pcs	1		4,6	14,90	AA906001006	6 circuits	350	
400 mm	pcs	1		5,0	14,90	AA906001007	7 circuits	400	
450 mm	pcs	1		5,5	17,30	AA906001008	8 circuits	450	
500 mm	pcs	1		5,9	17,30	AA906001009	9 circuits	500	
550 mm	pcs	1		6,3	19,70	AA906001010	10 circuits	550	
600 mm	pcs	1		6,8	19,70	AA906001011	11 circuits	600	
650 mm	pcs	1		7,1	19,70	AA906001012	12 circuits	650	

MIXING SETS

FV mixing set for 200 m²

System: **FV THERM**
 Material: brass
 Standard: -

Mixing set for underfloor heating with heating surface up to 200 m². The set contains thermoregulation valve, thermostatic head with thermal range 20 - 43°C., sensor, circulation pump Wilo Star RS 15/6, three-way valve, By-pass, thermometer in the manifold inlet. Connection 1".

	pcs	1	4,1	10,5	AA906100200	B [mm] 219

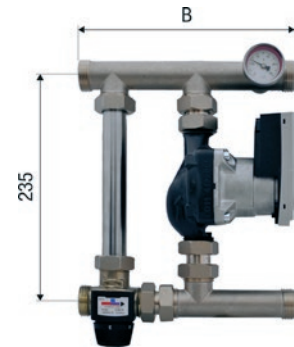

FV mixing set for 160 m²

System: **FV THERM**
 Material: brass
 Standard: -

Mixing set for underfloor heating with heating surface up to 160 m². The set contains thermoregulation valve, thermostatic head with thermal range 20-65 °C, sensor, circulation pump Wilo STar RS 15/6, back flow valve, By-pass regulation valve, electronic control unit of pump, thermometer. Connection 1"

	pcs	1	4,5	12,7	AA906100160	B [mm] 194

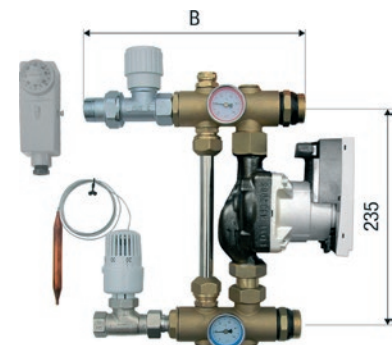

VALVES AND A THERMOMETERS

FV ball valve 1" with male and female thread

System: **FV THERM**
 Material: Forged brass body according to EN 12165, nickel.
 Standard: ČSN EN ISO 228
 Ball valve with connection 1" and colored butterfly handle.
 Field of use -10 °C to +95°C.

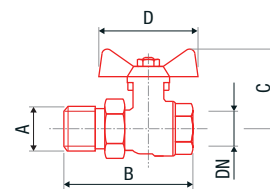

1"	pcs	72	6	0,53	0,36	AA926001001	#	A [mm] 1"	B [mm] 88	C [mm] 57	D [mm] 67
1"	pcs	72	6	0,53	0,36		AA926001002				

FV thermometer for manifold

System: **FV THERM**
 Material: -
 Fixing: On the body of manifold
 Thermometer for measuring input and output temperature on manifold. Field of use min. 0 °C to 120 °C.

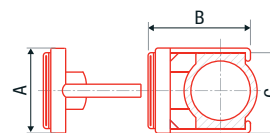

1"	pcs		1	0,53	0,09	AA927000001	#	A [mm] Ø 45,5	B [mm] 55	C [mm] 40,8
1"	pcs		1	0,53	0,09		AA927000002			

BOXES

FV manifold cabinet on plaster

System: **FV THERM**

Material: -

Standard: -

Made of steel sheet, covered with white paint. Rear panel with supporting arm for mounting the distributor, depth 130mm, removable and lockable door.



QTY	⊕	⊞	⊠	⊡	dm	#			
450 mm	pcs	1	1	5,80	39,00	AA907000045			
530 mm	pcs	1	1	6,20	46,00	AA907000053			
680 mm	pcs	1	1	7,50	59,00	AA907000068			
830 mm	pcs	1	1	9,20	72,00	AA907000083			
1030 mm	pcs	1	1	10,00	89,00	AA907000103			

FV manifold cabinet under plaster

System: **FV THERM**

Material: -

Standard: -

Made of steel sheet, covered with white paint. Rear panel with supporting arm for mounting the distributor, the depth of 100mm. Adjustable above-floor height. Removable and lockable door.



QTY	⊕	⊞	⊠	⊡	dm	#			
450 mm	pcs	1	1	6,10	41,00	AA908000045			
530 mm	pcs	1	1	6,70	47,00	AA908000053			
680 mm	pcs	1	1	7,80	60,00	AA908000068			
830 mm	pcs	1	1	9,90	72,00	AA908000083			
1030 mm	pcs	1	1	11,00	89,00	AA908000103			

ACCESSORIES

FV tacker staple

System: **FV THERM**

Material: -

Standard: -

High quality harpoon-shaped staples for fixing 15 - 20mm pipes onto the FV THERM EPS system roll. Stacked by 50pcs for easy staple gun filling.



QTY	⊕	⊞	⊠	⊡	dm	#			
40 mm	pcs	1	300	0,0018	0,010	AA909000040			
50 mm	pcs	1	250	0,0021	0,013	AA909000050			

FV edge belt

System: **FV THERM**

Material: -

Standard: -

Special mounting area edge belt made of 8mm thick and 150mm height polyethylene foam (PE) with 280mm wide polyethylene film attached.

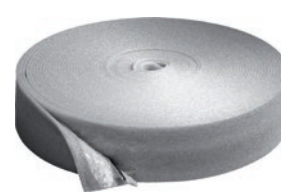

QTY	⊕	⊞	⊠	⊡	dm	#			
150 mm	m	400	50	1,00	15,00	AA910150050			

FV PE protecting tube

System: **FV THERM**

Material: PE

Standard: -

Polyethylene (PE) protective tube designed to protect the heating pipes running through the dilatation joints and to the manifold.



						#			
24 mm x 50 m	pcs		50 m	6,00	0,35	AA911024050			

FV dilatation belt

System: **FV THERM**

Material: -

Standard: -

For safe separation of dilatating floor segment and creating long elastic dilatation joints. Made of 10mm thick polyethylene foam (PE) core, height 100mm, length 2000mm.



						#			
100 x 2000 mm	m	220	2	0,07	2,236	AA912100200			

FV direction diverter

System: **FV THERM**

Material: -

Standard: -

Direction diverter adjustable 0 - 90°. Designed to divert the heating pipes passing through the ceiling or rising to the manifold.



						#	D [mm]	length [mm]	
20	pcs	50	1	0,056	0,64	AA913020000	20	250	

FV direction diverter "click"

System: **FV THERM**

Material: -

Standard: -

A direction diverter click 0 - 90° for protection and fixing pipes to pass trough ceiling and input to manifold.



						#	D [mm]	délka [mm]	
15	pcs	25	1	0,060	0,116	AA913015000	15	150	
16 - 17	pcs	25	1	0,060	0,122	AA913017000	16 - 17	153	
18 - 20	pcs	25	1	0,060	0,122	AA913020000	18 - 20	175	

FV fixing plastic bend

System: **FV THERM**

Material: -

Standard: -

A bend 90° for protection and fixing pipes to pass trough ceiling and input to manifold. Universal for diameters 14 - 18 mm and 20 - 22 mm.



						#	D [mm]	length [mm]	
14 - 18	pcs	400	1	0,035	0,186	AA913014018	14 - 18	160	
20 - 22	pcs	400	1	0,035	0,186	AA913014022	20 - 22	160	

FV self-adhesive tape

System: **FV THERM**

Material: -

Standard: -

Durable self-adhesive tape 50mm width, 60m length.



QTY	⊕	⊞	⊠	⊡	⊣	#			
50 mm x 60 m	pcs	10	1	0,01	0,10	AA914050060			

FV screed plasticizer

System: **FV THERM**

Material: -

Standard: -

A special additive for preparing the screed with good elasticity and high mechanical strength.



QTY	⊕	⊞	⊠	⊡	⊣	#			
5 l	pcs		1	5,00	5,00	AA915005000			

CONTROL

FV servodrive

System: **FV THERM**

Material: -

Standard: -

For heating systems with thermostatic control. Designed for integration into the heating valve (in the manifold) with position indicator "open / closed".



QTY	⊕	⊞	⊠	⊡	⊣	#			
230 V	pcs	50	1	0,14	0,30	AA916000000			

FV thermostatic controller

System: **FV THERM**

Material: -

Standard: -

Electronic single room temperature controller. To be used in combination with servo drives.



QTY	⊕	⊞	⊠	⊡	⊣	#			
230 V	pcs		1	0,20	0,10	AA917000000			

FV electronic switching module

System: **FV THERM**

Material: -

Standard: -

Electronic switching module for connecting up to 24 servodrives and 6 thermostatic controllers. To be mounted on DIN rail.



QTY	⊕	⊞	⊠	⊡	⊣	#			
24 - 230V	pcs		1	0,40	3,00	AA918000000			

FV transformer 230/24 V

System: **FV THERM**

Material: -

Standard: -

Safety transformer 230 V AC / 24V AC. Short-circuit protection, with built-in thermal fuse.



						#			
230/24V	pcs	1	2,00	1,00	AA919000000				

FV flowmeters

System: **FV THERM**

Material: -

Standard: -

Safety transformer 230 V AC / 24V AC. Short-circuit protection, with built-in thermal fuse.



					#	A [mm]	B [mm]	C [mm]
	pcs	1	0,038	0,014	AA906999000	1/2"	7	100

JOINS

FV transition union to the distributor (Eurocone 3/4")

System: **FV THERM**

Material: -

Standard: -

Threaded connector for connecting FV MULTIPERT and FV MULTIPEX heating pipes to the manifold.



						#			
10 × ..	pcs	10	0,10	0,03	AA920010000				
12 × ..	pcs	10	0,10	0,03	AA920012000				
14 × 1,8	pcs	10	0,081	0,045	AA920014000				
15 × 1,8	pcs	10	0,10	0,03	AA920015000				
16 × 2,0	pcs	10	0,10	0,03	AA920016000				
17 × 2,0	pcs	10	0,10	0,03	AA920017000				
18 × 2,0	pcs	10	0,10	0,03	AA920018000				
20 × 2,0	pcs	10	0,10	0,03	AA920020000				

FV coupling

System: **FV THERM**

Material: -

Standard: -

Reliable brass coupling. It consists of a dual MS threaded connection and two transition unions for connecting the pipes.



Q.tà	⊕	⊞	⊞	⊞	dm	#			
10 x ..	pcs			10	0,10	0,07	AA921010000		
12 x ..	pcs			10	0,10	0,07	AA921012000		
14 x 1,8	pcs			10	0,10	0,07	AA921014000		
15 x 1,8	pcs			10	0,10	0,07	AA921015000		
16 x 2,0	pcs			10	0,10	0,07	AA921016000		
17 x 2,0	pcs			10	0,10	0,07	AA921017000		
18 x 2,0	pcs			10	0,10	0,07	AA921018000		
20 x 2,0	pcs			10	0,10	0,07	AA921020000		

FV reducing sleeve male 3/4"

System: **FV THERM**

Material: brass - nickel

Reducing sleeve for connection of MULTI pipes to transition union Euroconus 3/4". Field of use min. 0 °C - 95 °C

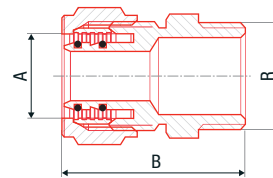

Q.tà	⊕	⊞	⊞	⊞	dm	#	A	B [mm]	R
15 x 3/4"	pcs	1	1	0,085	0,135	AA924015034	15	38	3/4"
16 x 3/4"	pcs	1	1	0,088	0,135	AA924016034	16	40	3/4"
17 x 3/4"	pcs	1	1	0,090	0,135	AA924017034	17	40	3/4"
20 x 3/4"	pcs	1	1	0,111	0,135	AA924020034	20	43	3/4"

FV plug female 3/4"

System: **FV THERM**

Material: brass - nickel

Fixing: closing branches of manifold

For closing non-use branches of manifold. the possibility of establishing reserves for future expansion. Field of use min. 0°C - 120°C.

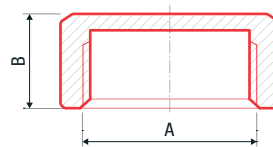

Q.tà	⊕	⊞	⊞	⊞	dm	#	A	B [mm]	
3/4"	pcs			1	0,034	0,027	AA925020034	3/4"	12

ACCESSORIES

FV Tacker - fixing gun

System: **FV THERM**

Material: -

Standard: -

Tucker 15 - 20 - special fixing tool for fixing pipes on the mats. Height-adjustable, for fixing pipes using the original harpoon-staples.



Q.tà	⊕	⊞	⊞	⊞	dm	#			
15 - 20	pcs			1	7,00	15,00	AA922000000		

FV Tacker - fixing gun plastic

System: **FV THERM**

Material: -

Standard: -

Tucker 15 - 20 - special fixing tool for fixing pipes on the mats. Height-adjustable, for fixing pipes using the original harpoon-staples.



15 - 20	pcs		1	1,75	22,30	AA922000001			

FV horizontal decoiler

System: **FV THERM**

Material: Fe - galvanized iron

Standard: -

For unwinding of the heating pipes up to the length of 600 meters. Maximum load 90kg, the maximum coil diameter of about 260mm, a maximum width of 420mm.



14 - 20	pcs		1	16,00	45,29	AA923001000	Ø [mm]	výška [mm]	
							1140	548	



ASSEMBLY INSTRUCTIONS

FV Therm underfloor heating system is designed for apartments, family houses, administrative and shopping centers and industrial buildings heating. The system is based on FV MULTIPERT-5 and FV MULTIPLEX-5 quality pipes with EVOH oxygen barrier specially designed for the underfloor heating, their usage is the most economic for this purpose. FV MULTIPERT-AL or FV MULTIPLEX-AL with a lengthwise welded aluminium layer quality pipes can be used as well.

The FV THERM underfloor heating system is classified as a system for flooring in wet conditions in a construction implementation A group as per DIN 18560-2 on the basis of the arrangement of FV MULTIPLEX-5 and FV MULTIPERT-5 heating pipes on an insulation layer.

Figure 1: Construction implementation A - Pipes in topping systems

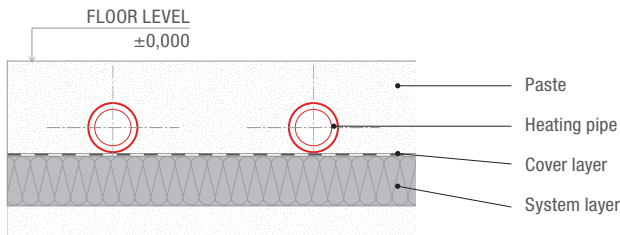
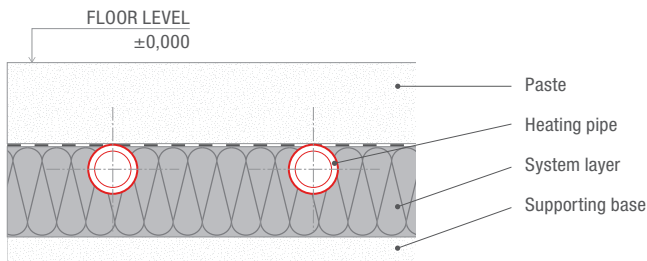

Figure 2: Construction implementation B - Pipes under topping systems



1. FIELDS AND DILATATION JOINT SIZES

A topping is realized as per DIN 18560-1. Topping additives can be used for a better cement toppings processing. The size of topping sand grains should be between 0 – 8 mm. Topping fields of 1:1 or 1:2 joints ratio should not exceed 40 m². See figure 3 for a dilatation fields and joints arrangement. Regarding the areas smaller than 40m², the dilatation joints should be used if the side size exceeds 8 m or the sticking out construction parts (corners, pillars, chimneys) limit the shape of a topping sheet.

The dilatation joints can be crossed using only connecting line in one level via a minimum of 200mm long protecting pipe for each joint side.

Three measure points are required for each topping area of 200m² to measure residual moisture. Heating circuit designing must have the size and shape of the topping sheet (see figure 3). Regarding the anhydrite poured toppings, the joint arrangement has to be consulted with a topping producer.

The construction joints and the joints in the topping (motion joints) and in the final flooring have to be done. The topping is separated from vertical construction parts by the joints (marginal joints). If the contraction joints are in the heating toppings, they can be notched to one third of topping size maximum. A joint plan about the joints arrangement has to be made to inform about the type and arrangement of joints. The plan is made by a construction draftsman and presented as a part of realizing company performance descriptions.

Figure 3: Fields and dilatation joints arrangement

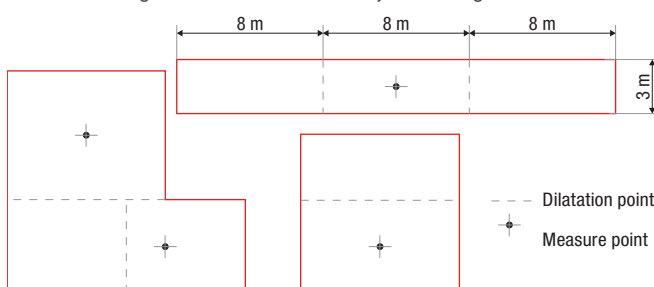

Figure 4: Heating paste dilatation joint

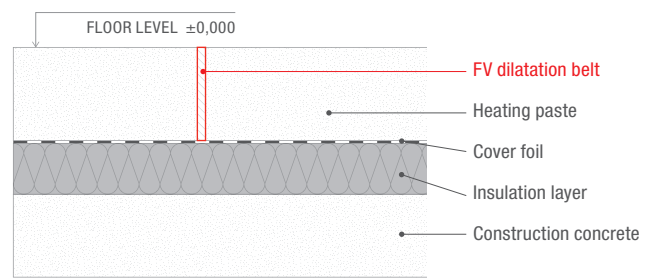

Figure 5: Heating paste dilatation belt when laying hard flooring (floor tiling, stone floor, laminate floor)

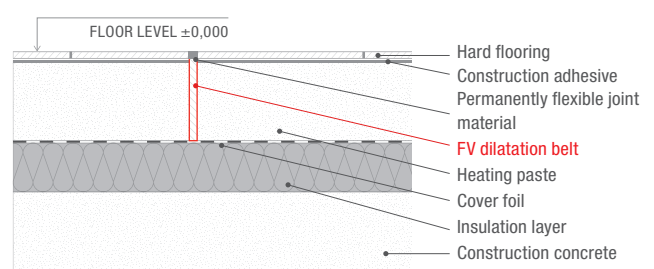

Figure 6: Heating paste dilatation belt when laying hard flooring with division layer (floor tiling, stone floor, laminate floor)

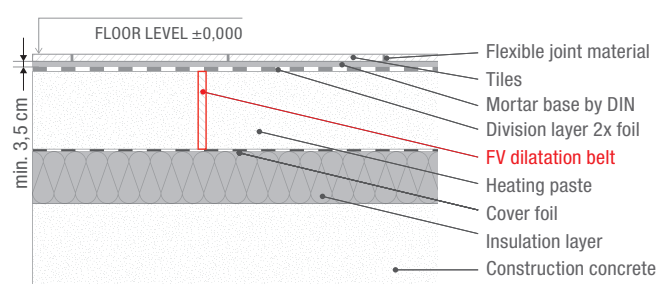
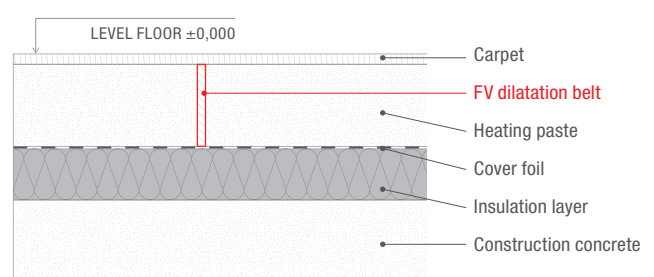

Figure 7: Heating paste dilatation belt when laying soft flooring (PVC, linoleum, carpet)



The dilatation joints are made in accordance with the joint plan. A construction dilatation joint is made without any cut also in the place of underfloor heating if there is one already. If the hard flooring is used, it is necessary to add the dilatation joint to this layer (see figure 5).

Protect the heating pipe when crossing danger zones (dilatation joints, door crossings, wall passages) by placing it into a FV PE protecting tube.

Only the intake and returnable pipes leading to individual circuits placed in sleeve can be put over the dilatation joint, not the circuit pipes. The minimum length of pipe sleeve (see figure 8) is 20cm on each dilatation joint side. The minimum width of the dilatation joint is 8mm.

Figure 8: Protection of heating pipe when crossing dilatation belt by FV PE protecting tube

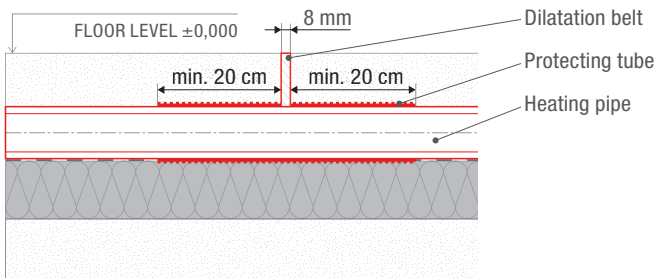

2. 2. UNDERFLOOR HEATING PIPES

FV MULTIPERT-5 and FV MULTIPLEX-5 pipes belong to high-quality, controlled and certified products. After receiving plastic pipes on a construction site, transport, store and process them so that:

- they are protected against any damage
- heating pipes are not under direct sunlight
- storage period does not exceed 3 months during unprotected storage
- they are stored on a flat base without any sharp edges
- they are protected against oils, fats, colors and longer effect of sunlight

Polyethylene heating pipes FV MULTIPERT-5

Permanent operating temperature:	+ 70°C
Maximal short-time thermal load:	+90°C (maximum of 2 years)
Operating pressure:	4bar
Meets all requirements of ISO 10508 norm for 4+5 class	
Minimal bend radius:	5 x r (r = inner diameter)
Installation temperature:	od -5°C to + 30°C
DIN Registration number:	3V 204 PE-RT

The 5-layer highly flexible PE-RT system pipe has enhanced thermal resistance as per EN ISO 22391, with the oxygen barrier as per DIN 4726, with enhanced protection against mechanical damage during transport and handling on the construction site. Package contains 200m in taped bundle in cartons. Package weight is approximately 25 kg.

The permeability of oxygen at 40°C is deep under DIN 4726 limit. Using the HP method, the EVOH barrier layer is inseparably connected to the PE-Xa basic pipe with enhanced thermal resistance, highly flexible, from a webbed polyethylene.

Polyethylene heating pipes FV MULTIPLEX-5

Permanent operating temperature:	+ 95°C
Maximal short-time thermal load:	+ 110°C (maximum of 2 years)
Operating pressure:	6bar
Meets all requirements of ISO 10508 norm for 4+5 class	
Minimal bend radius:	5 x r (r = inner diameter)
Installation temperature:	od -5°C do + 30°C
DIN Registration number:	3V 235 PE-Xa

The 5-layer highly flexible webbed polyethylene PE-Xa pipe has enhanced thermal resistance as per EN ISO 15875, with the oxygen barrier as per DIN 4726, with enhanced protection against mechanical damage during transport and handling on the construction site. Package contains 200 m in taped bundle in cartons. Package weight is approximately 25 kg.

The permeability of oxygen at 40°C is deep under DIN 4726 limit. Using the HP method, the EVOH barrier layer is inseparably connected to the basic pipe.

2.1. UNDERFLOOR HEATING ASSEMBLY STEPS IN FV THERM SYSTEM

Electric and sanitary installations, inner plasters and windows need to be finished before the installation of insulations and square heating. Plasters need to be plastered closely to the supportive base. An expert has to check the flatness of a row floor using a meter score before the installation of the underfloor heating system. Maximal altitude tolerance is 1cm on the entire installation room area. The meter scores are usually marked by a circle or other way at door spreads during the construction. Size tolerances are met as per DIN 18202 (ground constructions tolerance). The flatness needs to be checked before installing the insulation. Possible unevenness needs to be removed or flattened. The remaining plaster and other dirt need to be removed from the floor.

Figure. 9 Underfloor heating pipes layout

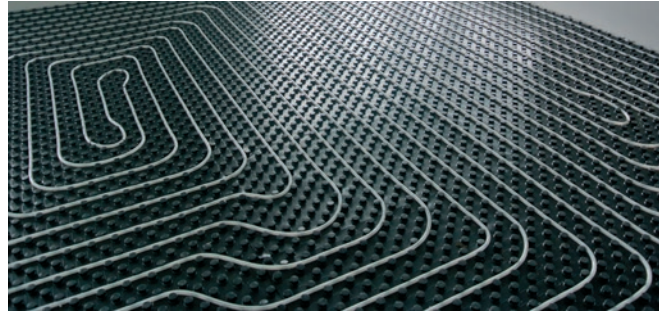

Ground bordering floor areas need to be insulated against moisture as per DIN 18195 (construction insulation). Accurate construction insulation execution definition is made by a draftsman or architect. A craftsman doing the insulation layout has to check sealing suitability and communicate in writing possible concerns about hydro insulation to construction administration. If a bitumen sealing assembly is done, of e.g. bitumen belts, it is necessary to lay a 0.1mm thick polyethylene innerlayer before the insulation layout. A foil is laid freely on the sealing. The pipes on the floor need to be properly fastened and secured against movement. The equalizing insulation needs to be laid to reach the floor proper structure. Another insulation layer can be put on the lower insulation. Only the "hard" insulation (EPS-DEO, PUR, ...) can be used for the equalizing insulation. The multi-layer insulation individual layers joints cannot overlap but alternate (see figure 11).

3.1. FV THERM MARGINAL INSULATION BELT ASSEMBLY

The marginal insulation belt needs to be properly done on every vertical construction part such as pillars, door openings, fireplace, elevator shaft and so forth. The marginal belt can be installed before laying the last insulation layer regarding the multi-layer construction thermal insulation. The marginal belt attached foil needs to be put so that the marginal joint between thermal and impact sound insulation is perfectly covered and the topping or water will not get into it. The marginal joints need to reach from the supporting base to the flooring surface and enable the minimal movement of 5mm regarding the heating toppings. The marginal belt has to be secured against movement when installing the topping. The insulation marginal belt situated above the topping sheet after being poured over can be removed only after top floor layer final laying to prevent the formation of an acoustic bridge or construction damage.

Also, the pointing has to be finished before removing the rest of the insulation marginal belt. Afterwards, floor socle slats are fitted.

Figure 10: FV marginal belt fitting

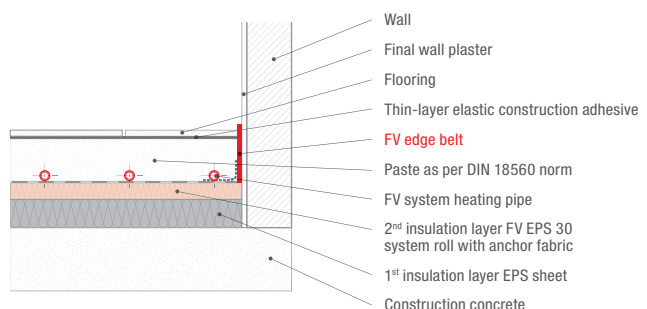

3.2. FV THERM system sheets layout

The system sheets choice depend on the thermal and impact sound insulation requirements as per ENEC / DIN 4109 / DIN 4108 norms. The insulation layers and system sheets layout is on the flat supporting base. If installation or electric lines are put on the raw floor, they need to be preserved and a space for them has to be created under the underfloor heating insulation.

The multi-layer insulation first layer needs to be adjusted so that the whole-area base and current closed area are formed for the EPS system roll / the system sheets. Regarding the two-layer layout, the layers assembly has to be done with surpassing joints. The multi-layer sandwich foil on the upper side of system rolls / sheets is the insulation layer cover layer as per DIN 18560.

A unilateral foil overlap serves as the expansion joints covering. The front expansion joints needs to be glued with a FV tape only. Filling parts inserted without the foil overlap need to be taped. It is necessary to tape properly before using the poured topping to prevent the topping or water getting into it. The dilatation joint needs to be preserved on the buildings. The floor maximal allowed assembly height has to be

Figure 11: Multi-layer insulation layout under the underfloor heating

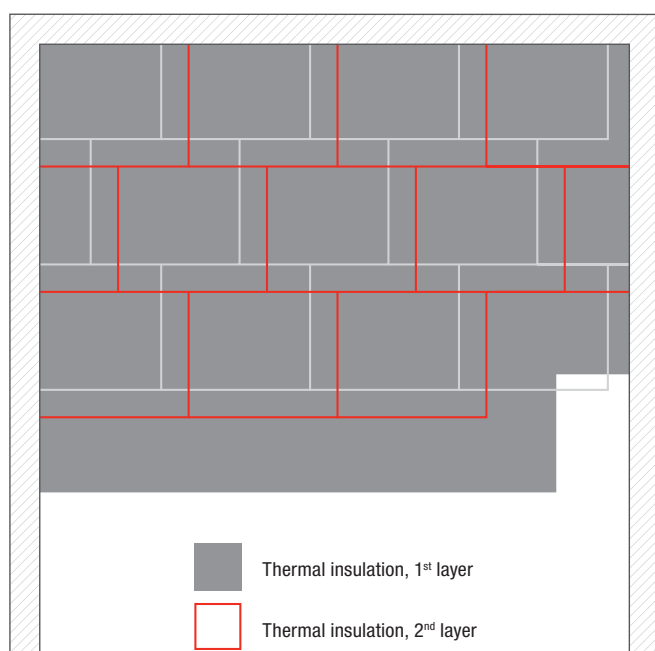

3.3. Underfloor heating distributor cabinet fitting

Floor circuit distributors are fitted into cabinets. Beside the distributor, there are closing globe valves and system inflating and air bleeding valves in the cabinet. There are also regulation components or a pump or blending. The cabinet is fitted before the circuit assembly. The FV cabinet can be placed under the plaster if the wall is thick enough; if the wall is not thick enough, the FV cabinet is fitted on the wall.

3.4. FV THERM heating pipes layout

The pipes layout starts with heating pipes fastening on the intake distributor. When tightening screws (size 30), it is important to hold a counterpart (size 24) on the distributor. Tightening moment is limited to 30N. The pipes edges have to be separated under right angle. The floor to wall crossing place is protected by putting the pipe into FV click guide piece enabling to fix the curve ranging between 0 – 90°C.

Attaching the pipes to FV EPS system roll area is done using a FV tacker clips and an original FV system stable gun. FV tacker clips are placed in the spacing of approximately 50 cm if the heating pipes are straight, the spacing of approximately 30 cm is used when changing direction. Alternatively, it is possible to put the fastening slats on the insulation and the pipes put into them.

Keeping the following spacing is needed for layout

- Vertical construction parts: 50 mm
- Elevators, shafts, chimneys, fireplaces: 200 mm

Figure 12: Counter flow piping layout

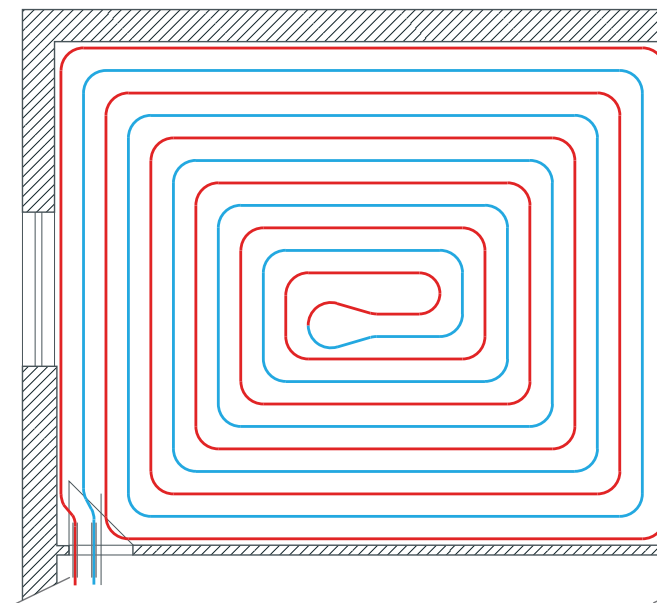
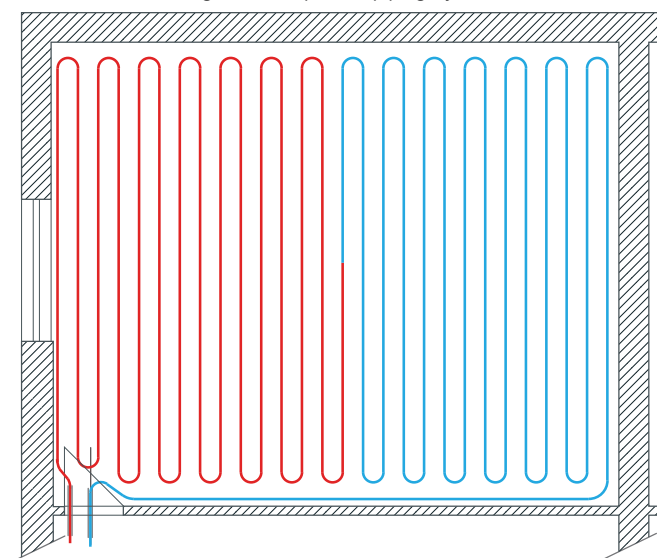

Figure 13: Serpentine piping layout



The 5 x r minimal bent ratio (pipes inner diameter) cannot be reduced as per DIN 4726 norm. The heating pipes layout can be serpentine or counter flow.

Regarding the even heat dispersion, the serpentine layout is preferred as it creates a constant course of floor temperatures. Pipes with smaller spacing than in a living part are laid in the cooler places (the northern wall with a large window or the glass wall) and the marginal zone which is either a part of the circuit or a part of the separate circuit is created.

Regarding the turning loops layout in the middle of the heating circuit, it is necessary to keep the minimal size corresponding with bent ratios as per DIN 4726. The minimal bent ratio is 75mm for 15x1.8mm pipe, 85mm for 17x2.0mm pipe. See figure 14 in case of sharp bent, $r=17 \times 5 = 85\text{mm}$, loop length 197 mm, width 170 mm valid for 17x2.0 pipe.

Figure 14:

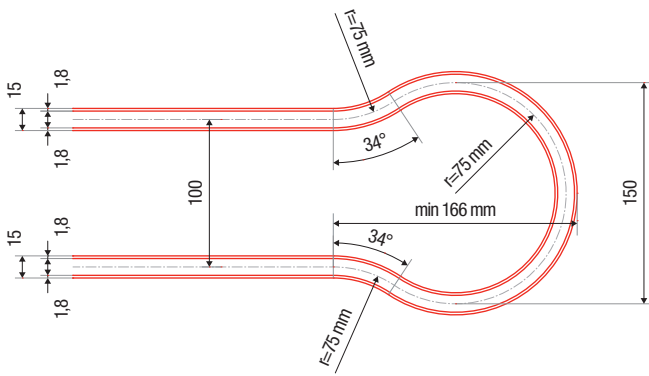

Sharp bent places formed after the violation of pipe's minimal ratio have to be removed. The clips can be assembled only on the straight lines of the pipes. The marginal pipe is put approximately 5 cm away from the marginal belt on the PE foil forming the part the marginal belt. Fastening the first pipe to the base ensures that grout will not leak under the foil.

The FV clip should be placed on the straight lines of the pipes not in the bent in case of the heating pipe repair or the processing of remaining lengths. The pipe clip has to be measured and marked in the construction documentation.

FLOOR SURFACE TEMPERATURES

Figure 15: emperature curve.Comparing "ideal heating" to FV THERM underfloor heating

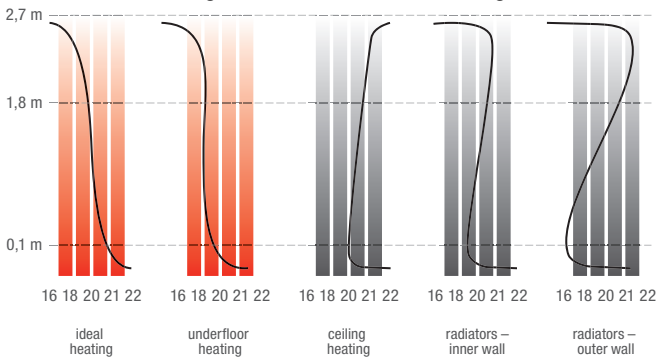

Deciding factor for the maximal surface temperature stipulation is the usage of a room. The maximal floor surface temperature is restricted to 29°C in the living area (wet rooms 33°C / the marginal zone 35°C) as per DIN EN 1264. The chosen flooring decides the surface temperature or the even distribution of the underfloor heating surface temperature.

The even distribution of temperature is decided by its heat permeability resistance, heating means excessive temperature, heating pipes layout spacing and layout type.

Living area floor surface temperatures in case of corresponding outer temperatures								
V ₂ [°C]	-15	-10	-5	±0	+5	+10	+15	+20
v ₁ [°C]~	+29,0	+27,5	+26,0	+25,0	+24,0	+23,0	+21,5	+20,0

FV THERM SYSTEM UNDERFLOOR HEATING FLOOR STRUCTURE

Figure 16: Recommended floor structure above heated rooms as per ČSN EN 1264 norm, insulation heat resistance R = 0.75m² K/W

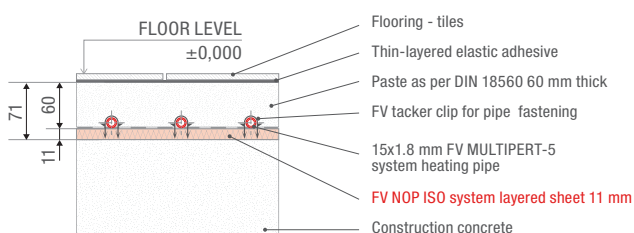

Figure 17: Recommended floor structure above cellar or occasionally heated rooms built terrain as per DIN EN 1264 norm recommendation, insulation heat resistance R = 1.25m² K/W

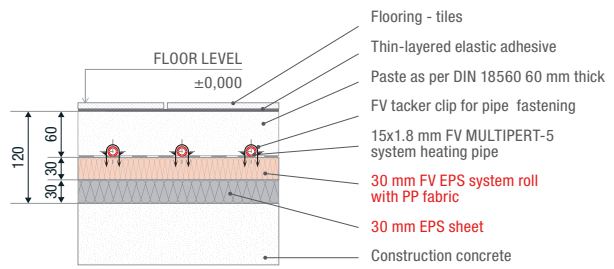
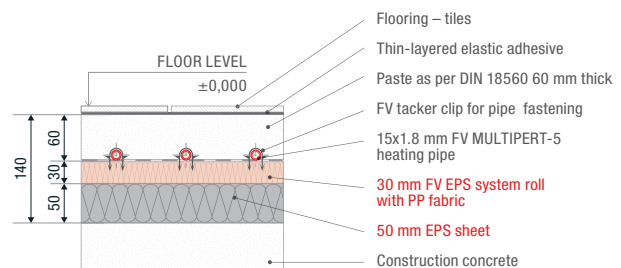

Figure 18: Recommended floor structure above outer area as per DIN EN 1264 norm recommendation, insulation heat resistance R = 2.00m² K/W



4. FV THERM FLOOR HEATING DISTRIBUTOR

Regarding the regulation technical possibilities, the separate heating circuit should be added to each room. The room is divided into several heating circuits if the room is larger than one circuit can cover. The circuits larger than 120 m are not allowed. Multiple heating circuits can form one dilatation unit.

Needed heating circuits distributor emerge from the number of installed heating circuits. Recommended maximum system pressure lost (including the distributor and connecting screws) is 250 mbar.

The distributor is designed so that it can be installed on the wall or the distributor cabinet. The maximal circuits number connected to one distributor is 12.

Figure 19: FV THERM manifold with flowmeters

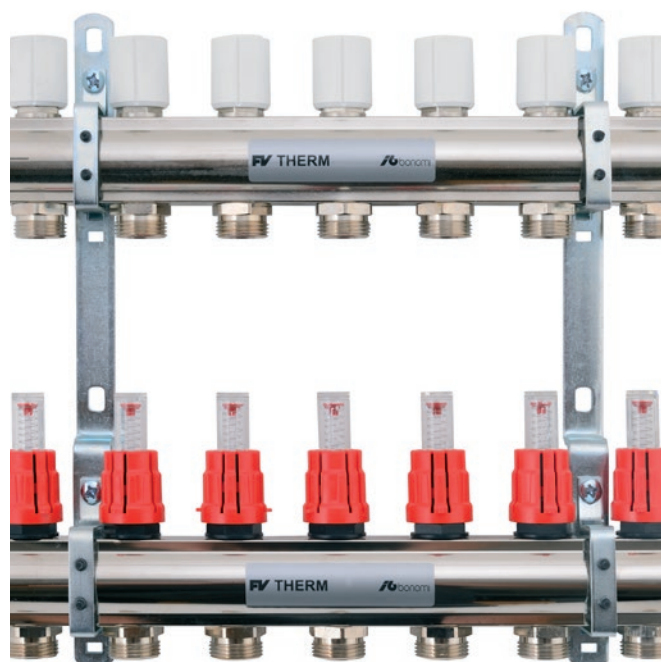

The connecting pipes from the source to the source with 1" AG connection is optional from left or right.

Figure 20: Supply and reverse connection from the side - horizontally

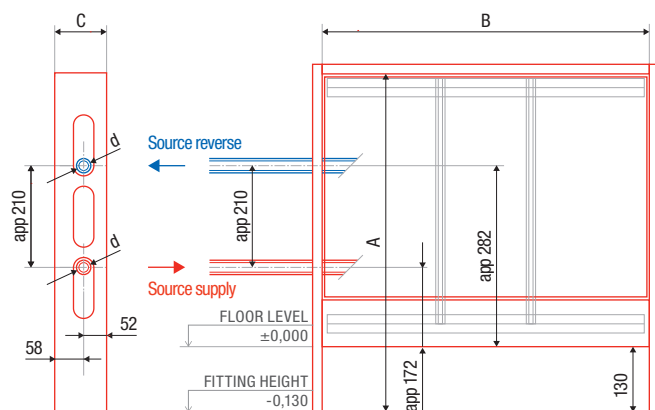

5. TIGHTNESS CONTROL

The device needs to be filled professionally and water-resistance checked after finishing installation. Norm VDI 2035 has to be met (the damage prevention in heating systems with hot water).

All intake and reverse valves are connected to the heating circuit distributor. A hose is connected to the water source. A hose ending in an outlet or outside the house is connected to a reverse arm. After the intake valve is opened, supply distributor is air bled. Afterwards, the first supply intake valve and the first reverse arm is opened.

When the heating circuit is filled with water so that no air is coming out of it, the first heating circuit is closed. The steps are analogous for other heating circuits. Filling and outlet armatures are closed when the filling and air bled process is completed. All intake and reverse valves are opened afterwards. The water-filled system undergoes a pressure testing as per ČSN EN 1264 norm requirements. The pressure testing is done by water because of the pipes damage prevention. The testing pressure is twice the amount of the operating pressure but minimal of 6 bar (as per ČSN EN 1264-4). The testing pressure is restored after two hours. Possible pressure decrease happens due to the pipes dilatation. The tes-

ting takes 12 hours. The pressure testing is successful if no water leaks from the pipes, joints and connection and the testing pressure does not decrease more than 0.1 bar per hour. A report about the pressure testing is made and inserted to the construction documentation.

The connecting system globe faucets are closed during the pressure testing to protect the heating devices and safety devices.

6. HYDRAULIC SETTING

Individual heating circuits setting is done when the tightening control is finished and before putting the device into operation (as per DIN EN 1264/EnEV). Individual heating circuits setting figures are stated in the project materials and set then on the supply arm flow indicators.

7. PASTE PRODUCTION AND PUTTING UNDERFLOOR HEATING INTO OPERATION

Pouring the underfloor heating pipes is realized after successful pressure testing is done. The pouring is done using the water-filled pipes and the operating pressure. Paste production meets DIN 1055 requirements.

Cement topping

FV plastificator is added to the cement topping for a better pipe covering, leaking concrete around the entire pipe, better heat permeability and against damages formed because of the effect of air bleeding additives containing calcium or softeners added to the topping.

The calcic sulphate and cement toppings are heated before the flooring layout. Function heating can be carried out no sooner than 21 days after using the cement toppings and 7 days using the calcic sulphate toppings.

Cement topping plastificator dosage:

$$M_s = 6,0 \cdot A_p \cdot th. [kg]$$

where: A_p = underfloor heating floor area [m²]

$th.$ = planned paste thickness [cm]

M_s = amount of FV plastificator for concrete [kg]

The theoretical usage of FV plastificator using 45mm thick sheet over the pipe:

- For 1m² of concrete topping = 0,39kg
- For 1m³ of concrete topping = 6,0kg





MANIFOLD SHAFTS

NEW BRADO

Waterproof shaft with integrated manifolds to distribute and collect anti-freeze liquid transferring heat between vertical or horizontal collectors and a heat pump. Can be connected to the piping by means of electrofusion fittings or mechanical couplers for HDPE.

- Inlet piping d50-d63, outlet piping d32 and d40
- Number of output circuits 2 to 12
- Option to attach rotameters
- Step-on PP/GF cover as standard

* xx substitute in Cat. No. with the diameter of transition pipe and yy with diameter of collector pipes



type	number of circuits	# with rotameters	# w/o rotameters	Ø of collector pipes	Ø outlet piping	vnější Ø šachty [mm]	výška šachty [mm]	vnitřní Ø šachty [mm]	weight [kg]
NEW BRADO 2	2	AA72102xxyy	AA72202xxyy	25 - 32 - 40	40 - 50 - 63 - 75 - 90	738	803	650	21
NEW BRADO 3	3	AA72103xxyy	AA72203xxyy	25 - 32 - 40	40 - 50 - 63 - 75 - 90				23
NEW BRADO 4	4	AA72104xxyy	AA72204xxyy	25 - 32 - 40	40 - 50 - 63 - 75 - 90				25
NEW BRADO 5	5	AA72105xxyy	AA72205xxyy	25 - 32 - 40	40 - 50 - 63 - 75 - 90				27
NEW BRADO 6	6	AA72106xxyy	AA72206xxyy	25 - 32 - 40	40 - 50 - 63 - 75 - 90				29
NEW BRADO 7	7	AA72107xxyy	AA72207xxyy	25 - 32 - 40	40 - 50 - 63 - 75 - 90				31
NEW BRADO 8	8	AA72108xxyy	AA72208xxyy	25 - 32 - 40	40 - 50 - 63 - 75 - 90				33
NEW BRADO 9	9	AA72109xxyy	AA72209xxyy	25 - 32 - 40	40 - 50 - 63 - 75 - 90				35
NEW BRADO 10	10	AA72110xxyy	AA72210xxyy	25 - 32 - 40	40 - 50 - 63 - 75 - 90				37
NEW BRADO 11	11	AA72111xxyy	AA72211xxyy	25 - 32 - 40	40 - 50 - 63 - 75 - 90				39
NEW BRADO 12	12	AA72112xxyy	AA72212xxyy	25 - 32 - 40	40 - 50 - 63 - 75 - 90				41

ALTRA

Waterproof shaft with integrated manifolds to distribute and collect anti-freeze liquid transferring heat between vertical or horizontal collectors and a heat pump. Can be connected to the piping by means of electrofusion fittings or mechanical couplers for HDPE.

- Inlet piping d50-d63, outlet piping d32 and d40
- Suitable for larger flat collectors
- Number of output circuits 2 to 16
- Option to attach rotameters

* xx substitute in Cat. No. with the diameter of transition pipe and yy with diameter of collector pipes



type	number of circuits	# with rotameters	# w/o rotameters	Ø of collector pipes	Ø outlet piping	height [mm]	length [mm]	width [mm]	weight [kg]
Altra 2	2	AA72302xxyy	AA72402xxyy	25 - 32 - 40	40 - 50 - 63	1230	1280	909	80
Altra 3	3	AA72303xxyy	AA72403xxyy	25 - 32 - 40	40 - 50 - 63				83
Altra 4	4	AA72304xxyy	AA72404xxyy	25 - 32 - 40	40 - 50 - 63				85
Altra 5	5	AA72305xxyy	AA72405xxyy	25 - 32 - 40	40 - 50 - 63				88
Altra 6	6	AA72306xxyy	AA72406xxyy	25 - 32 - 40	40 - 50 - 63				91
Altra 7	7	AA72307xxyy	AA72407xxyy	25 - 32 - 40	40 - 50 - 63				94
Altra 8	8	AA72308xxyy	AA72408xxyy	25 - 32 - 40	40 - 50 - 63				97
Altra 9	9	AA72309xxyy	AA72409xxyy	25 - 32 - 40	40 - 50 - 63				100
Altra 10	10	AA72310xxyy	AA72410xxyy	25 - 32 - 40	40 - 50 - 63				103
Altra 11	11	AA72311xxyy	AA72411xxyy	25 - 32 - 40	40 - 50 - 63				105
Altra 12	12	AA72312xxyy	AA72412xxyy	25 - 32 - 40	40 - 50 - 63				108
Altra 13	13	AA72313xxyy	AA72413xxyy	25 - 32 - 40	40 - 50 - 63				111
Altra 14	14	AA72314xxyy	AA72414xxyy	25 - 32 - 40	40 - 50 - 63				114

SPIDER

Waterproof shaft with integrated manifolds to distribute and collect anti-freeze liquid transferring heat between vertical or horizontal collectors and a heat pump. Can be connected to the piping by means of electrofusion fittings or mechanical couplers for HDPE.

- Inlet piping d63-d125, outlet piping d32 and d40
- Step-on PP/GF cover as standard
- Number of output circuits 15 to 25
- Option to attach rotameters

* xx substitute in Cat. No. with the diameter of transition pipe and yy with diameter of collector pipes



type	number of circuits	# with rotameters	# w/o rotameters	Ø of collector pipes	Ø outlet piping	Ø outlet piping	length [mm]	weight [kg]
SPIDER 15	15	AA72715xxyy	AA72815xxyy	32 - 40	63 - 90 - 110 - 125	1000	1640	170
SPIDER 16	16	AA72716xxyy	AA72816xxyy	32 - 40	63 - 90 - 110 - 125			172
SPIDER 17	17	AA72717xxyy	AA72817xxyy	32 - 40	63 - 90 - 110 - 125			173
SPIDER 18	18	AA72718xxyy	AA72818xxyy	32 - 40	63 - 90 - 110 - 125			175
SPIDER 19	19	AA72719xxyy	AA72819xxyy	32 - 40	63 - 90 - 110 - 125			177
SPIDER 20	20	AA72720xxyy	AA72820xxyy	32 - 40	63 - 90 - 110 - 125			180
SPIDER 21	21	AA72721xxyy	AA72821xxyy	32 - 40	63 - 90 - 110 - 125			182
SPIDER 22	22	AA72722xxyy	AA72822xxyy	32 - 40	63 - 90 - 110 - 125			184
SPIDER 23	23	AA72723xxyy	AA72823xxyy	32 - 40	63 - 90 - 110 - 125			186
SPIDER 24	24	AA72724xxyy	AA72824xxyy	32 - 40	63 - 90 - 110 - 125			188
SPIDER 25	25	AA72725xxyy	AA72825xxyy	32 - 40	63 - 90 - 110 - 125			190

SPIDER MAXI

Waterproof shaft with integrated manifolds to distribute and collect anti-freeze liquid transferring heat between vertical or horizontal collectors and a heat pump. Can be connected to the piping by means of electrofusion fittings or mechanical couplers for HDPE.

- Inlet piping d63-d125, outlet piping d32 and d40
- Step-on PP/GF cover as standard
- Number of output circuits 20 to 30
- Option to attach rotameters

* xx substitute in Cat. No. with the diameter of transition pipe and yy with diameter of collector pipes



type	number of circuits	# with rotameters	# w/o rotameters	Ø of collector pipes	Ø outlet piping	Ø outlet piping	length [mm]	weight [kg]
SPIDER MAXI 20	20	AA72920xxyy	AA73020xxyy	32 - 40	63 - 90 - 110 - 125	1200	2140	240
SPIDER MAXI 21	21	AA72921xxyy	AA73021xxyy	32 - 40	63 - 90 - 110 - 125			242
SPIDER MAXI 22	22	AA72922xxyy	AA73022xxyy	32 - 40	63 - 90 - 110 - 125			243
SPIDER MAXI 23	23	AA72923xxyy	AA73023xxyy	32 - 40	63 - 90 - 110 - 125			245
SPIDER MAXI 24	24	AA72924xxyy	AA73024xxyy	32 - 40	63 - 90 - 110 - 125			247
SPIDER MAXI 25	25	AA72925xxyy	AA73025xxyy	32 - 40	63 - 90 - 110 - 125			250
SPIDER MAXI 26	26	AA72926xxyy	AA73026xxyy	32 - 40	63 - 90 - 110 - 125			252
SPIDER MAXI 27	27	AA72927xxyy	AA73027xxyy	32 - 40	63 - 90 - 110 - 125			254
SPIDER MAXI 28	28	AA72928xxyy	AA73028xxyy	32 - 40	63 - 90 - 110 - 125			256
SPIDER MAXI 29	29	AA72929xxyy	AA73029xxyy	32 - 40	63 - 90 - 110 - 125			258
SPIDER MAXI 30	30	AA72930xxyy	AA73030xxyy	32 - 40	63 - 90 - 110 - 125			260

GIGA

Waterproof shaft with integrated manifolds to distribute and collect anti-freeze liquid transferring heat between vertical or horizontal collectors and a heat pump. Can be connected to the piping by means of electrofusion fittings or mechanical couplers for HDPE.

- Inlet piping d40-d90, outlet piping d32 and d40
- Step-on PP/GF cover as standard
- Number of output circuits 2 to 16
- Option to attach rotameters

* xx substitute in Cat. No. with the diameter of transition pipe and yy with diameter of collector pipes



type	number of circuits	# with rotameters	# w/o rotameters	Ø of collector pipes	Ø outlet piping	height [mm]	length [mm]	width [mm]	weight [kg]
Giga 2	2	AA72502xxyy	AA72602xxyy	32 - 40	40 - 50 - 63 - 90	1530	1280	909	80
Giga 3	3	AA72503xxyy	AA72603xxyy	32 - 40	40 - 50 - 63 - 90				83
Giga 4	4	AA72504xxyy	AA72604xxyy	32 - 40	40 - 50 - 63 - 90				85
Giga 5	5	AA72505xxyy	AA72605xxyy	32 - 40	40 - 50 - 63 - 90				88
Giga 6	6	AA72506xxyy	AA72606xxyy	32 - 40	40 - 50 - 63 - 90				91
Giga 7	7	AA72507xxyy	AA72607xxyy	32 - 40	40 - 50 - 63 - 90				94
Giga 8	8	AA72508xxyy	AA72608xxyy	32 - 40	40 - 50 - 63 - 90				97
Giga 9	9	AA72509xxyy	AA72609xxyy	32 - 40	40 - 50 - 63 - 90				100
Giga 10	10	AA72510xxyy	AA72610xxyy	32 - 40	40 - 50 - 63 - 90				103
Giga 11	11	AA72511xxyy	AA72611xxyy	32 - 40	40 - 50 - 63 - 90				105
Giga 12	12	AA72512xxyy	AA72612xxyy	32 - 40	40 - 50 - 63 - 90				108
Giga 13	13	AA72513xxyy	AA72613xxyy	32 - 40	40 - 50 - 63 - 90				111
Giga 14	14	AA72514xxyy	AA72614xxyy	32 - 40	40 - 50 - 63 - 90				114
Giga 15	15	AA72515xxyy	AA72615xxyy	32 - 40	40 - 50 - 63 - 90				117
Giga 16	16	AA72516xxyy	AA72616xxyy	32 - 40	40 - 50 - 63 - 90				120

MANIFOLD BOXES

NOMO

Fully equipped wall case with manifolds to distribute and collect anti-freeze liquid transferring heat between vertical or horizontal collectors and a heat pump. Can be connected to the piping by means of electrofusion fittings or mechanical couplers for HDPE.

- Inlet piping d50, outlet piping d32 and d40
- Number of output circuits 2 - 6
- Option to attach rotameters
- Placement outside a building



* xx substitute in Cat. No. with the diameter of transition pipe and yy with diameter of collector pipes

type	number of circuits	# with rotameters	# w/o rotameters	Ø of collector pipes	Ø outlet piping	height [mm]	length [mm]	width [mm]	weight [kg]
NOMO 2	2	AA73102xxyy	AA73202xxyy	25 - 32 - 40	40 - 50 - 63	790	800	320	23
NOMO 3	3	AA73103xxyy	AA73203xxyy	25 - 32 - 40	40 - 50 - 63				25
NOMO 4	4	AA73104xxyy	AA73204xxyy	25 - 32 - 40	40 - 50 - 63				26
NOMO 5	5	AA73105xxyy	AA73205xxyy	25 - 32 - 40	40 - 50 - 63				27
NOMO 6	6	AA73106xxyy	AA73206xxyy	25 - 32 - 40	40 - 50 - 63				28

REGA

Fully equipped wall case with manifolds to distribute and collect anti-freeze liquid transferring heat between vertical or horizontal collectors and a heat pump. Can be connected to the piping by means of electrofusion fittings or mechanical couplers for HDPE.

- Inlet piping d50, outlet piping d32 and d40
- Number of output circuits 2 and 3
- Option to attach rotameters
- Quality polyurethane thermal insulation
- Placement inside a building



* xx substitute in Cat. No. with the diameter of transition pipe and yy with diameter of collector pipes

type	number of circuits	# with rotameters	# w/o rotameters	Ø of collector pipes	Ø outlet piping	height [mm]	length [mm]	width [mm]	weight [kg]
REGA 2	2	AA73302xxyy	AA73402xxyy	25 - 32 - 40	40 - 50 - 63	430	380	180	7
REGA 3	3	AA73303xxyy	AA73403xxyy	25 - 32 - 40	40 - 50 - 63				8

MANIFOLD PLEIN

REGO

Fully equipped wall manifolds to distribute and collect anti-freeze liquid transferring heat between vertical or horizontal collectors and a heat pump. Can be connected to the piping by means of electrofusion fittings or mechanical couplers for HDPE.

- Inlet piping d50, outlet piping d32 and d40
- Number of output circuits 2 - 12
- Option to attach rotameters
- Quality polyurethane thermal insulation
- Placement inside a building



* xx substitute in Cat. No. with the diameter of transition pipe and yy with diameter of collector pipes

type	number of circuits	# with rotameters	# w/o rotameters	Ø of collector pipes	Ø outlet piping	height [mm]	length [mm]	width [mm]	weight [kg]
REGO 2	2	AA73502xxyy	AA73602xxyy	25 - 32 - 40	40 - 50 - 63	430	480	265	13
REGO 3	3	AA73503xxyy	AA73603xxyy	25 - 32 - 40	40 - 50 - 63				14
REGO 4	4	AA73504xxyy	AA73604xxyy	25 - 32 - 40	40 - 50 - 63				15
REGO 5	5	AA73505xxyy	AA73605xxyy	25 - 32 - 40	40 - 50 - 63				16
REGO 6	6	AA73506xxyy	AA73606xxyy	25 - 32 - 40	40 - 50 - 63				17
REGO 7	7	AA73507xxyy	AA73607xxyy	25 - 32 - 40	40 - 50 - 63				18
REGO 8	8	AA73508xxyy	AA73608xxyy	25 - 32 - 40	40 - 50 - 63				19
REGO 9	9	AA73509xxyy	AA73609xxyy	25 - 32 - 40	40 - 50 - 63				20
REGO 10	10	AA73510xxyy	AA73610xxyy	25 - 32 - 40	40 - 50 - 63				21
REGO 11	11	AA73511xxyy	AA73611xxyy	25 - 32 - 40	40 - 50 - 63				22
REGO 12	12	AA73512xxyy	AA73612xxyy	25 - 32 - 40	40 - 50 - 63				23

ACCESSORIES TO DISTRIBUTOR WELLS

type	unit	package	#	Ø outer [mm]	Ø inner [mm]	height [mm]
ERGA extension for shafts NEW BRADO a SPIDER	pcs	1	AA750100001			500
GEO 500 extension for shafts ALTRA a GIGA	pcs	1	AA750100002			500
BAGELAN A seal for extension GEO 500	pcs	1	AA750200001			
BAGELAN B seal for extension ERGA	pcs	1	AA750200002			
Seal for extension	pcs	1	AA750200003			
Manhole PE cover 10 kN	pcs	1	AA751100010			
Manhole PE cover 10 kN with safety lock	pcs	1	AA751100011			
Manhole PE cover 10 kN with thermal insulation 200 mm	pcs	1	AA751100012			200
Seal for manhole cover	pcs	1	AA751200000			
Load relief concrete ring symmetrical	pcs	1	AA751100402	1440	670	200
Load relief concrete ring unsymmetrical	pcs	1	AA751100403	1440	670	200
Manhole cover cast iron class D 400 kN	pcs	1	AA751100400	820	680	115
Leakproof PE cover under cast iron or concrete manhole cover	pcs	1	AA751100401	670		

FITTINGS

Electrofusion socket SDR 11

For the system FV ENERGEO we deliver reliable electrofusion fittings Georg Fisher with integrated brackets to 63mm diameter.

- They are equipped with barcode
- integrated holders



dimensions	unit	package	#	length [mm]		
25	pcs	1	AA760000025			
32	pcs	1	AA760000032			
40	pcs	1	AA760000040			
50	pcs	1	AA760000050			
63	pcs	1	AA760000063			
90	pcs	1	AA760000090			
110	pcs	1	AA760000110			

Electrofusion blinding SDR 11

For the system FV ENERGEO we deliver reliable electrofusion fittings Georg Fisher with integrated brackets to 63mm diameter.

- They are equipped with barcode
- integrated holders



dimensions	unit	package	#	length [mm]		
25	pcs	1	AA761000025			
32	pcs	1	AA761000032			
40	pcs	1	AA761000040			
50	pcs	1	AA761000050			
63	pcs	1	AA761000063			

Electrofusion reduction of SDR 11

For the system FV ENERGEO we deliver reliable electrofusion fittings Georg Fisher with integrated brackets to 63mm diameter.

- They are equipped with barcode
- integrated holders



dimensions	unit	package	#	length [mm]		
40 - 32	pcs	1	AA762040032			
32 - 25	pcs	1	AA762032025			

Electrofusion bend 90° SDR 11

For the system FV ENERGEO we deliver reliable electrofusion fittings Georg Fisher with integrated brackets to 63mm diameter.

- They are equipped with barcode
- integrated holders



dimensions	unit	package	#			
25	pcs	1	AA763000025			
32	pcs	1	AA763000032			
40	pcs	1	AA763000040			
50	pcs	1	AA763000050			
63	pcs	1	AA763000063			
90	pcs	1	AA763000090			
110	pcs	1	AA763000110			

Insert transition PE - brass female thread SDR 11

For the system FV ENERGEO we deliver reliable electrofusion fittings Georg Fisher with integrated brackets to 63mm diameter.

- They are equipped with barcode
- integrated holders



dimensions	unit	package	#			
32 - 1"	pcs	1	AA764032010			
40 - 1 1/4"	pcs	1	AA764040054			
50 - 1 1/2"	pcs	1	AA764050064			
63 - 1"	pcs	1	AA764063010			
63 - 1 1/4"	pcs	1	AA764063054			
63 - 1 1/2"	pcs	1	AA764063064			
63 - 2"	pcs	1	AA764063020			

Insert transition PE - brass male thread SDR 11

For the system FV ENERGEO we deliver reliable electrofusion fittings Georg Fisher with integrated brackets to 63mm diameter.

- They are equipped with barcode
- integrated holders



dimensions	unit	package	#			
25 - 3/4"	pcs	1	AA765025034			
32 - 1"	pcs	1	AA765032010			
32 - 1 1/4"	pcs	1	AA765032054			
32 - 1 1/2"	pcs	1	AA765032064			
40 - 1"	pcs	1	AA765040010			
40 - 1 1/4"	pcs	1	AA765040054			
40 - 1 1/2"	pcs	1	AA765040064			
50 - 1"	pcs	1	AA765050010			
50 - 1 1/4"	pcs	1	AA765050054			
50 - 1 1/2"	pcs	1	AA765050064			
63 - 1 1/4"	pcs	1	AA765063054			
63 - 1 1/2"	pcs	1	AA765063064			
63 - 2"	pcs	1	AA765063020			

Insert transition PE - brass with nut SDR 11

For the system FV ENERGEO we deliver reliable electrofusion fittings Georg Fisher with integrated brackets to 63mm diameter.

- They are equipped with barcode
- integrated holders



dimensions	unit	package	#			
25 - 3/4"	pcs	1	AA766025034			
32 - 1"	pcs	1	AA766032010			
40 - 1 1/4"	pcs	1	AA766040054			
50 - 1 1/2"	pcs	1	AA766050064			
63 - 1"	pcs	1	AA766063010			
63 - 1 1/2"	pcs	1	AA766063064			
63 - 2"	pcs	1	AA766063020			

Electrofusion Y-piece - reducing the number of branches

For the system FV ENERGEO we deliver reliable electrofusion fittings Georg Fisher with integrated brackets to 63mm diameter.

- They are equipped with barcode
- integrated holders



dimensions	unit	package	#	d1 [mm]	d2 [mm]	length [mm]
32/32 - 40 direct	pcs	1	AA767003240	32	40	236
40/40 - 50 direct	pcs	1	AA767004050	40	50	255
32/32 - 40 90°	pcs	1	AA767103240	32	40	245
40/40 - 50 90°	pcs	1	AA767104050	40	50	270

PROBES

FV ENERGEO GH 12,5

Single-circuit vertical collectors designed to draw heat from geothermal boreholes to supply all types of soil/water heat pumps.

- d40x3,7 and d32x3,0mm, l 50 - 150m
- Robust head with fine factorywelding seam
- Full diameter in the whole profile of the collector
- Strong resistance to crack propagation
- More than 100 years of life



type	unit	weight [kg]	Ø of coil	height of coil	#	D [mm]	length [mm]
2 × 32 × 60	pcs	28	1.148	256	AA700123060	32	60
2 × 32 × 70	pcs	32	1.212	256	AA700123070	32	70
2 × 32 × 80	pcs	37	1.148	320	AA700123080	32	80
2 × 32 × 90	pcs	41	1.148	320	AA700123090	32	90
2 × 32 × 100	pcs	46	1.212	320	AA700123100	32	100
2 × 32 × 110	pcs	51	1.212	384	AA700123110	32	110
2 × 32 × 120	pcs	55	1.212	384	AA700123120	32	120
2 × 32 × 130	pcs	60	1.276	384	AA700123130	32	130
2 × 32 × 140	pcs	64	1.276	384	AA700123140	32	140
2 × 32 × 150	pcs	69	1.340	384	AA700123150	32	150
2 × 40 × 60	pcs	42	1.180	320	AA700124060	40	60
2 × 40 × 70	pcs	49	1.180	400	AA700124070	40	70
2 × 40 × 80	pcs	56	1.180	400	AA700124080	40	80
2 × 40 × 90	pcs	63	1.260	400	AA700124090	40	90
2 × 40 × 100	pcs	70	1.340	400	AA700124100	40	100
2 × 40 × 110	pcs	77	1.340	400	AA700124110	40	110
2 × 40 × 120	pcs	84	1.420	400	AA700124120	40	120
2 × 40 × 130	pcs	91	1.500	400	AA700124130	40	130
2 × 40 × 140	pcs	98	1.500	400	AA700124140	40	140
2 × 40 × 150	pcs	105	1.500	480	AA700124150	40	150

FV ENERGEO GH 16

Single-circuit vertical collectors designed to draw heat from geothermal boreholes to supply all types of soil/water heat pumps.

- d 40x3,7 and d 32x3,0mm, l 130 - 220m
- Robust head with fine factorywelding seam
- Full diameter in the whole profile of the collector
- Strong resistance to crack propagation
- More than 100 years of life



type	unit	weight [kg]	Ø of coil	height of coil	#	D [mm]	length [mm]
2 × 32 × 130	pcs	73	1276	384	AA700163130	32	130
2 × 32 × 140	pcs	78	1276	384	AA700163140	32	140
2 × 32 × 150	pcs	84	1340	384	AA700163150	32	150
2 × 32 × 160	pcs	90	1404	384	AA700163160	32	160
2 × 40 × 130	pcs	109	1500	400	AA700164130	40	130
2 × 40 × 140	pcs	118	1500	400	AA700164140	40	140
2 × 40 × 150	pcs	126	1500	480	AA700164150	40	150
2 × 40 × 160	pcs	134	1500	480	AA700164160	40	160
2 × 40 × 170	pcs	143	1580	480	AA700164170	40	170
2 × 40 × 180	pcs	151	1580	480	AA700164180	40	180
2 × 40 × 190	pcs	160	1660	480	AA700164190	40	190
2 × 40 × 200	pcs	168	1660	480	AA700164200	40	200
2 × 40 × 210	pcs	176	1580	560	AA700164210	40	210
2 × 40 × 220	pcs	185	1660	560	AA700164220	40	220

FV ENERGEO GH DUO 12

Double-circuit vertical collectors designed to draw heat from geothermal boreholes to supply all types of soil/water heat pumps.

- d 32x3,0mm, l 60 - 130m
- Robust head with fine factorywelding seam
- Full diameter in the whole profile of the collector
- Strong resistance to crack propagation
- More than 100 years of life



type	unit	weight [kg]	Ø of coil	height of coil	#	D [mm]	length [mm]
4 × 32 × 60	pcs	55	1212	384	AA701123060	32	60
4 × 32 × 70	pcs	64	1276	384	AA701123070	32	70
4 × 32 × 80	pcs	74	1212	512	AA701123080	32	80
4 × 32 × 90	pcs	83	1276	512	AA701123090	32	90
4 × 32 × 100	pcs	92	1212	640	AA701123100	32	100
4 × 32 × 110	pcs	101	1276	640	AA701123110	32	110
4 × 32 × 120	pcs	110	1340	640	AA701123120	32	120
4 × 32 × 130	pcs	120	1340	640	AA701123130	32	130

FV ENERGEO GH DUO 16

Double-circuit vertical collectors designed to draw heat from geothermal boreholes to supply all types of soil/water heat pumps.

- d 32x3,0mm, l 120 - 150m
- Robust head with fine factorywelding seam
- Full diameter in the whole profile of the collector
- Strong resistance to crack propagation
- More than 100 years of life



typ	unit	weight [kg]	Ø of coil	height of coil	#	D [mm]	length [mm]
4 × 32 × 120	pcs	134	1340	640	AA701163120	32	120
4 × 32 × 130	pcs	146	1340	640	AA701163130	32	130
4 × 32 × 140	pcs	157	1276	768	AA701163140	32	140
4 × 32 × 150	pcs	168	1340	768	AA701163150	32	150

PIPES FOR HORIZONTAL COLLECTOR

FV ENERGEO CP HDPE 100RC PN 10

High-quality HDPE RC pipes for construction of horizontal collectors of heat pumps ground/water. They are produced of the latest technology under permanent control of the top HDPE 100-RC polymer which ensures long-lasting perfect functionality of the system.

- High reliability and safety with life of over 100 years
- Low installation costs
- Increased resistance during handling
- Allows more difficult conditions when laying pipes
- Long-term pressure resistance even in case of mechanical damage



dimensions	unit	weight [kg]	Ø of coil [mm]	height of coil	#	D [mm]	length [m]
32 × 2,0 × 100	pcs	19	1150	192	AA710103100	32	100
32 × 2,0 × 150	pcs	29	1150	288	AA710103150	32	150
32 × 2,0 × 200	pcs	38	1150	384	AA710103200	32	200
40 × 2,4 × 100	pcs	28	1180	280	AA710104100	40	100
40 × 2,4 × 150	pcs	42	1180	440	AA710104150	40	150
40 × 2,4 × 200	pcs	56	1260	480	AA710104200	40	200

FV ENERGEO CP HDPE 100RC PN 12,5

High-quality HDPE RC pipes for construction of horizontal collectors of heat pumps ground/water. They are produced of the latest technology under permanent control of the top HDPE 100-RC polymer which ensures long-lasting perfect functionality of the system.

- High reliability and safety with life of over 100 years
- Low installation costs
- Increased resistance during handling
- Allows more difficult conditions when laying pipes
- Long-term pressure resistance even in case of mechanical damage



dimensions	unit	weight [kg]	Ø of coil [mm]	height of coil	#	D [mm]	length [m]
32 × 2,4 × 100	pcs	23	1150	192	AA710123100	32	100
32 × 2,4 × 150	pcs	35	1150	288	AA710123150	32	150
32 × 2,4 × 200	pcs	46	1150	384	AA710123200	32	200
40 × 3,0 × 100	pcs	35	1180	280	AA710124100	40	100
40 × 3,0 × 150	pcs	53	1180	440	AA710124150	40	150
40 × 3,0 × 200	pcs	70	1260	480	AA710124200	40	200

FV ENERGEO CP HDPE 100RC PN 16

High-quality HDPE RC pipes for construction of horizontal collectors of heat pumps ground/water. They are produced of the latest technology under permanent control of the top HDPE 100-RC polymer which ensures long-lasting perfect functionality of the system.

- High reliability and safety with life of over 100 years
- Low installation costs
- Increased resistance during handling
- Allows more difficult conditions when laying pipes
- Long-term pressure resistance even in case of mechanical damage



dimensions	unit	weight [kg]	Ø of coil [mm]	height of coil	#	D [mm]	length [m]
32 × 3,0 × 100	pcs	28	1150	192	AA710163100	32	100
32 × 3,0 × 150	pcs	42	1150	288	AA710163150	32	150
32 × 3,0 × 200	pcs	56	1150	384	AA710163200	32	200
40 × 3,7 × 100	pcs	42	1180	280	AA710164100	40	100
40 × 3,7 × 150	pcs	63	1180	440	AA710164150	40	150
40 × 3,7 × 200	pcs	84	1260	480	AA710164200	40	200

TOOLS

Electrofusion welder with barcode reader



	☺	☐	📏	#
SVEL 3500 - 3800W for d20-d300mm	pcs	1	26,0	AA401102000
SVEL 3500 PLUS 3800W for d20-d300mm with integrated list and direct printing welding Protocol	pcs	1	26,0	AA401104000

Weight



	☺	☐	📏	#
FV GS 32 13	pcs	1	13	AA709032013
FV GS 32 26	pcs	1	26	AA709032026
FV GS 40 13	pcs	1	13	AA709040013
FV GS 40 26	pcs	1	26	AA709040026

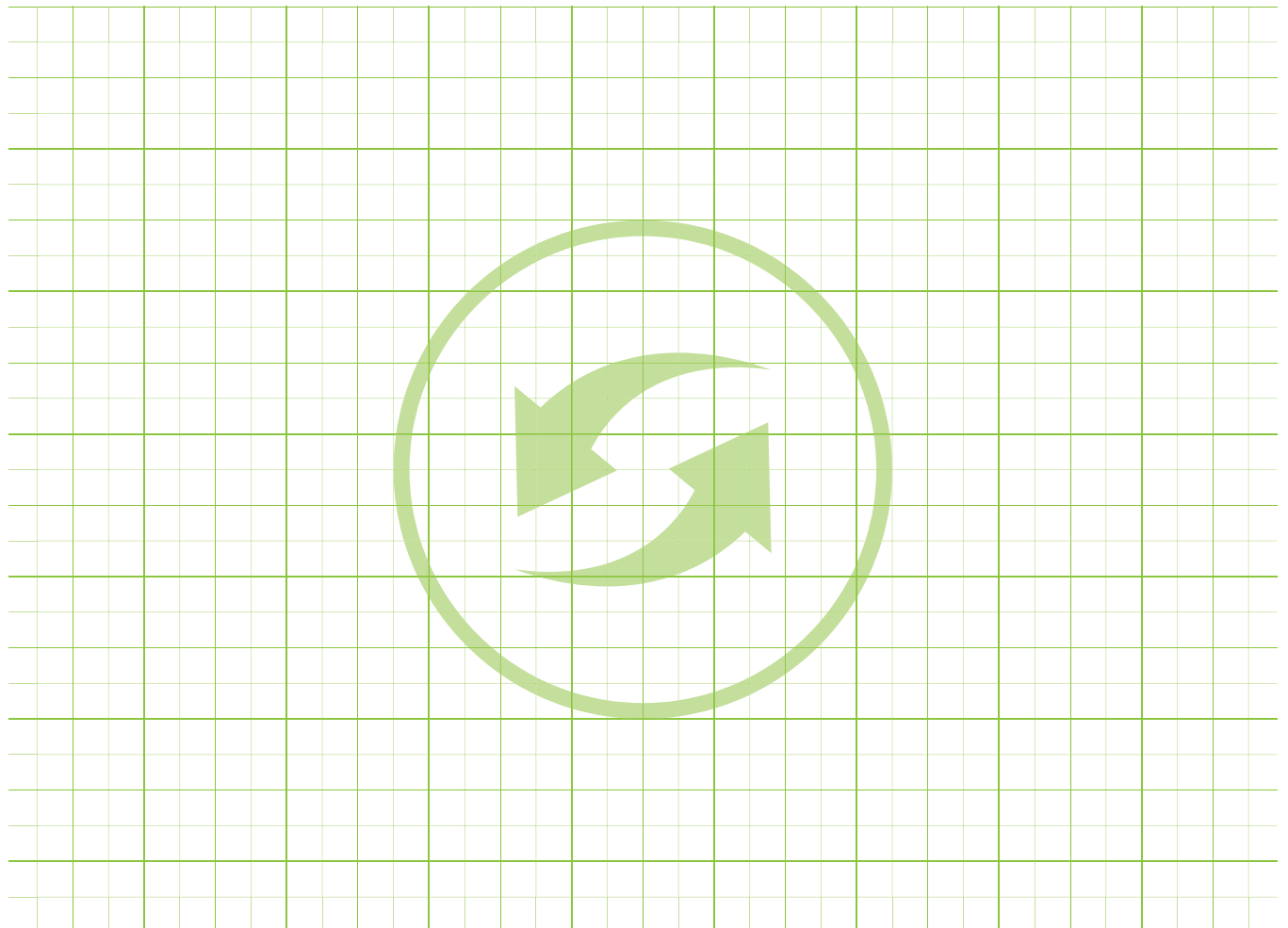

INSTRUCTIONS FOR LAYING GROUND PROBES AND COLLECTORS

FV ENERGEO is a complete system of key elements for utilization of geothermal energy by means of depth wells and surface ground collectors. Geothermal energy is one of the most environmental-friendly and virtually inexhaustible heat resources and thus represents an attractive solution with an interesting returnability.

The installation design of the geothermal systems with heat pumps can be carried out exclusively by authorized persons and firms. Drilling of depth wells is addressed by specific legal codes for mining and in most countries it falls under the jurisdiction of the mining office.

SURFACE COLLECTORS

A system of ground surface collectors is the most effective option when considering the choice of the type of installation of a heat pump. Acquisition costs are comparable to the air-water system, the advantage being a higher effectivity (COP) and longer lifespan of the compressor.

In the case of surface collectors, the energy is obtained by means of piping laid horizontally below the ground, usually in a 1.2-1.5m deep excavation, or alternatively in a groove dug by a trencher. For collectors, a piping of d32 to d40 is typically used, rarely also d25.

In the piping system circulates an antifreeze liquid (alcohol, glycerine, glycol) which is diluted with water to the required ZÁMRZNOST. In the heat pump it passes its heat to the cooling agent, which then gains it back by its heating under the ground. The temperature of the ground in the depths up to 5m is influenced by outside conditions (rain, snow, wind) and it also differs according to the season.

After the collectors are placed, it is not possible to carry out any other construction in this location. According to the bedrock, surface collectors must be constructed with a piping FV ENERGEO HDPE 100R C in pressure lines PN10, PN12.5 and PN16. This material enables laying without sand bed and carrying out of backfill using directly the dug material including aggregate up to the size of 200mm.

Bedrock	Specific consumption	
	at 1800 h	at 2400h
Dry soil	10W/m ²	8W/m ²
Cohesive soil, wet	20-30W/m ²	16-24W/m ²
Watery sand / grit	40W/m ²	32W/m ²

CONNECTING

For connecting of individual pipes, mainly electro pipe fittings are used, rarely mechanical clamp links. When using the electro pipe fittings, a completely homogeneous link arises, therefore in the system FV ENERGEO we use high-quality electro pipe fittings Georg Fisher.

The work must be carried out by workers with welding license for plastic welding.

It is not possible to weld polyethylene with polypropylene, but at the same time we warn about mutual welding of pipes and pipe fittings from branched (LDPE, rPE) and linear polyethylene. Welding of these relatively hardly distinguishable materials (LDPE has thicker walls for the same pressure) cannot be by any means carried out in practice.

If it is necessary to connect these two materials, in case of any doubt about the origin of particular pipes, you are better advised to use mechanical clamp links.

BACKBONE PIPEAGE

Connection of a distributor / collector with thermal pumps is carried out by means of backbone pipeage. Backbone pipeage is made by a polyethylene piping of a higher diameter FV ENERGEO HDPE or FV ENERGEO HDPE-RC. The diameter of the piping is determined according to its length and a flow rate of the antifreeze liquid.

It is necessary to lay the backbone pipeage of the HDPE pipes in the sand bed.

INSULATION OF A PRIMARY CIRCUIT

All kinds of pipes, be it backbone pipeage or piping leading directly to the wells in the case of the surface collector, need to be insulated, beginning at 2 m away from the object. All pipes inside the object also need to be insulated, so as to avoid potential water condensation at the distributions.

It is only possible to insulate the primary circuit with a suitable rubber insulation, not with an insulation of the PE material and the like. It is necessary to protect the piping insulated by a rubber insulation outside the object by a cable duct and provide it with a gasket preventing the water intrusion into the gasket. Principles of correct installation of ground surface collectors:

- Right proportioning – the most important protection against freezing of the collector
- Drop pipe for easy bleeding at the highest point
- Compliance with safe pitches of piping – at least 60-100cm according to the piping diameter, optimally 1m.
- Laying of collectors at least 0.7-1m away from the water pipe / sewerage, in case of crossing with engineering networks insulating of the piping.

GEO THERMAL WELLS

In the case of geothermal wells the energy is obtained by means of geothermal ground probes. It is a closed system, where wells in the depth between 70m and 300m are machined by the piping FV ENERGEO HDPE-RC. At the end of the piping, there is a returnable U bend. Two basic ways of machining are used:

- One-circuit probes with pipes 2x25, 2x32 or 2x40mm
- Two-circuit probes with pipes 4x32mm.

The most common well depth is 150m. The temperature at the depth of 20m under ground is approximately 10°C and rises by 1°C for every 30m – it is not influenced by momentary weather conditions or outside temperature at the surface, nevertheless it differs at the beginning and at the end of the season. At the depth of 150m, there is virtually stable temperature of 15°C, which is sufficient for the needful thermal gain. The higher thermal gain at greater depths is compensated by the significant growth of installation costs (well and machining). There is an antifreeze mixture (alcohol, glycerine, glycol), which is diluted with water to the required zámraznost.

When proportioning the depth of the wells, we recommend expecting the profitability up to 50W/m for heating and up to the load of about 2400 hours yearly including the TUV heating. The profitability should be verified appropriately by a special test.

Bedrock	Specific consumption	
	at 1800h	at 2400h
Bad bedrock (dry sediment) - (λ . Normal solid rock and watery sediment- ($\lambda=1,5-3,0$ W/(m•K))	60W/m	50 W/m
Solid rock with high thermal conductivity - ($\lambda>m\bullet3,0$ W/(m•K))	84W/m	70W/m
Individual rocks		
Dry sand, grit carrying water	65-80W/m	55-65W/m
In the case of a strong underground water-course in sand or grit, individual	80-100W/m	80-100W/m
Clay, soil, wet	35-50W/m	30-40W/m
Limestone massif	55-70W/m	45-60W/m
Sandstone	65-80W/m	55-65W/m
Acid magmatic rock (e.g. granite)	65-85W/m	55-70W/m
Basic magmatic rock (e.g. basalt)	40-65W/m	35-55W/m
Gneiss	70-85W/m	60-70W/m

Values may vary depending on the texture of rock (jointing, shale, weathering).

REDUCTION IN THE NUMBER OF BRANCHES (Y-PIECE)

Y-piece is a special pipe fitting for associating of two circuit geothermal ground probes in one circuit (32-32-40, or 40-40-50). By their use the number of connecting pipings leading from the well to the system of the distributor / collector and also the number of the outputs of the distributor / collector itself is reduced. Y-piece CANNOT be replaced by a classical T-piece because of the prevention of a strong pressure loss in the whole system! When using the reduction it is necessary to abide by an even division of the flow of the liquid into both loops of the geothermal well.

Principles of correct implementation of geothermal wells:

- Correct proportioning of the depth and the number of wells (wrong proportioning can lead to a freezing of the well)
- Compliance with safe distances between the geothermal wells according to the depth of the well – 10% from the total well depth recommended
- Using of the FVENERGEOHDPE-RC probes
- Using services of verified drilling companies (a necessity of the implementation of the works with an approval of corresponding authorities)
- Compliance with basic conditions and not jeopardizing current systems of drilled / dug water wells in the vicinity (injecting of wells – isolation of particular water wells)

Before the project itself it is necessary to ascertain whether it is possible to drill at the estate, and to which depth. (in Nature Conservation Areas, areas of mining shafts, buffer zones of Prague underground)

LAYING OF A SAND BED

Laying in an open excavation, where sand is used for underlaying and surrounding of the piping, is one of the oldest ways of layings for PE piping. If we did not lay the older types of PE pipings (PE63, PE80 and PE100) which do not possess improved resistance to mechanical stress in sand, their expected lifespan would be reduced more than five times. Thanks to the sand underlaying and surrounding, which protects the piping, this method of laying is one of the laying methods with a low risk of damage.

LAYING

In the case of the piping from HDPE-RC, its laying and backfill can be carried out without the sand bed, using the directly excavated soil including the aggregate up to 200mm.

In the case of HDPE pipings it is necessary to respect the character of the bedrock. If the piping route occurs in areas with soils of the minability class I. to IV. (according to ČSN736133:2010), we can also use the directly excavated soil for the laying. An exact determination of the minability class can only be determined by a geological research, that is usually a part of each project preparation. Earthwork during the piping laying must not influence its ovality. Material for surrounding and backfill need to be compactable enough. Piping is laid onto the even and paved bottom of a groove. The surrounding is carried out layer by layer and is compacted.

If the route of the piping is located in areas with soils of the minability classes of V. to VII. or where the occurrence of these soils cannot be disproved, it is necessary to duly lay the piping in a sand bed.

CONNECTING

For connecting of individual pipings, mainly electro pipe fittings, and rarely mechanical clamp links are used. When electro pipe fittings are used, a completely homogenous link arises, therefore in the FV ENERGEO system we use high-quality electro pipe fittings Georg Fisher.

WELDING

For connecting the FV ENERGEO HDPE and HDPE-RC pipes with pipe fittings or butt welding can be used, polyfusion or with the use of electro pipe fittings which we recommend for the FV ENERGEO system. Apart from a problem-free connecting right in the field, electro pipe fittings also enable assembling of the whole piping thanks to integrated clamps.

Welding work must be carried out by workers with welding licence for plastic welding.

It is unacceptable to weld polyethylene with polypropylene and to weld pipings and pipe fittings of branched (LDPE, rPE) and linear (HDPE, HDPE-RC) polyethylene. If it is necessary to connect these two materials, mechanical clamp links must be used.

The most important operations for achieving a high-quality weld are:

- cleansing of the ends of the pipes or pipe fittings of mechanical dirt
- perpendicular trimming (planing) of the ends of the pipes, so that the maximum distance between the contacted pipes is 0.5 mm.
- check of mutual overrunning of the pipings which must not exceed 1/10 of the wall thickness (be careful about pipings from different pressure lines!)
- in the case of polyfusion and electro welding removing of an oxidizable layer of plastic with subsequent cleansing with a suitable degreasing and cleansing agent. Cleansing is carried out immediately before welding and cleansed surfaces must not be contaminated by a touch of a hand.
- A place of butt welding or polyfusion welding should be protected against weather conditions.

Be careful about welding at low temperatures – allowed minimum temperatures at which welding is still possible, are determined by the properties of welding machines or electro pipe fittings. In the strong wind, in the case of butt welding or polyfusion welding, it is necessary to check not only the right temperature settings of the welding agents, but also the actual agent temperature.

Welding temperature for PE butt welding is 200–220°C, for polyfusion welding 250–270°C. It is important to comply with the time course of particular operations including the time for weld cooling, during which the weld cannot be burdened mechanically. In this context we refer to the instructions of the manufacturers of particular welding devices and primarily to the compulsory trainings.

MECHANICAL CONNECTING

Mechanical clamp links enable connecting of combinations of different materials and also enable the use of slightly oval pipings which can be formed by pipe fittings. Links can be metal or plastic. When carried out properly, the link has the same or higher breaking strain than the connected piping itself. Connecting using flanges (edge bearers).

MANIPULATION WITH THE PIPING, MECHANICAL STRAIN AND CHANGE IN THE DIRECTION OF THE PIPING (BENDING)

It is not allowed to carry out heat shaping of the pipes at the construction site. However, PE elasticity allows for a change of direction or copying the terrain by producing arcs with a diameter R, which should be, according to the temperature (independently of the piping pressure line):

- 20°C.....20 x D
- 10°C.....35 x D
- 0°C.....50 x D

where D is the outer piping diameter. A properly carried out excavation can therefore mean savings of the material and time.

For more significant changes in the direction, particular pipe fittings need to be used.

Spools with pipings must be protected against mechanical damage. In a case of visible damage of the outer layer (its cutting or rubbing) it is necessary to cut out the particular piping and connect the ends with a suitable pipe fitting.

Pipes can only be unwinded the opposite way than they have been winded during their production. Spiral unwinding, when the wall of the piping is strained torsionally and when there is a danger of „breaking“ the piping, is strictly forbidden.

Fittings and cast iron pipe fittings need to be built in in such a way that their own mass or forces needed for their operation would not produce forces that were not taken into account when designing. We recommend fixing the fittings by a „firm point“, e.g. using a concrete block and so on.



FV INFRA PIPES

FV HDPE 100 SDR11

System: **FV INFRA**
 Material: HDPE
 Standard: ČSN EN 12201-2
 Details: Length 12m on request

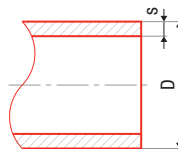

DN	⊕	⊞	⊞	⊞	⊞	#	D [mm]	s [mm]	SDR	l [m]	
25 × 2,3	m				0,17	0,73	AA160025100	25	2,3	11	100
32 × 3,0	m				0,27	1,10	AA160032100	32	3	11	100
40 × 3,7	m				0,43	1,83	AA160040100	40	3,7	11	100
50 × 4,6	m				0,67	2,75	AA160050100	50	4,6	11	100
63 × 5,8	m				1,05	4,07	AA160063100	63	5,8	11	100
25 × 2,3	m				0,17	0,73	AA160025006	25	2,3	11	6
32 × 3,0	m				0,27	1,10	AA160032006	32	3,0	11	6
40 × 3,7	m				0,43	1,83	AA160040006	40	3,7	11	6
50 × 4,6	m				0,67	2,75	AA160050006	50	4,6	11	6
63 × 5,8	m				1,05	4,07	AA160063006	63	5,8	11	6

FV HDPE 100 SDR17

System: **FV INFRA**
 Material: HDPE
 Standard: ČSN EN 12201-2
 Details: Length 12m on request

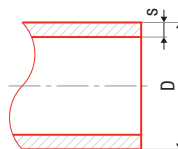

DN	⊕	⊞	⊞	⊞	⊞	#	D [mm]	s [mm]	SDR	l [m]	
32 × 2,0	m				0,19	1,10	AA161032100	32	2,0	17	100
40 × 2,4	m				0,30	1,83	AA161040100	40	2,4	17	100
50 × 3,0	m				0,45	2,75	AA161050100	50	3,0	17	100
63 × 3,8	m				0,72	4,07	AA161063100	63	3,8	17	100
32 × 2,0	m				0,19	1,10	AA161032006	32	2,0	17	6
40 × 2,4	m				0,30	1,83	AA161040006	40	2,4	17	6
50 × 3,0	m				0,45	2,75	AA161050006	50	3,0	17	6
63 × 3,8	m				0,72	4,07	AA161063006	63	3,8	17	6

FV HDPE 100 RC SDR 11

System: **FV INFRA**
 Material: HDPE
 Standard: ČSN EN 12201-2
 Details: Length 12m on request

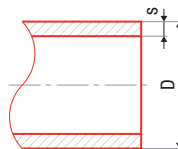

DN	⊕	⊞	⊞	⊞	⊞	#	D [mm]	s [mm]	SDR	l [m]	
25 × 2,3	m				0,17	0,73	AA162025100	25	2,3	11	100
32 × 3,0	m				0,27	1,10	AA162032100	32	3,0	11	100
40 × 3,7	m				0,43	1,83	AA162040100	40	3,7	11	100
50 × 4,6	m				0,67	2,75	AA162050100	50	4,6	11	100
63 × 5,8	m				1,05	4,07	AA162063100	63	5,8	11	100
25 × 2,3	m				0,17	0,73	AA162025006	25	2,3	11	6
32 × 3,0	m				0,27	1,10	AA162032006	32	3,0	11	6
40 × 3,7	m				0,43	1,83	AA162040006	40	3,7	11	6
50 × 4,6	m				0,67	2,75	AA162050006	50	4,6	11	6
63 × 5,8	m				1,05	4,07	AA162063006	63	5,8	11	6

FV HDPE 100 RC SDR 17

System: **FV INFRA**
 Material: HDPE
 Standard: ČSN EN 12201-2
 Details: Length 12m on request

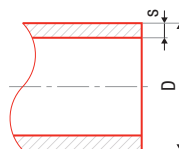

Size	Material	Weight	Volume	Length	Code	D [mm]	s [mm]	SDR	l [m]
32 x 2,0	m	0,19	1,10	AA163032100	32	2,0	17	100	
40 x 2,4	m	0,30	1,83	AA163040100	40	2,4	17	100	
50 x 3,0	m	0,45	2,75	AA163050100	50	3,0	17	100	
63 x 3,8	m	0,72	4,07	AA163063100	63	3,8	17	100	
32 x 2,0	m	0,19	1,10	AA163032006	32	2,0	17	6	
40 x 2,4	m	0,30	1,83	AA163040006	40	2,4	17	6	
50 x 3,0	m	0,45	2,75	AA163050006	50	3,0	17	6	
63 x 3,8	m	0,72	4,07	AA163063006	63	3,8	17	6	

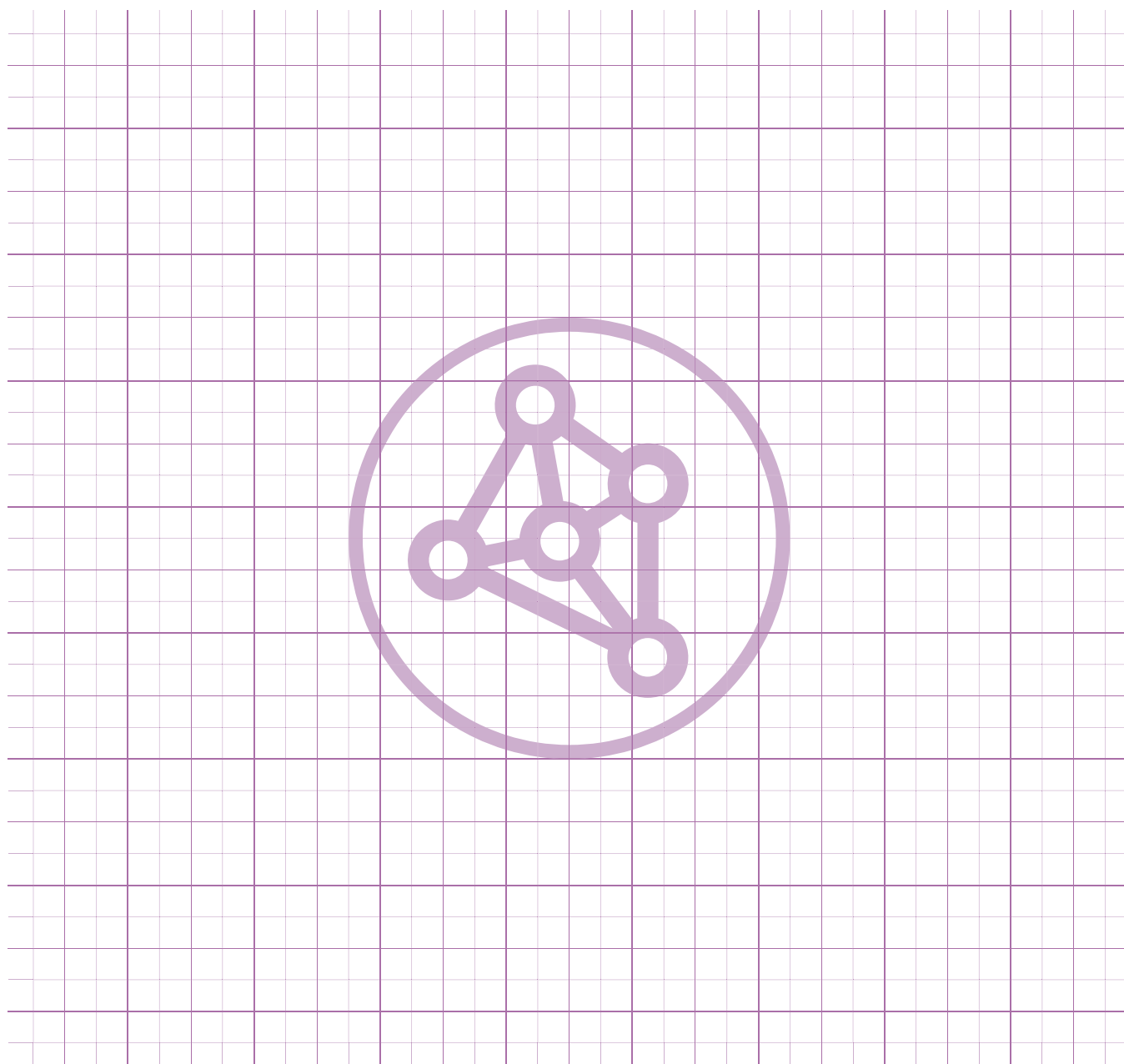

LAYOUT AND CONNECTION ASSEMBLY INSTRUCTIONS

FV HDPE 100 and HDPE 100 RC pipes (resistant to cut) are used mainly for infrastructural water distribution. They are made from high-density polyethylene (HDPE, PEHD or I-PE).

HDPE 100 MRS firmness is 10 MPa – 2.5 times higher than up to now common used low-density polyethylene (LDPE). The wall thickness and hydraulic parameters of the stated pressure decreased considerably. HDPE 100 is more resistant to damage and chemicals and has better characteristics.

HDPE 100 RC pipes are more resistant to cut and damage by point load and are suitable for extreme conditions layout.

FV HDPE PIPING USE

FV HDPE 100 and FV HDPE 100 RC pressure pipes can be used for:

- the distribution of drinking and non-potable water
- the distribution of common cooling and non-freezing mixtures
- the distribution of some water suspension
- the distribution of some chemicals
- the distribution of air and other gases
- the hydro distribution of abrasive materials
- primary circuits and thermal pump exchangers
- snowmaking devices (snow cannons)
- the construction of pressure and vacuum canalization systems

Liquid and loose materials can be distributed if the risk of electrostatic charge is not imminent. HDPE piping is resistant to the common chemicals, the distribution of drinking water from organic matter highly contaminated soil is not recommended.

LAYOUT

Layout method	FV HDPE 100	FV HDPE 100 RC
“Sand“ trench layout	no risk	no risk
Trench layout, grain to 200mm	unsuitable	moderate risk
Relining smooth inner surface pipe	no risk	no risk
Relining pipe unspecified inside	unsuitable	moderate risk
Plowing	unsuitable	moderate risk
Milling	unsuitable	moderate risk
Controlled underdrilling*	unsuitable	moderate risk

ČSN EN 805 requirements regarding construction, lines and safety belt spacing need to be followed when placing the layout.

The drinking water distribution pipes are placed into non-frozen depth as per ČSN 73 6005:

- On the sidewalk and free terrain outside built-up area between 1.00 - 1.60 m (regarding the type and character of soil).
- On the road minimum of 1.5 m.

Taking measures against water piping freezing using an insulation or heating is required in case of shallow mounting.

Piping anchoring is needed in case of a lengthwise slant over 15 % depending on geological ratio.

Piping length dilatations are not necessary to deal with in case of soil mounting. Dilatation compensations are required in case of piping layout above ground and in buildings because of a high thermal expansivity coefficient (0.2 mm/m.K).

Piping trench and mounting is important. The trench width has to enable safe pipe manipulation including its connection and sufficient soil compaction in the pipe surroundings.

The trench width depends on piping diameter and required trench depth.

TRENCH MINIMAL WIDTH AS PER PIPING DIAMETER:

d [mm]	Trench minimal width D + x [m]		
	supported trench	non-supportive trench	
		$\beta > 60^\circ$	$\beta \leq 60^\circ$
≤ 225	D + 0,40	D + 0,40	D + 0,40
> 225 až ≤ 350	D + 0,50	D + 0,50	D + 0,40
> 350 až ≤ 700	D + 0,70	D + 0,70	D + 0,40

d – pipe outer diameter [mm], D – pipe outer diameter [m], β – non-supported trench wall angle. The lowest working spacing between pipe wall and (supported) trench wall is $x / 2$.

TRENCH MINIMAL WIDTH AS PER TRENCH DEPTH:

Grove depth [m]	Minimal width [m]
$> 1,00$	not prescribed
$\geq 1,00$ až $\leq 1,75$	0,80
$> 1,75$ až $\leq 4,00$	0,90
$> 4,00$	1,00

The soil under the pipe and to 15 cm above pipe upper margin is considered effective (see schematic sectional views of mounting). Embankment and compaction is made layer after layer, always on pipe's both sides. The pipes of 110 mm diameter or higher are compacted manually or using soft-compacting machinery. Compaction is not used directly above the pipe to the height of 30 cm. When compacting, the pipes cannot be moved vertically or horizontally.

PE 100RC pipes can be used for so called “non-sand layout” for most common trenches and covered by dig material to 50 % of aggregate additives of the size to 250 mm.

The PE100 pipes are placed into the trench on sand or sandy gravel base of minimal thickness of $L = 10$ cm. The soil does not need to be compacted, although it cannot be too loosen. The effective layer gritting is made by sand or soil without sharp-edged parts for the HDPE 100 piping and pipe fittings.

The pipes cannot be placed on the frozen soil. The entire pipes have to lay on the terrain, without point contact with the rock - assembly holes are created in case of the mechanical pipe fittings or the electrofusion pipe fittings. Mounting angle should be larger than 90° .

The new sand or sandy gravel base has to be created for the pipes (excluding RC pipes) in rock or stone bedrock after removing approximately 15 cm layer.

For pipe fittings gritting, the sand is used for each type of piping if not stated differently. The gritting should exceed the pipe fitting by 20 cm minimum on each side.

The pipes CANNOT be placed directly on concrete or other hard surfaces. If the concrete sheets are used in soils of low-bearing capacity, the 15 cm sand or sandy gravel base has to be created.

PIPING GRITTING AND BACKFILL

The soil corresponding with the specification for the effective layer and given type of piping is used. Hollows cannot emerge in the pipe surroundings, thus, materials that can change their volume or consistency cannot be used for backfill.

Water pipes cannot go through the soil contaminated by organic material. This soil cannot be used for gritting. The unsuitable soil has to be replaced with suitable soil.

A warning foil marking the pipes it recommended as per ČSN 73 6006 (8/2003). The foil should be placed above the pipe top in 20 cm minimum.

The material and compaction method corresponding to the use of given area is used for the pipes upper backfill. It is possible to compact above the pipe from 30 cm covering.

INDEX

FV PP-RCT UNI	14	FV PPR joining elbow 90° to the radiator	37
FV PP-RCT FASER COOL	14	FV PPR sleeve euroconus with metal thread	37
FV PP-RCT HOT	15	FV PPR ball valve plastic with a butterfly	38
FV PP-RCT FASER HOT	15	FV PPR ball valve plastic with a lever	38
FV PP-RCT STABIOXY	15	FV PPR FV PPR ball valve plastic with PV valve	38
FV PPR CLASSIC S2,5 SDR6 (PN 20) 4m	16	FV PPR radiator ball valve straight	38
FV PPR CLASSIC S2,5 SDR6 (PN 20) 3m	16	FV PPR radiator ball valve elbow	38
FV PPR CLASSIC S3,2 SDR7,4 (PN 16) 4m	16	FV PPR ball valve with threaded elbow for hose connection	39
FV PPR CLASSIC S3,2 SDR7,4 (PN 16) 3m	17	FV PPR valve with threaded elbow for hose connection	39
FV PPR CLASSIC - PIPE IN COIL	17	FV PPR straight-way valve	39
FV PPR FASER S2,5 SDR6 (PN 20) 4m	18	FV PPR straight-way valve with PV valve	39
FV PPR FASER S2,5 SDR6 (PN 20) 3m	18	FV PPR angle straight-way valve	40
FV PPR compensation pipe	22	FV PPR angle straight-way valve with PV valve	40
FV PPR crossover	22	FV PPR angle straight-way valve with back flow	40
FV PPR crossover with socket	22	FV PPR back flow valve	40
FV PPR elbow 90°	23	FV PPR filter	41
FV PPR elbow 90° reduced	23	FV PPR shut off valve lux straight with chrome handle	41
FV PPR elbow 45°	23	FV PPR shut off valve straight with cover	41
FV PPR elbow 90° internal / external	23	FV PPR inside the valve	41
FV PPR elbow 45° internal / external	24	FV PP-RCT butt welding elbow 90°	42
FV PPR elbow 90° for wall mounting welding	24	FV PP-RCT butt welding elbow 45°	42
FV PPR reduction internal / external	24	FV PP-RCT butt welding reduction	42
FV PPR three-way elbow	25	FV PP-RCT electro-fusion socket	42
FV PPR socket	25	FV PP-RCT butt welding tee	43
FV PPR reduction	25	FV PP-RCT polyfusion/butt welding tee reduced	43
FV PPR bend	25	FV PP-RCT butt welding blinding	43
FV PPR tee	26	FV PP-RCT weld in saddle polyfusion	43
FV PPR tee reduced	26	FV PP-RCT weld in saddle with metal male thread polyfusion	44
FV PPR cross piece	26	FV PP-RCT weld in saddle with metal female thread polyfusion	44
FV PPR reducing sleeve with plastic male thread	27	FV PP-RCT butt welding flange adaptor	44
FV PPR tap elbow for welding internal	27	FV PP-RCT flange	45
FV PPR threaded tap connector (fast)	27	Welding machine 650W for non-paired adapter Ø16-Ø63	48
FV PPR blinding	27	Welding machine 850W for paired adapter Ø16-Ø75	48
FV PPR threaded tap connector	28	Dytron Welder Polys P-4 650W	48
FV PPR blinding internal	28	Dytron Welder Polys P-4 850W	48
FV PPR pressure plug short	28	Dytron Welder Polys P-4 1200W	48
FV PPR all plastic weld in saddle	28	Dytron Welder Polys P-1b 500W	49
FV PPR washer	29	Mini set SM 21 M	49
FV PPR pressure plug long	29	Mini set SM 41 M	49
FV PPR elbow 90° with metal female thread	30	Profi set SE 21 P	49
FV PPR reducing sleeve with metal male thread	30	Profi set SE 41 P	49
FV PPR reducing sleeve with metal female thread	30	Adapter paired for SM 41 and SE 41 black	50
FV PPR elbow 90° with metal female thread	31	Adapter paired for SM 41 and SE 41 blue	50
FV PPR weld in saddle with metal male thread	31	Adapter paired for weld in saddle	50
FV PPR weld in saddle with metal female thread	31	Drill for weld in saddle	50
FV PPR reducing sleeve with metal female thread with cross	31	Adapter non-paired for SM 21 and SE 21 black	51
FV PPR tee with metal female thread	32	Adapter non-paired for SM 21 and SE 21 blue	51
FV PPR tee with metal male thread	32	Repairing set	51
FV PPR metal reducer with cap nut	32	Repairing stake	51
FV PPR union plastic / brass unwelded	32	STABIOXY pipes shaver	52
FV PPR plastic reducing sleeve with cap nut	33	Shavers to drill machine for STABIOXY pipes	52
FV PPR coupling with nut	33	Cordless pipe shears d40	52
FV PPR elbow 90° plastic reducing sleeve with cap nut	33	Pipe cutter REMS	52
FV PPR tee plastic reducing sleeve with cap nut	33	Shears	53
FV PPR flange adaptor	34	Tightening spanner with belt	53
FV PPR flange	34	Spiral for sewer cleaning	53
FV PPR transition union male	34	Assembly MP 75	53
FV PPR transition union female	34	Assembly MP 110 UD	53
FV PPR elbow 90° for wall mounting	35	Spider 125 with universal clamping	54
FV PPR elbow 90° for wall mounting internal / external	35	Spider Demo stand	54
FV PPR wall mounting elbow with metal female thread LEFT and RIGHT	35	Case for welding machine flat type PROFI	54
FV PPR elbow with metal female thread UNI	35	Case for welding machine flat type MINI	54
FV PPR holder MONO for UNI elbow	35		
FV PPR DUO for UNI elbow	36	FV MULTIPERT-AL pipe in coil	64
FV PPR wall elbows with holder	36	FV MULTIPERT-AL pipe in stick	64
FV PPR elbow for gypsum wall mounting	36	FV MULTIPEX-AL pipe in coil	64
FV PPR tee with tap connector	36	FV MULTIPEX-AL pipe in stick	65
FV PPR wall mounting group with tap connectors	36	FV M-PRESS reducer with cap nut	66
FV PPR assembling plate for elbow 90° for wall mounting	37	FV M-PRESS reducing sleeve with metal female thread	66
FV PPR electro-fusion socket	37	FV M-PRESS reducing sleeve with metal male thread	67
FV PPR joining elbow 45° to the radiator	37	FV M-PRESS join	67
		FV M-PRESS reduction	68

FV M-PRESS elbow 90°	68
FV M-PRESS elbow 45°	68
FV M-PRESS elbow 90° for wall mounting	69
FV M-PRESS running elbow 90° for wall mounting	69
FV M-PRESS running elbow 180° for wall mounting	69
FV M-PRESS elbow 90° with metal female thread	69
FV M-PRESS elbow 90° with metal male thread	70
FV M-PRESS elbow 90° plastic reducing sleeve with cap nut	70
FV M-PRESS wall mounting group with tap connectors for gypsum walls	70
FV M-PRESS wall mounting group with tap connectors	70
FV M-PRESS tee	71
FV M-PRESS tee reduced	71
FV M-PRESS tee with metal female thread	72
FV M-PRESS tee with metal male thread	72
FV M-PRESS shut off ball valve lux straight with chrome handle	72
FV M-PRESS shut off ball valve straight with cover	73
FV M-PRESS joining elbow 90° to the radiator	73
FV M-PRESS reducing sleeve to Cu	73
FV M-PRESS blinding	73
FV P-PRESS reducing sleeve with metal male thread	74
FV P-PRESS reducing sleeve with metal female thread	74
FV P-PRESS reducer with cap nut	74
FV P-PRESS join	75
FV P-PRESS reduction	75
FV P-PRESS elbow 90°	75
FV P-PRESS blinding	75
FV P-PRESS tee	76
FV P-PRESS tee reduced	76
FV P-PRESS manifold 4 circuits	76
FV P-PRESS manifold 5 circuits	77
FV P-PRESS manifold 6 circuits	77
Calibrator for FV P-PRESS metal	78
Calibrator for FV M-PRESS metal	78
Calibrator for FV M-PRESS plastic	78
Calibrator for FV M-PRESS plastic with shaver	78
Bending pipe outer for FV MULTIPIPES	78
Bending pipe inner for FV MULTIPIPES	79
REMS pressing jaws BASIC E 01	79
REMS pressing Mini BASIC E 01	79
TC inserts into universal pressing jaws for fittings FV P-PRESS	79
Pipe insulation Tubex (foamed PE)	82
Adhesive insulation tape	82
Adhesive tape	82
Insulation clip	83
Insulation felt	83
O-ring Taboren	83
Teflon insulation tape	83
Plastic clip PP	84
Plastic double clip PP	84
Plastic clip with stirrup	84
Plastic double clip with stirrup	84
Spacing clamp for cold water	85
Plastic clip with strap	85
Metal sleeve	85
Screw combi	85
Dowels	86
Threaded bar	86
Clamping strap	86
Plastic trough	86
Trough cover plastic	86
Galvanized trough (2 m length)	87
RPE pipe	87

FV MULTIPERT-5	90
FV MULTIPEX-5	90
FV MULTIPERT-AL	90
FV MULTIPEX-AL	91
FV EPS insulated mounting mate in roll	91
FV NOP UNI system mat	91
FV NOP SOLO system mat	91
FV NOP ISO system mat with 11mm insulation	92
FV NOP ISO PLUS system mat with 30mm insulation	92
FV TBS system mat with 25mm for dry construction	92
FV TBSL guide plate	92
FV TBSC reversing arc for mats FV TBS	92
FV RENO special mat for floor reconstruction	93
FV clamping rail	93
FV staple for clamping rail	93
FV manifold with flowmeter	94
FV manifold INOX	94
FV mixing set for 200m ²	95
FV mixing set for 160m ²	95
FV ball valve 1" with male and female tread	95
FV thermometer for manifold	95
FV manifold cabinet on plaster	96
FV manifold cabinet under plaster	96
FV tacker staple	96
FV edge belt	96
FV PE protecting tube	97
FV dilatation belt	97
FV direction diverter	97
FV direction diverter "click"	97
FV fixing plastic bend	97
FV self-adhesive tape	98
FV screed plasticizer	98
FV servodrive	98
FV thermostatic controller	98
FV electronic switching module	98
FV transformer 230/24 V	99
FV flowmeters	99
FV transition union to the distributor (Eurocone 3/4")	99
FV coupling	100
FV reducing sleeve male 3/4"	100
FV plug female 3/4"	100
FV Tacker - fixing gun	100
FV Tacker - fixing gun plastic	101
FV horizontal decoiler	101

NEW BRADO	108
ALTRA	108
SPIDER	109
SPIDER MAXI	109
GIGA	109
NOMO	110
REGA	110
REGO	110
Electrofusion socket SDR 11	111
Electrofusion blinding SDR 11	111
Electrofusion reduction of SDR 11	111
Electrofusion bend 90° SDR 11	112
Insert transition PE - brass female thread SDR 11	112
Insert transition PE - brass male thread SDR 11	112
Insert transition PE - brass with nut SDR 11	113
Electrofusion Y-piece - reducing the number of branches	113
FV ENERGEO GH 12,5	113
FV ENERGEO GH 16	114
FV ENERGEO GH DUO 12,5	114
FV ENERGEO GH DUO 16	114
FV ENERGEO CP HDPE 100RC PN 10	115
FV ENERGEO CP HDPE 100RC PN 12,5	115
FV ENERGEO CP HDPE 100RC PN 16	115
Electrofusion welder with barcode reader	116
Weight	116

FV HDPE 100 SDR11	120
FV HDPE 100 SDR17	120
FV HDPE 100 RC SDR 11	120
FV HDPE 100 RC SDR 17	121



FV - Plast, a.s.

Kozovazská 1049/3	T: +420 326 706 711
250 88 Čelákovice	F: +420 326 706 721
Česká Republika	@: fv-plast@fv-plast.cz

WWW.FV-PLAST.CZ